



Zsuzsanna E. Benedek
Associate General Counsel
240 North Third Street, Ste. 300
Harrisburg, PA 17101
Telephone: 717.775.3088
sue.benedek@centurylink.com

August 31, 2021

VIA ELECTRONIC FILING

Rosemary Chiavetta, Secretary
Pennsylvania Public Utility Commission
Commonwealth Keystone Building
400 North Street
Harrisburg, PA 17120

Re: Application of CenturyTel Broadband Services, LLC for approval to offer, render, furnish or supply telecommunications services to the public in the Commonwealth of Pennsylvania
Docket No.

Dear Secretary Chiavetta:

Enclosed for electronic filing is the Application of CenturyTel Broadband Services, LLC for approval of Certificate of Public Convenience providing local and long-distance services in the Commonwealth of Pennsylvania. As required by the Commission's rules, a filing fee in the amount of \$250.00 is being paid by credit card through the Commission's eFiling system.

I certify that a copy has been sent to all parties of record as indicated by the Certificate of Service. If you have any questions, please do not hesitate to contact me.

Sincerely,

A handwritten signature in black ink, appearing to read "Sue Benedek".

Sue Benedek, Esquire
Attorney ID No. 60451

ZEB/sac
Enclosures

cc: As per Certificate of Service
David Screven, Law Bureau (*via email: dscreven@pa.gov*)
Erin Tate, BCS (*via email: etate@pa.gov*)
Derek Vogelsong, Bureau of Technical Utility Services (*via email: devogelson@pa.gov*)

**BEFORE THE
PENNSYLVANIA PUBLIC UTILITY COMMISSION**

Application of CenturyTel Broadband :
Services, LLC for approval to offer, :
render, furnish or supply : Docket No. _____
telecommunications services to the :
public in the Commonwealth of :
Pennsylvania. :

CERTIFICATE OF SERVICE

I hereby certify that I have this day served a true and correct copy of the foregoing Application dated August 31, 2021, upon the parties listed below in accordance with the requirements of 52 Pa. Code §1.54 (relating to service by a party).

Service by Electronic Mail:

Office of Consumer Advocate
Barrett C. Sheridan
555 Walnut Street
5th Floor, Forum Place
Harrisburg, PA 17101
Email: BSheridan@paoca.org

Office of Small Business Advocate
Steven C. Gray
555 Walnut Street
1st Floor, Forum Place
Harrisburg, PA 17101
Email: sgray@pa.gov

Office of Attorney General
Office of Consumer Protection
Strawberry Square
Harrisburg, PA 17120
Email: jsharp@pa.gov

Armstrong Telephone
Co. – North

- Armstrong Telephone Co. - PA
Shawn Beqaj, Vice President, Regulatory
Policy and Interconnection
One Armstrong Place
Butler, PA 16001
Email: sbeqaj@agoc.com

Citizens Telephone Company
of Kecksburg
Kenneth S. Cutrell, President
P.O. Box 156
Mammoth, PA 15664-0156
Email: ken.cutrell@ctzn.net

- Consolidated Communications of
Pennsylvania Co.
- Marianna and Scenery Hill Telephone
Company
 - Bentleyville Communications
Corporation

Michael Shultz, Sr. V.P. Regulatory &
Public Policy
5 Davis Farm Road
Portland, ME 04103
Email: mike.shultz@consolidated.com

Frontier Communications

- Citizens Telecommunications of New
York, Inc
- Frontier Communications of
Breezewood, LLC
- Frontier Communications of Canton,
LLC
- Frontier Communications –
Commonwealth Telephone Company
LLC
- Frontier Communications of
Pennsylvania, LLC
- Frontier Communications-Lakewood,
LLC
- Frontier Communications-Oswayb
River, LLC

Carl Yastremski
Manager, Regulatory Affairs
100 CTE Drive
Dallas, PA 18612
Email: Carl.yastremski@ftr.com

Hancock Telephone Company
Rob Wrighter, Jr., Vice President
34 Read Street
P.O. Box 608
Hancock, NY 13783
Email: telco@hancock.net

Hickory Telephone Company
Terri Jeffers, Regulatory Director
75 Main Street
Hickory, PA 15340
Email: tlj@hky.com

Ironton Telephone Company
Sonia E. Fink, Vice President and
Secretary
4242 Mauch Chunk Road (Ironton)
Coplay, PA 18037
Email: sfink@ironton.com

Lackawaxen Telecommunications Services
Jim Kail, President & CEO
101 Laurel Highlands Place
Donegal, PA 15628
Email: jjkail@lhtc.net

Laurel Highland Telephone
Company
Jim Kail, President & CEO
101 Laurel Highlands Place
Donegal, PA 15628
Jim Kail, President & CEO
Email: jjkail@lhtc.net

NEP Telephone (North-Eastern PA
Telephone Co.)
Steven Tourje, President, CEO & COO
P.O. Box D
Forest City, PA 18421-0150
Email: stourje@nep.net

North Penn Telephone
Company
Frank Pilling, Vice President & General
Manager
4145 Route 549
Mansfield, PA 16933
Email: fpilling@etcnpt.com

Palmerton Telephone
Company
David L. Masenheimer, President
P.O. Box 215
Palmerton, PA 18071
Email: dmasenheimer@pencor.com

Pennsylvania Telephone
Company
Kim Hannan, Vice President
191 Middle Road
Jersey Shore, PA 17740
Email: kim.hannan@ptcbb.com

Pymatuning Independent
Telephone Company
Adam Dixon, Chief Operating Officer
120 E. 1st Street
Lewisville, AR 71845
Email: adixon@townes.net

South Canaan Telephone
Company
Jim Kail, President & CEO
101 Laurel Highlands Place
Donegal, PA 15628
Email: jjkail@lhtc.net

TDS Telecom

- Deposit Telephone Company
- Mahanoy & Mahantango Telephone
Company
- Sugar Valley Telephone Company
Bruce Mottern, Manager
State Government Affairs
10025 Investment Dr
Knoxville, TN 37932
Email: bruce.mottern@tdstelecom.com

Venus Telephone
Corporation
P.O. Box 75
1698 County Line Road
Venus, PA 16364
Tim Keister, Vice President - Operations
Email: tkeister@venustel.com

Verizon
Suzan D. Paiva
Associate General Counsel
900 Race St., 6th Floor
Philadelphia, PA 19107
Email: suzan.d.paiva@verizon.com

West Side Telecommunications
John R. Ludenia, Vice President & General
Manager
1449 Fairmont Rd.
Morgantown, WV 26501
Email: jludenia@westsidetel.com

Windstream Communications

- Windstream Buffalo Valley
- Windstream Conestoga, Inc.
- Windstream D&E, Inc.
- Windstream Pennsylvania, LLC

Jeanne Shearer, Vice President of State
Government Affairs
124 East Main Street
Ephrata, PA 17522
Email: jeanne.shearer@windstream.com

Yukon-Waltz Telephone
Company

Jim Kail, President & CEO
101 Laurel Highlands Place
Donegal, PA 15628
Email: jjkail@lhtc.net

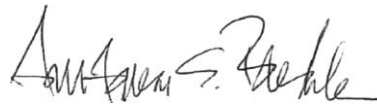

Zsuzuanna E. Benedek
Attorney ID No. 60451

Dated: August 31, 2021

Application of: CenturyTel Broadband Services, LLC for approval to offer, render, furnish or supply telecommunications services to the public in the Commonwealth of Pennsylvania.

- 1. IDENTITY OF THE APPLICANT:** The name, address, telephone number, and fax number of the Applicant.

**CenturyTel Broadband Services, LLC
100 CenturyLink Drive
Monroe, LA 71203
800-871-9244
www.lumen.com**

Please identify any predecessors of the Applicant and provide other names under which the Applicant has operated within the preceding five years, including name, address, and telephone number.

CenturyTel Broadband Services, LLC (“CTBS”) was formed on October 21, 1999 in the State of Louisiana. CTBS is a direct, wholly-owned subsidiary of Lumen Technologies, Inc. In the preceding five years, CTBS has operated in some states (other than Pennsylvania) under the fictitious name, “d/b/a CenturyLink.”

**CTBS Address:
CenturyLink
100 CenturyLink Drive
Monroe, LA 71203**

- 2. ATTORNEY:** The name, address, telephone number, and fax number of the Applicant’s attorney.

**Zsuzsanna E. Benedek
Associate General Counsel
240 North Third Street, Ste. 300
Harrisburg, PA 17101
Telephone: 717.775.3088
sue.benedek@lumen.com**

- 3. CONTACTS:**

- A) APPLICATION:** The name, title, address, telephone number, and fax number of the person to whom questions about this application should be addressed.

**Sue Benedek, Esquire
240 North Third Street, Ste. 300
Harrisburg, PA 17101
Telephone: 717.775.3088
sue.benedek@centurylink.com**

And,

Joshua S. Motzer
Director State and Local Government Affairs
37 W. Broad St., Ste. 470
Columbus, OH 43215
614-441-0393
Josh.Motzer@lumen.com

B) PENNSYLVANIA EMERGENCY MANAGEMENT AGENCY (PEMA):
The name, title, address, telephone number and FAX number of the person with whom contact should be made by PEMA (Pennsylvania Emergency Management Agency).

Joshua S. Motzer
Director State and Local Government Affairs
37 W. Broad St., Ste. 470
Columbus, OH 43215
614-441-0393
Josh.Motzer@lumen.com

Brett Biggica
Government Affairs Director
240 N 3rd Street, Ste. 300
Harrisburg, PA 17101
717-775-3110
brett.biggica@lumen.com

C) RESOLVING COMPLAINTS: Name, address, telephone number, and FAX number of the person and an alternate person responsible for addressing customer complaints. These persons will ordinarily be the initial point(s) of contact for resolving complaints and queries filed with the Public Utility Commission or other agencies.

CenturyTel Broadband Services, LLC
100 CenturyLink Drive
Monroe, LA 71203
<https://www.centurylink.com/home/help/contact.html>
800-201-4099 (tollfree for customer service and repair)

Informal complaint processing:

Similar to its PA ILEC affiliate, The United Telephone Company of Pennsylvania LLC d/b/a CenturyLink, the Applicant will utilize Pennsylvania's PUC Electronic Response Complaint System ("PERCS") to respond to potential informal complaints. The Applicant will register in the system with the email address to its Customer Advocacy Group of uswpuc@centurylink.com for all communications to and from the PAPUC (BCS) regarding informal complaints.

Escalation contacts for complaints

Joshua S. Motzer
Director State and Local Government Affairs
37 W. Broad St., Ste. 470
Columbus, OH 43215
614-441-0393
Josh.Motzer@lumen.com

Brett Biggica
Government Affairs Director
240 N 3rd Street, Ste. 300
Harrisburg, PA 17101
717-775-3110
brett.biggica@lumen.com

4. FICTITIOUS NAME:

The Applicant will not be using a fictitious name.

The Applicant will be using a fictitious name. Attach to the Application a copy of the Applicant's filing with the Commonwealth's Department of State pursuant to 54 Pa. C.S. § 311, Form PA-953.

5. BUSINESS ENTITY AND DEPARTMENT OF STATE FILINGS: Applicant has registered its business with the Pennsylvania Department of State. Please check the appropriate registration type for Applicant as designated with the Department.

- Sole proprietor
- Domestic general partnership
- Domestic corporation
- Domestic limited partnership
- Domestic limited liability company
- Domestic limited liability partnership
- *Foreign corporation
- *Foreign general or limited partnership
- *Foreign limited liability company**
- *Foreign limited liability general partnership
- *Foreign limited liability limited partnership

*Provide name and address of Corporate Registered Office Provider or Registered Office within PA.

CT Corporation System
600 N 2nd St., Ste. 401
Harrisburg, PA 17101

Attach to the application the name and address of partners. If any partner is not an individual, identify the business nature of the partner entity and identify its partners or officers.

N/A

Attach to the application proof of compliance with appropriate Department of State filing requirements as indicated above. Additionally, provide a copy of the Applicant's Articles of Incorporation or a Certificate of Organization.

The Applicant is incorporated in the State of Louisiana.

See, Exhibit 1 for PA Department of State filings and CTBS Articles of Incorporation (Louisiana).

Give name and address of officers:

See Exhibit 2 for list of Directors and Officers.

The Managers of CTBS are Jeffrey K. Storey and Andrea L. Genschaw. Biographies of key management personnel of Lumen and CTBS can be found on Lumen's website at <https://news.lumen.com/executive-bios>.

6. AFFILIATES AND PREDECESSORS WITHIN PENNSYLVANIA:

The Applicant has no affiliates doing business in Pennsylvania or predecessors which have done business in Pennsylvania.

X The Applicant has affiliates doing business in Pennsylvania or predecessors which have done business in Pennsylvania. Name and address of the affiliates. State whether they are jurisdictional public utilities. Give docket numbers for the authority of such affiliates.

If the Applicant or an affiliate has predecessors who have done business within Pennsylvania, give name and address of the predecessors and state whether they were jurisdictional public utilities. Give the docket numbers for the authority of such predecessors.

Affiliates:

- 1. The United Telephone Company of Pennsylvania LLC d/b/a CenturyLink – This entity is a long-standing certificated Incumbent Local Exchange Carrier (ILEC) in Pennsylvania. CenturyLink continues to operate as an ILEC in Pennsylvania. As an ILEC, this entity predated the Commission's current docket system.**
- 2. CenturyLink Communications, LLC – This entity is certificated both as an Interexchange Carrier and a Competitive Local Exchange Carrier in Pennsylvania. (Docket Nos: A-2013-2398872, A-2013-2398896, A-2013-2398897.)**

3. **Level 3 Communications, LLC** – This entity is authorized to provide facilities-based local exchange, interexchange and competitive access services within Pennsylvania pursuant to authorization granted in Docket No. A-3106333.
4. **Broadwing Communications, LLC** – This entity is authorized to provide interexchange, competitive local exchange and competitive access telecommunications services pursuant to authorization granted in Docket Nos. A-310287, A-31258F0002, A-31258F0003.
5. **Global Crossing Telecommunications, Inc.** – This entity is authorized to provide intrastate telecommunications service pursuant to authority granted in Docket No. A-310112.
6. **Global Crossing Local Services, Inc.** – This entity is authorized to provide intrastate telecommunications service pursuant to authority granted in Docket No. A-310703.
7. **TelCove Operations, LLC** – This entity is authorized to provide resold interexchange, local exchange and competitive access and facilities-based interexchange telecommunications service pursuant to authorization granted in Docket Nos. A-310932, A-310932F0002, A-310932F0003 and A-310932F0004.
8. **Telcove of Pennsylvania, LLC** – This entity is authorized to provide resold interexchange, local exchange and competitive access services and facilities-based interexchange telecommunications services in Pennsylvania pursuant to authorization granted in Docket No. A-310470.
9. **WilTel Communications, LLC** – This entity is authorized to provide resold interexchange, local exchange, and competitive access and facilities-based interexchange telecommunications service pursuant to authorization granted in Docket No. A-310690.
10. **Level 3 Telecom Data Services, LLC** – This entity is authorized to provide telecommunications services as a competitive local exchange carrier in the service territory of Verizon Pennsylvania and to operate as a Competitive Access Provider pursuant to authorization granted in UC-3110608, Docket Numbers A-2010-2181492, A-2010-2181491, and A-2008-2075535. The company's name was changed from tw telecom data services llc to Level 3 Telecom Data Services, LLC, which was approved in Docket Nos. R-2016-2544409, R-2016-2544416 and R-2016-2544417.

Predecessors:

The foregoing Commission-certificated entities arise from a series of transactions and internal reorganizations, all of which have been subject to approvals and orders entered by the Commission. In descending order since 2005, the transactions/reorganizations and the associated predecessors are addressed in the following Commission orders:

1. *Joint Application for the Transfer of Control of Level 3 Communications, Inc., together with Level 3 Communications, LLC, TelCove Operations, LLC, TelCove of Pennsylvania, LLC, Broadwing Communications, LLC, WilTel Communications, LLC, Global Crossing Telecommunications, Inc., Global Crossing Local Services, Inc., and Level 3 Telecom Data Services, LLC, to Transferee, CenturyLink, Inc.* Docket Nos. A-2016-2580274, A-2016-2580275, A-2016-2580276, A-2016-2580277, A-2016-2580278, A-2016-2580279, A-2016-2580280 and A-2016-258028, Order entered June 14, 2017.
2. By Secretarial Letter dated February 27, 2013 (Docket Numbers: A-2013-2398872, A-2013-2398896, A-2013-2398897), the Commission approved a Joint Application and granted all approvals necessary to effectuate an internal corporate restructuring of CLEC and IXC subsidiaries and affiliates. CenturyLink Communications, LLC is operating today in Pennsylvania. That internal corporate restructuring extinguished certificates of public convenience held by the following two IXCs:
 - Embarq Communications, Inc. d/b/a CenturyLink Communications *See also, Application of Sprint Long Distance, Inc. for approval to offer, render, furnish or supply telecommunications services as an Interexchange Toll Reseller to the Public in the Commonwealth of Pennsylvania, Docket No. A-311379, Order entered October 11, 2005.*
 - CenturyTel Long Distance, LLC d/b/a CenturyLink Long Distance *See also, Application of CenturyTel Long Distance, LLC for approval to offer, render, furnish or supply telecommunication services as a Facilities-based Interexchange Carrier to the public in the Commonwealth of Pennsylvania, Docket No. A-2010-2200137, Order entered November 4, 2010.*
3. *Joint Application for Approval Under Chapter 11 of the Pennsylvania Public Utility Code of the Change of Control of Qwest Communications Co., LLC and for all Other Approvals Required Under the Public Utility Code, Docket No. A-2010-2176733, Order entered October 14, 2010.*
4. *Joint Application of The United Telephone Company of Pennsylvania LLC d/b/a Embarq Pennsylvania and Embarq Communications, Inc. for approval of the Indirect Transfer of Control To CenturyTel, Inc. Docket No. A-2008-2076038 Order entered November 25, 2009.*
5. *Joint Application of The United Telephone Company of Pennsylvania d/b/a Sprint, and Of Sprint Long Distance, Inc., for all Approvals Required under the Pennsylvania Public Utility Code in Connection with Changes Of Control of The United Telephone Company Of Pennsylvania d/b/a Sprint and of Sprint Long Distance, Inc., Docket Nos. A-313200F0007 and A-311379F0002, Order entered March 22, 2006.*

7. AFFILIATES AND PREDECESSORS RENDERING PUBLIC UTILITY SERVICE OUTSIDE PENNSYLVANIA:

The Applicant has no affiliates rendering or predecessors which rendered public utility service outside Pennsylvania.

X The Applicant has affiliates rendering or predecessors which rendered public utility service outside Pennsylvania. Name and address of the affiliates and predecessors (please identify affiliates versus predecessors).

A current list of certificated affiliates operating in other states is set forth in Exhibit 3.

8. APPLICANT'S PRESENT OPERATIONS: (Select and complete the appropriate statement)

X The applicant is not presently doing business in Pennsylvania as a public utility.

The applicant is presently doing business in Pennsylvania as a:

Interexchange Toll Reseller, InterLATA and/or IntraLATA, (e.g., MTS, 1+, 800, WATS, Travel and Debit Cards)

Interexchange Toll Facilities-based carrier, InterLATA and/or IntraLATA, (e.g., MTS, 1+, 800, WATS, Travel and Debit Cards)

Competitive Access Provider (dedicated point-to-point or multipoint service; voice or data)

Competitive Local Exchange Carrier.

Incumbent Local Exchange Carrier.

Other (Identify).

9. APPLICANT'S PROPOSED OPERATIONS: The Applicant proposes to operate as:

X Interexchange Toll Reseller, InterLATA and/or IntraLATA, (e.g., MTS, 1+, 800, WATS, Travel and Debit Cards)

X Interexchange Toll Facilities-based carrier, InterLATA and/or IntraLATA, (e.g., MTS, 1+, 800, WATS, Travel and Debit Cards)

Competitive Access Provider (dedicated point-to-point or multipoint service; voice or data)

X Competitive Local Exchange Carrier.

- Incumbent Local Exchange Carrier
 Other (Identify). VoIP

10. **PROPOSED SERVICES:** Describe in detail the services which the Applicant proposes to offer. If proposing to provide more than one category in Item #9, clearly and separately delineate the services within each proposed operation. Provide a brief description of the facilities the Company will use to provide services. Specify whether those facilities are Company-owned or obtained from other companies as UNEs or on a resold basis.

CLEC/VoIP for Lifeline services as an ETC under FCC RDOF Program:

Applicant, CTBS, initially seeks a certificate of public convenience to operate as a Competing Local Exchange Carrier (“CLEC”) in order to become designated as an Eligible Telecommunications Carrier (“ETC”) for purposes of receiving federal universal service support from the FCC Rural Digital Opportunity Fund (“RDOF”). *Rural Digital Opportunity Fund Phase I Auction (Auction 904) Closes, Winning Bidders Announced*, AU Docket No. 20-34, Public Notice, 35 FCC Rcd 13888 DA No. 20-1422 (OEA/WCB rel. Dec. 7, 2020). In this regard, Applicant proposes to provision voice telephony, where requested by a customer, using Voice-over-Internet Protocol (“VoIP”) technology. Applicant ultimately proposes to provide VoIP services as a CLEC in the areas (the “Incremental Census Blocks”) that are subject to a pending petition for ETC designation made by Level 3 Communications, LLC at PA PUC Docket No. P-2021-3024219. CTBS will also offer standalone voice services to the public in the Incremental Census Blocks.

CTBS presently is not a designated ETC in Pennsylvania and does not have network facilities in Pennsylvania. Upon obtaining certificates of public convenience, CTBS will make a request of the Commission to be the designated the ETC, in lieu of Level 3, for RDOF award and obligation purposes in the Incremental Census Blocks identified in the pleadings and responses to discovery submitted by Level 3 at PA PUC Docket No. P-2021-3024219. CTBS files this application and plans to request ETC designation in the Incremental CBs Docket No. P-2021-3024219 so that it may extend voice and broadband services to the Incremental Census Blocks by building a fiber-to-the-premise network and reselling voice services in advance of construction.

Statewide CLEC & IXC services / resale and facilities-based:

Applicant, CTBS, seeks certificates of public convenience to operate as a Competing Local Exchange Carrier (“CLEC”) and as an Interexchange Carrier (“IXC”) for the provision of these services throughout Pennsylvania. CTBS, either through its own facilities or through facilities and services of another carrier/affiliate, will offer a complete range of CLEC and IXC services.

If this application is approved, Applicant will be an affiliate of The United Telephone Company of Pennsylvania LLC d/b/a CenturyLink (“United”), which is certificated and operates as an ILEC in portions of Pennsylvania. Applicant files for statewide CLEC and IXC services as it plans to provision services as an affiliate of

United in conjunction with yet-to-be filed Commission approval of a recently announced transaction involving the indirect transfer of control of United and CTBS. *See generally*, announcement of Apollo Global Management, Inc. and Lumen Technologies, Inc. (f/k/a CenturyLink, Inc.): <https://www.reuters.com/business/media-telecom/telecom-firm-lumen-sell-some-us-business-75-blm-deal-2021-08-03/> Applicant is expected to continue to remain an affiliate of United following regulatory approvals of the proposed Apollo transaction.

In sum, CTBS initially plans to operate as a reseller and will enter into any necessary agreement(s) for this purpose. Ultimately, Applicant may build a network in areas outside the territory of its Pennsylvania ILEC affiliate, United. Thus, Applicant requests reseller and facilities-based authorization in this Application.

11. **SERVICE AREA:** Describe the geographic service area in which the Applicant proposes to offer services. Clearly and separately delineate the service territory for each category listed in Item #9. For Competitive Local Exchange Carrier operations, you must name and serve the Incumbent Local Exchange Carriers in whose territory you request authority.

Applicant is requesting certification for each category in Item #9 in the territories of:

Armstrong Telephone Co.-North
Armstrong Telephone Co.- PA
The Bentleyville Telephone Co.
Citizens Telephone Co. of Kecksburg
Citizens Telecommunications of New York, Inc.
Consolidated Communications Company of Pennsylvania
Frontier Communications of Breezewood, LLC
Frontier Communications of Canton, LLC
Frontier Communications - Commonwealth Telephone Company LLC
Frontier Communications of Pennsylvania, LLC
Frontier Communications-Lakewood, LLC
Frontier Communications-Oswayb River, LLC
Hancock Telephone Co.
Hickory Telephone Co.
Ironton Telephone Co.
Lackawaxen Telephone Co.
Laurel Highland Telephone Co.
Marianna and Scenery Hill Telephone Co.
North Penn Telephone Co.
North-Eastern PA Telephone Co.
Palmerton Telephone Co.
Pennsylvania Telephone Co.
Pymatuning Independent Telephone Co.
South Canaan Telephone Co.,
TDS Mahanoy & Mahantango Telephone Co.
TDS SugarValley Telephone Co.

**TDS Telecom/Deposit Telephone Co.,
The United Telephone Company of Pennsylvania LLC d/b/a CenturyLink
Venus Telephone Corp.,
West Side Telecommunications
Windstream Buffalo Valley
Windstream Conestoga, Inc.,
Windstream D&E, Inc.
Windstream Pennsylvania, LLC
Yukon Waltz Telephone Co.**

And:

**Verizon Pennsylvania LLC
Verizon North LLC**

****Copies of this application has been served via electronic mail upon known representatives of the foregoing ILECs.**

- 12. MARKET:** Describe the customer base to which the Applicant proposes to market its services. Clearly and separately delineate a market for each category listed in Item #9.

See response to #10 above, incorporated herein. In sum, Applicant initially seeks a CLEC certificate of public convenience in order to become designated as an ETC, in lieu of another CLEC (Level 3), for RDOF award and obligation purposes in the Incremental Census Blocks identified in the pleadings and responses to discovery submitted at PA PUC Docket No. P-2021-3024219, which is pending before the Commission. In addition, CTBS seeks CLEC and IXC certificates of public convenience to be able to offer services to both residential and business customers, as addressed in response to #10 above.

- 13. PROPOSED TARIFF(S):** Each category of proposed operations must have a separate and distinct proposed tariff setting forth the rates, rules and regulations of the Applicant. Every proposed tariff shall state on its cover page the nature of the proposed operations described therein, i.e., IXC Reseller, CLEC, CAP, or IXC Facilities-based. A copy of all proposed tariffs must be appended to each original and duplicate original and copy of Form 377.

A copy of the proposed CLEC tariffs are attached heretofore Exhibit 4. Pursuant to 66 Pa. C.S. §3018(B)(2), Applicant seeks to operate as a detariffed interexchange company.

- 14. FINANCIAL:** *Attach the following to the Application:*

A general description of the Applicant's capitalization and, if applicable, its corporate stock structure;

Current balance sheet, Income Statement, and Cash Flow Statement of Applicant or Affiliated Company, if relying on affiliate for financial security;

A tentative operating balance sheet and a projected income statement for the first year of operation within the Commonwealth of Pennsylvania; provide the name, title, address,

telephone number and fax number of the Applicant's custodian for its accounting records and supporting documentation; and indicate where the Applicant's accounting records and supporting documentation are, or will be, maintained.

If available, include bond rating, letters of credit, credit reports, insurance coverage and reports, and major contracts.

The Applicant is a wholly-owned subsidiary of Lumen Technologies, Inc. Information about Lumen Technologies, Inc.'s consolidated financial status, operations, management, and services is set forth in its most recent annual report, which is available:

https://s24.q4cdn.com/287068338/files/doc_financials/2021/ar/Lumen-2020-Annual-Report-and-2021-Proxy-Statement.pdf

15. **START DATE:** The Applicant proposes to begin offering services on or about:

As addressed in #10 above and incorporated herein, it is Applicant's intent to begin offering services pursuant to any assumption of obligations and funding associated with the FCC's RDOF program in the Incremental Census Blocks addressed at the matter pending at Docket No. P-2021-3024219. FCC RDOF funding for Applicant's ILEC affiliate, The United Telephone Company of Pennsylvania LLC d/b/a CenturyLink, is anticipated to occur after January, 2022. CTBS thereafter intends to begin to offer resale local and long distance authority. Facilities-based are under evaluation and will be offered once CTBS begins to deploy its own network facilities.

16. **FURTHER DEVELOPMENTS:** Attach to the Application a statement of further developments, planned or contemplated, to which the present Application is preliminary or with which it forms a part, together with a reference to any related proceeding before the Commission.

Not applicable.

17. **NOTICE:** Pursuant to 52 Pa. Code § 5.14, you are required to serve a copy of the signed and verified Application, with attachments, on the below-listed parties, and file proof of such service with this Commission:

Office of Consumer Advocate
555 Walnut Street
5th Floor, Forum Place
Harrisburg, PA 17101

Office of Small Business Advocate
555 Walnut Street
1st Floor, Forum Place
Harrisburg, PA 17101

Office of Attorney General
Office of Consumer Protection
Strawberry Square
Harrisburg, PA 17120

A certificate of service must be attached to the Application as proof of service that the Application has been served on the above-listed parties. A copy of any Competitive Local Exchange Carrier Application must also be served on any and/or all Incumbent Local Exchange Carrier(s) in the geographical area where the Applicant proposes to offer services.

18. **FEDERAL TELECOMMUNICATIONS ACT OF 1996:** State whether the Applicant claims a particular status pursuant to the Federal Telecommunications Act of 1996. Provide supporting facts.

Not applicable.

19. **COMPLIANCE:** State specifically whether the Applicant, an affiliate, a predecessor of either, or a person identified in this Application has been convicted of a crime involving fraud or similar activity. Identify all proceedings, limited to proceedings dealing with business operations in the last five (5) years, whether before an administrative body or in a judicial forum, in which the Applicant, an affiliate, a predecessor of either, or a person identified herein has been a defendant or a respondent. Provide a statement as to the resolution or present status of any such proceedings.

Neither the Applicant nor any affiliate, predecessor, or person identified in this Application has been convicted of a crime involving fraud or similar activity. To the best of Applicant's knowledge, information and belief, there have been no proceedings in the last five years finding that the Applicant, or an affiliate thereof, cannot continue with its business operations.

20. **FALSIFICATION:** The Applicant understands that the making of false statement(s) herein may be grounds for denying the Application or, if later discovered, for revoking any authority granted pursuant to the Application. This Application is subject to 18 Pa. C.S. §§ 4903 and 4904, relating to perjury and falsification in official matters.

Applicant so understands.

21. **CESSATION:** The Applicant understands that if it plans to cease doing business within the Commonwealth of Pennsylvania, it is under a duty to request authority from the Commission for permission prior to ceasing business.

Applicant:

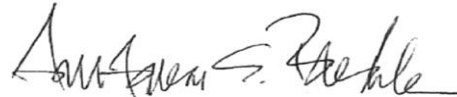

Zsuzsanna E. Benedek, Esquire
Associate General Counsel (Atty ID 60451)
240 North Third Street, Ste. 300
Harrisburg, PA 17101
Telephone: 717.775.3088
sue.benedek@lumen.com

22. **AFFIDAVIT:** Attach to the Application an affidavit as follows:

AFFIDAVIT

State of OHIO :
 : ss.
County of FRANKLIN :

JOSHUA S. MOTZER, Affiant, being duly [sworn/affirmed] according to law, deposes and says that:

Affiant is the Director State and Local Government Affairs of CenturyTel Broadband Service, LLC.

That Affiant is authorized to and does make this affidavit for said corporation;

That CenturyTel Broadband Service, LLC, the Applicant herein, acknowledges that [he/she/it] may have an obligation to serve or to continue to serve the public by virtue of the Applicant commencing the rendering of service pursuant to this Application consistent with the Public Utility Code of the Commonwealth of Pennsylvania, Title 66 of the Pennsylvania Consolidated Statutes; with the Federal Telecommunications Act of 1996, signed February 6, 1996, or with other applicable statutes or regulations;

That CenturyTel Broadband Service, LLC, the Applicant herein, asserts that Affiant possesses the requisite technical, managerial, and financial fitness to render public utility service within the Commonwealth of Pennsylvania and that the Applicant will abide by all applicable federal and state laws and regulations and by the decisions of the Pennsylvania Public Utility Commission.

*** Next paragraph for CLEC Applicants ONLY:**

That CenturyTel Broadband Service, LLC, the Applicant herein, asserts that Affiant has contacted the appropriate 911 Coordinator(s) via certified letter, from the list provided from the PUC website (<http://www.puc.pa.gov>), and that arrangements are under way for the provisioning of emergency 911 service in each of the Counties/Cities where service is to be provided. The applicant certifies Affiant has attached a copy of the 911 Coordinator list indicating each 911 Coordinator contacted.

That the facts above set forth are true and correct] to the best of [Affiant knowledge, information and belief, and that Affiant expects said entity to be able to prove the same at any hearing thereof.



Signature of Affiant

Sworn and subscribed before me this 27th day of August, 2021.

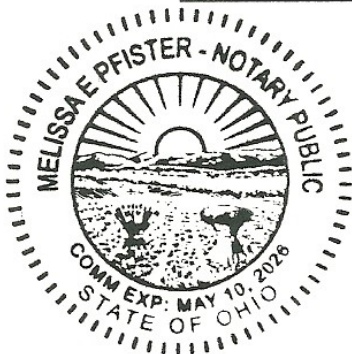

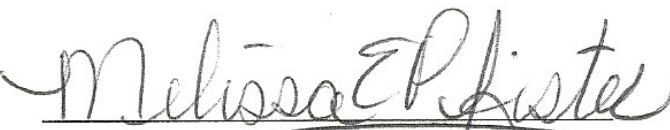

Signature of official administering oath

My Commission expires 05-10-2028.

23. § 1.36 Verification.

Verification

I, Joshua S. Motzer, hereby state that the facts above set forth are true and correct (or are true and correct to the best of my knowledge, information and belief), and that I expect to be able to prove the same at a hearing held in this matter. I understand that the statements herein are made subject to the penalties of 18 Pa. C.S. § 4904 (relating to unsworn falsification to authorities).

8/31/2021



Date

Signature

Joshua S. Motzer
Printed name

CenturyTel Broadband Services, LLC

Exhibit List

Exhibit 1 - Copy of the Applicant's Certificate of Authority from Louisiana Secretary of State, State of Incorporation.

Copy of the Applicant's Certificate of Authority from Pennsylvania Secretary of State, authorizing the applicant to do business within the State of Pennsylvania.

Exhibit 2 - List of Director and Officers

Exhibit 3 – Current list of certificated affiliates operating in other states.

Exhibit 4 - Copy of the proposed Competitive Access Services Tariff and Competitive Local Exchange Telecommunications Services Tariff

UNITED STATES OF AMERICA

State of Louisiana



Jox McKeithen

SECRETARY OF STATE

As Secretary of State, of the State of Louisiana, I do hereby Certify that

a copy of the Articles of Organization and Initial Report of

CENTURYTEL INTERNET SERVICES, LLC

Domiciled at MONROE, LOUISIANA,

Was filed and recorded in this Office on October 21, 1999,

And all fees having been paid as required by law, the limited liability company is authorized to transact business in this State, subject to the restrictions imposed by law, including the provisions of R.S. Title 12, Chapter 22.

In testimony whereof, I have hereunto set my hand and caused the Seal of my Office to be affixed at the City of Baton Rouge on,

October 21, 1999

Jox McKeithen

BBE 34852296K
Secretary of State



ORIG# 362 BNDL# 12173
8/3/2009 8:52:49 AM

Assumed Name Certificate

FILED AND RECORDED
EAST BATON ROUGE PARISH, LA
DOUG WELBORN
CLERK OF COURT AND RECORDER

State of Louisiana

Parish of East Baton Rouge

CUSTOMER PROVIDED COPY FOR
CERTIFIED TRUE COPY
BY: *Jay D. Penabile*
DEPUTY CLERK AND RECORDER

BEFORE ME, the undersigned Notary Public, duly commissioned and qualified in the
aforementioned county and state, personally came and appeared:

Kay Buchart, duly authorized representative of: CenturyTel Broadband Services, LLC

Who, after being duly sworn, did depose and say that:

The entity is operating a business under the trade name of: **CenturyLink Broadband**,
located at 100 CenturyTel Drive, Monroe, LA 71203, in the parish of Ouachita, State of Louisiana.

Kay Buchart

Signature of Appearer
Kay Buchart, Manager

SWORN TO AND SUBSCRIBED before me this 28th day of July, 2009

State of Louisiana
Parish of Ouachita

C. Inabnett

Notary Public
Carriek Inabnett
Bar No.: 21635

Commission expires Death

UNITED STATES OF AMERICA

State of Louisiana



Fox McKeithen
 SECRETARY OF STATE

As Secretary of State, of the State of Louisiana, I do hereby Certify that the annexed transcript was prepared by and in this office from the record on file, of which purports to be a copy, and that it is full, true and correct.

In testimony whereof, I have hereunto set my hand and caused the Seal of my Office to be affixed at the City of Baton Rouge on,

DEC 07 1889
Fox McKeithen

Secretary of State



UNITED STATES OF AMERICA

State of  Louisiana

Jox McKeithen
 SECRETARY OF STATE

As Secretary of State, of the State of Louisiana, I do hereby Certify that the annexed transcript was prepared by and in this office from the record on file, of which purports to be a copy, and that it is full, true and correct.

In testimony whereof, I have hereunto set my hand and caused the Seal of my Office to be affixed at the City of Baton Rouge on,

DEC 07 1899

Jox McKeithen

Secretary of State



**NOTICE OF CHANGE
TO THE INITIAL REPORT
OF**

CENTURYTEL INTERNET SERVICES, LLC

Pursuant to R.S. §1305(E)(4), the Initial Report of CenturyTel Internet Services, LLC, filed on October 21, 1999, is hereby changed as follows:

The name and address of the member is:

<u>Name</u>	<u>Address</u>
CenturyTel, Inc.	100 Century Park Drive, Monroce, LA 71203

Dated: October 29, 1999

To be signed by each person who signed the articles of organization:



 Stacy W. Goff

ASSUMED NAME CERTIFICATE (LIMITED LIABILITY COMPANY)

STATE OF LOUISIANA
PARISH OF OUACHITA

SS

BY LINDA LANDRUM
1000 P
MONROE LA 71203
MAR 17 2 19 PM '00
1279984

FILED & RECORDED
CLERK & RECORDER
OUACHITA PARISH, LA

Before me the undersigned notary public duly commissioned and qualified in the state of Louisiana, parish aforesaid, personally came and appeared STACEY W. GOFF and Kay C. Buchart, the MANAGER/VICE PRESIDENT and Manager/Secretary of **CenturyTel Internet Services, LLC**, a limited liability company organized under the laws of the State of Louisiana, and after being duly sworn, depose and say:

That they are the Manager/Vice President and Manager/Secretary of **CenturyTel Internet Services, LLC**, a limited liability company organized under the laws of the State of Louisiana and that said limited liability company is operating a business under the trade name of **CenturyTel**, at 100 Century Park Drive, Monroe, LA 71203.

CenturyTel Internet Services, LLC

By: [Signature]
Stacey W. Goff
Manager/Vice President

By: [Signature]
Kay C. Buchart
Manager/Secretary

Sworn to and subscribed before me this 8th day of March, 2000.

[Signature]
NOTARY PUBLIC

ARTICLES OF AMENDMENT
OF A LIMITED LIABILITY COMPANY

Pursuant to Louisiana R.S. 12:1309, the undersigned submits the following Articles of
Amendment:

1. The name of the limited liability company is: CenturyTel Internet Services, LLC

2. The amendment to its articles of organization is as follows:

The name of the limited liability company is CenturyTel Broadband Services, LLC

3. The date and manner of adoption of the amendment are:
By Unanimous Consent of the Manager/Directors of the LLC.

Dated at Mopre, Louisiana on the 15th day of April, 2005.

CenturyTel Internet Services, LLC

Name of Entity

By: Kay Buchart

Kay Buchart

Print Name

Manager

Title

FOX McKEITHEN
SECRETARY OF STATE
RECEIVED & FILED
DATE APR 20 2005

STATE OF Louisiana)
) SS:
COUNTY OF Ouachita)

I, Carrick Inabnett, a Notary Public, do hereby certify that on the 15th day of April, 2005, personally appeared before me Koy Buchart, and, being first duly sworn by me acknowledged that he/she signed the foregoing document in the capacity therein set forth and declared that the statements therein contained are true.

IN WITNESS WHEREOF, I have hereunto set my hand and seal the day and year before written.

By: *[Signature]*

Carrick B. Inabnett Not. No.
Notary Public 21635

My Commission expires on: Death

(Notary Seal)

ARTICLES OF AMENDMENT
OF A LIMITED LIABILITY COMPANY

Pursuant to Louisiana R.S. 12:1309, the undersigned submits the following Articles of Amendment:

1. The name of the limited liability company is: CenturyTel Internet Services, LLC

2. The amendment to its articles of organization is as follows:

The name of the limited liability company is CenturyTel Broadband Services, LLC

3. The date and manner of adoption of the amendment are:
By Unanimous Consent of the Manager/Directors of the LLC.

Dated at Monroe, Louisiana on the 15th day of April, 2005.

CenturyTel Internet Services, LLC
Name of Entity

By: Kay Buchart

Kay Buchart
Print Name

Manager
Title

STATE OF Louisiana)
) SS:
COUNTY OF Ouachita)

I, Carrick Inabnett, a Notary Public, do hereby certify that on the 15th day of April, 2005, personally appeared before me Kay Buchart, and, being first duly sworn by me acknowledged that he/she signed the foregoing document in the capacity therein set forth and declared that the statements therein contained are true.

IN WITNESS WHEREOF, I have hereunto set my hand and seal the day and year before written.

By: *[Signature]*

Carrick B. Inabnett Notary Public 21635
Notary Public

My Commission expires on: Death

(Notary Seal)

UNITED STATES OF AMERICA

State of Louisiana

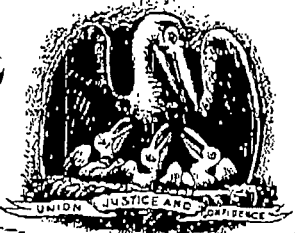

Jox McKeithen

SECRETARY OF STATE

As Secretary of State, of the State of Louisiana, I do hereby Certify that
CENTURYTEL INTERNET SERVICES, LLC

A LOUISIANA corporation domiciled at MONROE,

Filed charter and qualified to do business in this State on
October 21, 1999,

I further certify the limited liability company name was
changed from CENTURYTEL INTERNET SERVICES, LLC to CENTURYTEL
BROADBAND SERVICES, LLC.

*In testimony whereof, I have hereunto set
my hand and caused the Seal of my Office
to be affixed at the City of Baton Rouge on.*
April 19, 2005

Jox McKeithen

MBE 34852296K

Secretary of State



UNITED STATES OF AMERICA

State of Louisiana



Joy McKeithen
 SECRETARY OF STATE

As Secretary of State, of the State of Louisiana, I do hereby Certify that
 the annexed and following is a True and Correct copy of an
 Amendment as shown by comparison with document filed and
 recorded in this Office on April 20, 2005.

*In testimony whereof, I have hereunto set
 my hand and caused the Seal of my Office
 to be affixed at the City of Baton Rouge on,
 April 22, 2005*

Joy McKeithen
 ABA 34852296K

Secretary of State



Assumed Name Certificate

BY LINDA LANDRUM
 Notary Public
 State of Louisiana
 My Comm. Expires 12/31/10
 2009 JUL 29 P 12:04
 4682

State of Louisiana
 Parish of Ouachita

BEFORE ME, the undersigned Notary Public, duly commissioned and qualified in the aforementioned county and state, personally came and appeared:

Kay Buchart, duly authorized representative of: **CenturyTel Broadband Services, LLC**

Who, after being duly sworn, did depose and say that:

The entity is operating a business under the trade name of: **CenturyLink Broadband**, located at 100 CenturyTel Drive, Monroe, LA 71203, in the parish of Ouachita, State of Louisiana.

Kay Buchart
 Signature of Appearer
 Kay Buchart, Manager

SWORN TO AND SUBSCRIBED before me this 24th day of July, 2009

State of Louisiana
 Parish of Ouachita

Carrick B. Inabnett
 Notary Public
 Carrick B. Inabnett
 Doc No. : 21635

Commission Expires Death

STATE OF LOUISIANA }
 PARISH OF OUACHITA }

I hereby certify this to be a full and true copy of an original as furnished in my office on the date and hour and place the Registry Number stamped hereon to

be recorded in the {
 Conveyance } Trade
 Mortgage } Records
 Chattel Mortgage } None

Given under my hand and seal of office on said date of filing:
Linda Landrum
 DEPUTY CLERK & EX-OFFICIO RECORDER

UNITED STATES OF AMERICA

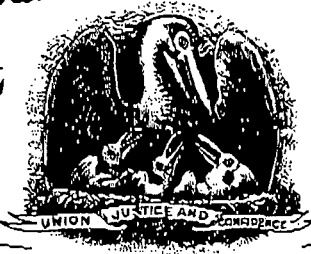

State of Louisiana

Jox McKeithen

SECRETARY OF STATE

As Secretary of State, of the State of Louisiana, I do hereby Certify that

the Articles of Organization of

CENTURYTEL INTERNET SERVICES, LLC

Domiciled at MONROE, LOUISIANA,

Were filed in this Office and a Certificate of Organization was issued on October 21, 1999,

I further certify that no Certificate of Dissolution has been issued.

In testimony whereof, I have hereunto set my hand and caused the Seal of my Office to be affixed at the City of Baton Rouge on,

March 9, 2000

Jox McKeithen

BRI 34852296K
Secretary of State

STATE OF MINNESOTA
DEPARTMENT OF STATE
FILED

MAR 14 2000

Mary Hoffmann
Secretary of State

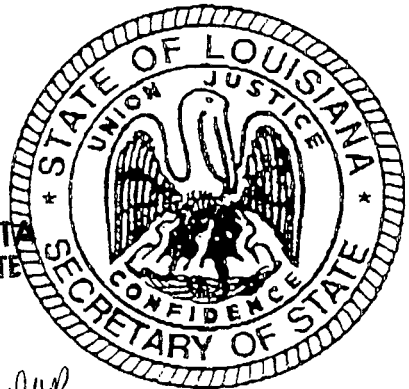

dup copy

**AMENDED AND RESTATED
ARTICLES OF ORGANIZATION
OF
CENTURYTEL INTERNET SERVICES, LLC**

On this date and by his consent, the undersigned, the sole member of CenturyTel Internet Services, LLC (the "Company"), acting pursuant to La. R.S. 12:1309, amends and restates the Articles of Organization (the "Articles") as follows:

All provisions of the existing Articles of Organization are hereby deleted and restated to read as follows:

**ARTICLE I
NAME**

The name of the limited liability company is CenturyTel Internet Services, LLC (the "Company").

**ARTICLE II
PURPOSE**

The purpose of the Company is to engage in any lawful activity for which limited liability companies may be formed under the Act.

**ARTICLE III
OPERATING AGREEMENT**

The Company shall at all times have a written operating agreement (the "Operating Agreement"). In the event of a conflict between the Articles and the Operating Agreement, the Articles shall govern.

**ARTICLE IV
MANAGEMENT BY MANAGERS**

The Company shall be managed by managers (the "Managers"), consisting of director managers elected by the members (the "Director Managers") and officer managers appointed by the Director Managers (the "Officer Managers"), as provided in the Operating Agreement. The members ("Shareholders") are not mandataries of the Company and have no authority to act on its behalf. The vote, consent or approval of the Shareholders shall not be required for: (a) the incurrence of any indebtedness by the Company (whether or not in the ordinary course of business); (b) the sale, exchange, lease or other alienation or transfer of assets, including immovable and other real property, involving less than all or substantially all of the assets of the

F:\NPG1.DOC\CLIPFILE\CenturyTel 20\AVCONTEL\44-4499\44081\Amended Article...

Company; or (c) any mortgage, plodge, or other security transaction or encumbrance, all of which may be authorized by the Director Managers, who may delegate authority to execute documents taking such actions to Officer Managers.

A person may be elected to scerve both as a Director Manager and as an Officer Manager. Director Managers may be referred to as Directors and Officer Managers may be referred to as Officers.

Any restrictions on the authority of Managers are contained in the Operating Agrcement.

**ARTICLE V
TERM**

The term of the Company shall be perpetual.

**ARTICLE VI
WITHDRAWAL**

No Shareholder can withdraw from the Company. If these Articles cannot validly prohibit withdrawal, then a Shareholder can withdraw for just cause and his Shares shall ipso facto be redeemed and converted into the right to receive distributions if and when the Company is dissolved and his distributions shall be made in accordance with the Act.

**ARTICLE VII
RELIANCE ON CERTIFICATE**

Persons dealing with the Company may rely upon a certificate of any Manager pursuant to La. R.S. 12:1317(C) to establish the membership of any Shareholder, the authenticity of any records of the Company, or the authority of any person to act on behalf of the Company, including but not limited to the authority to take the actions referred to in La. R.S. 12:1318(B).

WITNESSES:

Stacey W. Goff
Karen Patterson

Stacey W. Goff
STACEY W. GOFF, Member

ACKNOWLEDGMENT

STATE OF LOUISIANA

PARISH OF OUACHITA

BEFORE ME, the undersigned authority, personally came and appeared **STACEY W. GOFF**, to me known to be the person described in and who executed the foregoing instrument as the Member, and acknowledged that he executed such instrument as his free act and deed.

IN WITNESS WHEREOF, I have hereunto affixed my hand on this 29th day of October, 1999, in the above State and Parish.

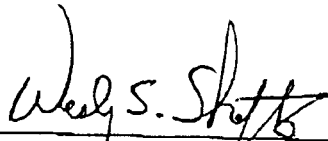

NOTARY PUBLIC

W. Fox McKeithen
Secretary of State



ARTICLES OF ORGANIZATION
(R.S. 12:1301)

Domestic Limited Liability Company
Enclose \$60.00 filing fee
Make remittance payable to:
Secretary of State
Do not send cash

Return to:
Corporations Division
P.O. Box 94125
Baton Rouge, LA 70804-9125
Phone (504) 925-4704

STATE OF LOUISIANA

PARISH OF OUACHITA

Check one: Business () Non Profit

FOX MCKEITHEN
Secretary of State
Received & Filed
DATE OCT 21 1999

1. The name of this limited liability company is: CenturyTel Internet Services, LLC

2. This company is formed for the purpose of: (check one)

Engaging in any lawful activity for which limited liability companies may be formed.

() _____
(use for limiting activity)

3. The duration of this limited liability company is: (may be perpetual) perpetual

4. Other provisions: _____

Signature: _____

STACEY W. GOFF

Sworn to and subscribed before me at Monroe, LA, this 11th
day of October, 19 99.

Notary

W. Fox McKeithen
Secretary of State



LIMITED LIABILITY COMPANY INITIAL REPORT
(R.S. 12:1305 (E))

- The name of this limited liability company is: CenturyTel Internet Services, LLC
- The location and municipal address, not a post office box only, of this limited liability company's registered office:
100 Century Park Drive, Monroe, LA 71203
- The full name and municipal address, not a post office box only, of each of this limited liability company's registered agent(s) is/are:
C T Corporation System, 8550 United Plaza Boulevard, Baton Rouge, La 70809
- The names and municipal addresses, not a post office box only, of the first managers, or the members:
Stacey W. Goff, 100 Century Park Drive, Monroe, LA 71203

To be signed by each person who signed the articles of organization.

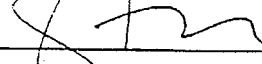

 STACEY W. GOFF

AGENT'S AFFIDAVIT AND ACKNOWLEDGEMENT OF ACCEPTANCE

I hereby acknowledge and accept the appointment of registered agent for and on behalf of the above named limited liability company.

Registered agent(s) signature(s):
C T Corporation System

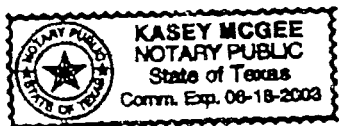

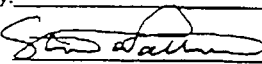
By:  Steven C. Patterson
 Special Assistant Secretary

Sworn to and subscribed before me this 21 day of October, 19 99



 Notary

EXHIBIT 1

COMMONWEALTH OF PENNSYLVANIA
DEPARTMENT OF STATE
BUREAU OF CORPORATIONS AND CHARITABLE ORGANIZATIONS
401 NORTH STREET, ROOM 206
P.O.BOX 8722
HARRISBURG, PA 17105-8722
WWW.CORPORATIONS.PA.GOV

CT Corporation System

CenturyTel Broadband Services, LLC

The Bureau of Corporations and Charitable Organizations is happy to send your filed document. The Bureau is here to serve you and we would like to thank you for doing business in Pennsylvania.

Thank you for registering with the Department of State to do business in Pennsylvania. Like many other businesses, you may have employees, sell taxable products, or provide a taxable service to consumers in Pennsylvania. Please visit www.pa100.state.pa.us to register for Business Taxes with the PA Department of Revenue & Labor and Industry or visit www.Business.pa.gov to find answers to most common registration questions.

If you have any questions pertaining to the Bureau, please visit our website at www.dos.pa.gov/BusinessCharities Or you may contact us by telephone at (717)787-1057. Information regarding business and UCC filings can be found on our searchable database at www.corporations.pa.gov/Search/CorpSearch .

Entity number : 7346061

Entity# : 7346061
Date Filed : 08/16/2021
Pennsylvania Department of State

PENNSYLVANIA DEPARTMENT OF STATE
BUREAU OF CORPORATIONS AND CHARITABLE ORGANIZATIONS

<input type="checkbox"/> Return document by mail to:		CT - COUNTER Foreign Registration Statement DSCB:15-412 (rev. 2/2017)  TCO210816DP0455	
Name <u>70981677 WS 2</u>			
Address <u>nicole.grimme@wollersklawer.com</u>			
City _____	State _____		Zip Code _____
<input checked="" type="checkbox"/> Return document by email to: _____			

Read all instructions prior to completing. This form may be su.

Fee: \$250

I qualify for a veteran/reservist-owned small business fee exemption (see instructions)

In compliance with the requirements of the applicable provisions of 15 Pa.C.S. § 412 (relating to foreign registration statement), the undersigned foreign association hereby states that:

1. The type of association is (check only one):

- | | | |
|---|--|---|
| <input type="checkbox"/> Business Corporation | <input type="checkbox"/> Limited Partnership | <input type="checkbox"/> Business Trust |
| <input type="checkbox"/> Nonprofit Corporation | <input type="checkbox"/> Limited Liability (General) Partnership | <input type="checkbox"/> Professional Association |
| <input checked="" type="checkbox"/> Limited Liability Company | <input type="checkbox"/> Limited Liability Limited Partnership | |

2. The full and proper name of the foreign association as registered in its jurisdiction of formation is:

CenturyTel Broadband Services, LLC

2A. If the name in 2 does not contain a required designator or if the name in 2 is not available for use in the Commonwealth, the alternate name under which the association is registering in this Commonwealth is:

3. The jurisdiction of formation is: Louisiana

4. The street and mailing address of the association's principal office.

100 CenturyLink Drive, Monroe, LA 71203

Number and street City State Zip

Mailing address same as above.

4A. The street and mailing address of the office, if any, required to be maintained by the law of the association's jurisdiction of formation in that jurisdiction:

3867 Plaza Tower Dr. , Baton Rouge, LA 70816-4378

Number and street City State Zip

Mailing address same as above.

2021 AUG 16 AM 9:51

PA DEPT OF STATE

DSCB:15-412 - 2

5. The (a) address of the association's proposed registered office in this Commonwealth or (b) name of its Commercial Registered Office Provider and the county of venue is:

Complete part (a) OR (b) – not both:

(a) _____
Number and street City OR State Zip County

(b) c/o: C T Corporation System Dauphin
Name of Commercial Registered Office Provider County

6. Check one of the following:

- The association may not have series.
 The association may have one or more series.

7. Effective date of registration of foreign association (check, and if appropriate complete, one of the following):

- The Foreign Registration Statement shall be effective upon filing in the Department of State.
 The Foreign Registration Statement shall be effective on: _____ at _____
Date (MM/DD/YYYY) Hour (if any)

8. To be completed by Limited Liability Companies only. Check, and if appropriate complete, one of the following:

- The association is a limited liability company which is not organized to render any of the below professional service(s).
 The association is a restricted professional limited liability company organized to render one or more of the following professional service(s): (If this box is checked, one or more of the fields below must be checked.)
 Chiropractic Dentistry Law Medicine and surgery
 Optometry Osteopathic medicine and surgery Podiatric medicine Public accounting
 Psychology Veterinary medicine

IN TESTIMONY WHEREOF, the undersigned association has caused this Foreign Registration Statement to be signed by a duly authorized representative thereof this 9 day of August, 20 21.

CenturyTel Broadband Services, LLC
Name of Association
Joan E. Randazzo
Signature
Joan Randazzo
Assistant Secretary
Title

Attachment to Pennsylvania

Purpose Clause

Interexchange Carriers (IXCs), provide long distance services, IP voice services (VoIP), SIP trunking, routed services, and other business solutions

EXHIBIT 2

CONFIDENTIAL
A/C PRIVILEGE**Lumen Technologies, Inc f/k/a CenturyLink, Inc. – Director and Officer List***Current as of July 30, 2021*- **Officers**

Name	Title	Address	Telephone #	Email
Jeffrey K. Storey	Chief Executive Officer and President	1025 Eldorado Blvd., Broomfield, CO 80021	720-888-9018	Jeff.storey@lumen.com
Stacey W. Goff	Executive Vice President, General Counsel & Secretary	100 Centurylink Dr., Monroe, LA 71201	318 388 9539 x2539	stacey.goff@lumen.com
Indraneel Dev	Executive Vice President & Chief Financial Officer	1025 Eldorado Blvd., Broomfield, CO 80021	1 720 888 1731	Neel.dev@lumen.com
Shaun C. Andrews	Executive Vice President and Chief Marketing Officers	1025 Eldorado Blvd., Broomfield, CO 80021	720 888 7796	Shaun.andrews@lumen.com
Rafael Martinez-Chapman	Senior Vice President – Treasurer	1025 Eldorado Blvd., Broomfield, CO 80021	720 888 6892	Rafael.martinez-chapman@lumen.com
Douglas A. Richards	Senior Vice President – Global Tax	1025 Eldorado Blvd., Broomfield, CO 80021	720 888 1496	Douglas.richards@lumen.com
Andrea L. Genschaw	Senior Vice President & Controller	1025 Eldorado Blvd., Broomfield, CO 80021	720 888 8289	Andrea.genschaw@lumen.com
Robert W. McCarthy	Senior Vice President, Business Development	1025 Eldorado Blvd., Broomfield, CO 80021	704 731 2833	Bob.mccarthy@lumen.com
Scott A. Trezise	Executive Vice President – Human Resources	1025 Eldorado Blvd., Broomfield, CO 80021	720 888 4040	Scott.trezise@lumen.com
Andrew Dugan	Senior Vice President & Chief Technology Officer	1025 Eldorado Blvd., Broomfield, CO 80021	720 888 2983	Andrew.dugan@lumen.com
Gary Maxwell Cox	Vice President, Deputy General Counsel & Assistant Secretary	100 Centurylink Dr., Monroe, LA 71201	318 330 6745	Max.cox@lumen.com

- **Directors**

EXHIBIT 2

**CONFIDENTIAL
A/C PRIVILEGE**

Name	Title	Address	Telephone #	Email
Jeffrey K. Storey	Director	1025 Eldorado Blvd., Broomfield, CO 80021	720-888-9018	Jeff.storey@lumen.com
W. Bruce Hanks	Director & Non-Executive Vice Chairman; Lead Independent Director	100 Centurylink Dr., Monroe, LA 71201	318 381 6876	Bruce.hanks@lumen.com
T. Michael Glenn	Non-Executive Chairman	100 Centurylink Dr., Monroe, LA 71201	318 381 6876	tmglenn@lumen.com
Quincy L. Allen	Director	100 Centurylink Dr., Monroe, LA 71201	318 381 6876	Quincy.allen@lumen.com
Martha H. Bejar	Director	100 Centurylink Dr., Monroe, LA 71201	318 381 6876	Martha.bejar@lumen.com
Peter C. Brown	Director	100 Centurylink Dr., Monroe, LA 71201	318 381 6876	Peter.brown@lumen.com
Kevin P. Chilton	Director	100 Centurylink Dr., Monroe, LA 71201	318 381 6876	Kevin.chilton@lumen.com
Steven T. Clontz	Director	100 Centurylink Dr., Monroe, LA 71201	318 381 6876	Terry.clontz@lumen.com
Hal S. Jones	Director	100 Centurylink Dr., Monroe, LA 71201	318 381 6876	Hal.jones@lumen.com
Michael J. Roberts	Director	100 Centurylink Dr., Monroe, LA 71201	318 381 6876	Mike.roberts@lumen.com
Laurie A. Siegel	Director	100 Centurylink Dr., Monroe, LA 71201	318 381 6876	Laurie.siegel@lumen.com

- Top 10% Shareholders (as of 3/31/21)

Name	Percent (%)
The Vanguard Group, Inc.	11.23%

EXHIBIT 3

ENTITY LIST (By State)
ALABAMA (No formal DBA Process w/ SOS) DBA's communicated with Commission
Broadwing Communications, LLC
CenturyLink Communications, LLC
CenturyTel Broadband Services, LLC d/b/a CenturyLink
CenturyTel of Alabama, LLC d/b/a CenturyLink
Global Crossing Telecommunications, Inc.
Gulf Telephone Company, LLC d/b/a CenturyLink
Level 3 Communications, LLC
Level 3 Telecom of Alabama, LLC
TelCove Operations, LLC
WilTel Communications, LLC
ALASKA
Broadwing Communications, LLC
CenturyLink Communications, LLC
Global Crossing Telecommunications, Inc.
Level 3 Communications, LLC
WilTel Communications, LLC
ARIZONA
Broadwing Communications, LLC
CenturyLink Communications, LLC
Qwest Broadband Services, LLC d/b/a CenturyLink (CenturyTel Broadband Services, LLC)
Global Crossing Local Services, Inc.
Global Crossing Telecommunications, Inc.
Level 3 Communications, LLC
Level 3 Telecom of Arizona, LLC
Qwest Corporation d/b/a CenturyLink QC
WilTel Communications, LLC
ARKANSAS
Broadwing Communications, LLC
CenturyLink Communications, LLC
CenturyLink of Louisiana, LLC (f/k/a CenturyTel of Northwest Louisiana, Inc. d/b/a CenturyLink)
CenturyTel of Arkansas, Inc. d/b/a CenturyLink

EXHIBIT 3

ENTITY LIST (By State)
ARKANSAS (continued)
CenturyTel of Central Arkansas, LLC d/b/a CenturyLink
CenturyTel of Missouri, LLC d/b/a CenturyLink
CenturyTel of Mountain Home, Inc. d/b/a CenturyLink
CenturyTel of Northwest Arkansas, LLC d/b/a CenturyLink
CenturyTel of Redfield, Inc. d/b/a CenturyLink
CenturyTel of South Arkansas, Inc. d/b/a CenturyLink
Global Crossing Telecommunications, Inc.
Level 3 Communications, LLC
Level 3 Telecom of Arkansas, LLC
TelCove Operations, LLC
WiiTel Communications, LLC
CALIFORNIA
Broadwing Communications, LLC
CenturyLink Communications, LLC
CenturyTel of Eastern Oregon, Inc. d/b/a CenturyLink
Global Crossing Local Services, Inc.
Global Crossing Telecommunications, Inc.
Level 3 Communications, LLC
Level 3 Telecom of California, LP
WiiTel Communications, LLC
COLORADO
Broadwing Communications, LLC
CenturyLink Communications, LLC
CenturyTel of Colorado, Inc. d/b/a CenturyLink
CenturyTel of Eagle, Inc. d/b/a CenturyLink (Also provides 8 access lines into Utah from a central office in Colorado)
CenturyTel TeleVideo, Inc. d/b/a CenturyLink
El Paso County Telephone Company d/b/a CenturyLink
Global Crossing Local Services, Inc.
Global Crossing Telecommunications, Inc.
Level 3 Communications, LLC

EXHIBIT 3

ENTITY LIST (By State)
COLORADO (continued)
Level 3 Telecom of Colorado, LP
Qwest Broadband Services, LLC d/b/a CenturyLink
Qwest Corporation d/b/a CenturyLink QC
WiTel Communications, LLC
CONNECTICUT
Broadwing Communications, LLC
CenturyLink Communications, LLC
Global Crossing Local Services, Inc.
Global Crossing Telecommunications, Inc.
Level 3 Communications, LLC
Level 3 Telecom Data Services, LLC
WiTel Communications, LLC
DELAWARE
Broadwing Communications, LLC
CenturyLink Communications, LLC
Global Crossing Telecommunications, Inc.
Level 3 Communications, LLC
Level 3 Telecom Data Services, LLC
TelCove Operations, LLC
WiTel Communications, LLC
DISTRICT OF COLUMBIA
Broadwing Communications, LLC
CenturyLink Communications, LLC
Global Crossing Local Services, Inc.
Global Crossing Telecommunications, Inc.
Level 3 Communications, LLC
Level 3 Telecom of D.C., LLC
TelCove Operations, LLC
FLORIDA
Broadwing Communications, LLC
CenturyLink Communications, LLC (former dba Embarq Communications)
CenturyTel Broadband Services, LLC d/b/a CenturyLink Broadband
Embarq Florida, Inc. d/b/a CenturyLink

EXHIBIT 3

ENTITY LIST (By State)
FLORIDA (continued)
Global Crossing Local Services, Inc.
Global Crossing Telecommunications, Inc.
Level 3 Communications, LLC
Level 3 Telecom of Florida, LP
TelCove Operations, LLC
WiiTel Communications, LLC
GEORGIA
Broadwing Communications, LLC
CenturyLink Communications, LLC
Coastal Utilities, Inc. d/b/a CenturyLink
Global Crossing Local Services, Inc.
Global Crossing Telecommunications, Inc.
Level 3 Communications, LLC
Level 3 Telecom of Georgia, LP
TelCove Operations, LLC
WiiTel Communications, LLC
HAWAII
Broadwing Communications, LLC
CenturyLink Communications, LLC
Global Crossing Telecommunications, Inc.
Level 3 Communications, LLC
Level 3 Telecom of Hawaii, LP
WiiTel Communications, LLC
IDAHO
Broadwing Communications, LLC
CenturyLink Communications, LLC
CenturyTel of the Gem State, Inc. d/b/a CenturyLink
CenturyTel of Idaho, Inc. d/b/a CenturyLink
Global Crossing Telecommunications, Inc.
Level 3 Communications, LLC
Level 3 Telecom of Idaho, LLC
Qwest Corporation d/b/a CenturyLink QC
WiiTel Communications, LLC

EXHIBIT 3

ENTITY LIST (By State)
ILLINOIS
Broadwing Communications, LLC
CenturyLink Communications, LLC
Gallatin River Communications L.L.C. d/b/a CenturyLink GRC (NOTE: Registration with IL Secy. of State and IL Commerce Commission both show periods in L.L.C. which is the correct name)
Global Crossing Local Services, Inc.
Global Crossing Telecommunications, Inc.
Level 3 Communications, LLC
Level 3 Telecom of Illinois, LLC
WiTel Communications, LLC
INDIANA
Broadwing Communications, LLC
CenturyLink Communications, LLC d/b/a Lumen
CenturyTel of Central Indiana, Inc. d/b/a CenturyLink
CenturyTel of Odon, Inc. d/b/a CenturyLink
United Telephone Company of Indiana, Inc. d/b/a CenturyLink
Global Crossing Local Services, Inc.
Global Crossing Telecommunications, Inc.
Level 3 Communications, LLC
Level 3 Telecom of Indiana, LP
WiTel Communications, LLC
IOWA
Broadwing Communications, LLC
CenturyLink Communications, LLC
CenturyTel of Chester, Inc. d/b/a CenturyLink
CenturyTel of Postville, Inc. d/b/a CenturyLink
Embarq Missouri, Inc. d/b/a CenturyLink
Global Crossing Telecommunications, Inc.
Level 3 Communications, LLC
Level 3 Telecom of Iowa, LLC
Qwest Broadband Services, LLC d/b/a CenturyLink
Qwest Corporation d/b/a CenturyLink QC
KANSAS (No formal DBA Process w/ SOS) DBA's communicated with Commission
Broadwing Communications, LLC
CenturyLink Communications, LLC

EXHIBIT 3

ENTITY LIST (By State)
KANSAS (continued)
Embarq Missouri, Inc. d/b/a CenturyLink
Global Crossing Local Services, Inc.
Global Crossing Telecommunications, Inc.
Level 3 Communications, LLC
Level 3 Telecom of Kansas City, LLC
TelCove Operations, LLC
United Telephone Company of Eastern Kansas d/b/a CenturyLink
United Telephone Company of Kansas d/b/a CenturyLink
United Telephone Company of Southcentral Kansas d/b/a CenturyLink
WiiTel Communications, LLC
KENTUCKY
Broadwing Communications, LLC
CenturyLink Communications, LLC
Global Crossing Local Services, Inc.
Global Crossing Telecommunications, Inc.
Level 3 Communications, LLC
Level 3 Telecom of Kentucky, LLC
TelCove Operations, LLC
WiiTel Communications, LLC
LOUISIANA
Broadwing Communications, LLC
CenturyLink Communications, LLC d/b/a CenturyLink Acquisition
CenturyLink Communications, LLC d/b/a CenturyLink Solutions
CenturyTel Broadband Services, LLC d/b/a CenturyLink Broadband
CenturyLink of Louisiana, LLC (ILECs consolidated into one entity in Docket # S-34211 dated 10/20/16) Effective 1/1/17
CenturyTel of South Arkansas, Inc. d/b/a CenturyLink
Global Crossing Telecommunications, Inc.
Level 3 Communications, LLC
Level 3 Telecom of Louisiana, LLC
TelCove Operations, LLC
WiiTel Communications, LLC
MAINE
Broadwing Communications, LLC
CenturyLink Communications, LLC

EXHIBIT 3

ENTITY LIST (By State)
MAINE (continued)
Global Crossing Telecommunications, Inc.
Level 3 Communications, LLC
Level 3 Telecom Data Services, LLC
WiTel Communications, LLC
MARYLAND
Broadwing Communications, LLC
CenturyLink Communications, LLC
Global Crossing Local Services, Inc.
Global Crossing Telecommunications, Inc.
Level 3 Communications, LLC
Level 3 Telecom of Maryland, LLC
TelCove Operations, LLC
WiTel Communications, LLC
MASSACHUSETTS
Broadwing Communications, LLC
CenturyLink Communications, LLC
Global Crossing Local Services, Inc.
Global Crossing Telecommunications, Inc.
Level 3 Communications, LLC
Level 3 Telecom Data Services, LLC
WiTel Communications, LLC
MICHIGAN
Broadwing Communications, LLC
CenturyLink Communications, LLC
CenturyTel Midwest – Michigan, Inc. d/b/a CenturyLink
CenturyTel of Michigan, Inc. d/b/a CenturyLink
CenturyTel of Northern Michigan, Inc. d/b/a CenturyLink
CenturyTel of Upper Michigan, Inc. d/b/a CenturyLink
Global Crossing Local Services, Inc.
Global Crossing Telecommunications, Inc.
Level 3 Communications, LLC
Level 3 Telecom Data Services, LLC
TelCove Operations, LLC
WiTel Communications, LLC

EXHIBIT 3

ENTITY LIST (By State)
MINNESOTA
Broadwing Communications, LLC
CenturyLink Communications, LLC
CenturyTel of Chester, Inc. d/b/a CenturyLink
CenturyTel of Minnesota, Inc. d/b/a CenturyLink
CenturyTel of Northwest Wisconsin, LLC d/b/a CenturyLink
Embarq Minnesota, Inc. d/b/a CenturyLink
Global Crossing Local Services, Inc.
Global Crossing Telecommunications, Inc.
Level 3 Communications, LLC
Level 3 Telecom of Minnesota, LLC
Qwest Broadband Services, LLC d/b/a CenturyLink
Qwest Corporation d/b/a CenturyLink QC
WiiTel Communications, LLC
MISSISSIPPI (No formal DBA Process w/ SOS) DBA's communicated with Commission
Broadwing Communications, LLC
CenturyLink Communications, LLC
CenturyTel Broadband Services, LLC d/b/a CenturyLink Broadband Services
CenturyTel of Adamsville, Inc. d/b/a CenturyLink
CenturyTel of North Mississippi, Inc. d/b/a CenturyLink
Global Crossing Telecommunications, Inc.
Level 3 Communications, LLC
Level 3 Telecom of Mississippi, LLC
TelCove Operations, LLC
WiiTel Communications, LLC
MISSOURI
Broadwing Communications, LLC
CenturyLink Communications, LLC
CenturyTel Broadband Services, LLC d/b/a CenturyLink Broadband
CenturyTel of Missouri, LLC d/b/a CenturyLink
CenturyTel of Northwest Arkansas, LLC d/b/a CenturyLink
Global Crossing Local Services, Inc.
Global Crossing Telecommunications, Inc.

EXHIBIT 3

ENTITY LIST (By State)
MISSOURI (continued)
Embarq Missouri, Inc. d/b/a CenturyLink
Level 3 Communications, LLC
Level 3 Telecom of Kansas City, LLC
Q Fiber, LLC
Spectra Communications Group, LLC d/b/a CenturyLink
TelCove Operations, LLC
WiiTel Communications, LLC
MONTANA
Broadwing Communications, LLC
CenturyLink Communications, LLC
CenturyTel of Montana, Inc. d/b/a CenturyLink
Global Crossing Telecommunications, Inc.
Level 3 Communications, LLC
Level 3 Telecom Data Services, LLC
Qwest Corporation d/b/a CenturyLink QC
WiiTel Communications, LLC
NEBRASKA
Broadwing Communications, LLC
CenturyLink Communications, LLC
Global Crossing Telecommunications, Inc.
Level 3 Communications, LLC
Level 3 Telecom Data Services, LLC
Q Fiber LLC
Qwest Broadband Services, LLC d/b/a CenturyLink
Qwest Corporation d/b/a CenturyLink QC
United Telephone Company of the West d/b/a CenturyLink
WiiTel Communications, LLC
NEVADA
Broadwing Communications, LLC
Central Telephone Company d/b/a CenturyLink
CenturyLink Communications, LLC
CenturyTel of the Gem State, Inc. d/b/a CenturyLink

EXHIBIT 3

ENTITY LIST (By State)
NEVADA (continued)
CenturyTel Broadband Services, LLC d/b/a CenturyLink
Global Crossing Local Services, Inc.
Global Crossing Telecommunications, Inc.
Level 3 Communications, LLC
Level 3 Telecom of Nevada, LLC
WiiTel Communications, LLC
NEW HAMPSHIRE
Broadwing Communications, LLC
CenturyLink Communications, LLC
Global Crossing Local Services, Inc.
Global Crossing Telecommunications, Inc.
Level 3 Communications, LLC
Level 3 Telecom Data Services, LLC
WiiTel Communications, LLC
NEW JERSEY
Broadwing Communications, LLC
CenturyLink Communications, LLC
Global Crossing Local Services, Inc.
Global Crossing Telecommunications, Inc.
Level 3 Communications, LLC
Level 3 Telecom of New Jersey, LP
TelCove Operations, LLC
United Telephone Company of New Jersey, Inc. d/b/a CenturyLink
WiiTel Communications, LLC
NEW MEXICO (No DBA Process)
Broadwing Communications, LLC
CenturyLink Communications, LLC
CenturyTel Broadband Services, LLC
CenturyTel of the Southwest, Inc.
Global Crossing Telecommunications, Inc.
Level 3 Communications, LLC
Level 3 Telecom of New Mexico, LLC
Qwest Corporation
WiiTel Communications, LLC

EXHIBIT 3

ENTITY LIST (By State)
NEW YORK
Broadwing Communications, LLC
CenturyLink Communications, LLC
Global Crossing Local Services, Inc.
Global Crossing Telecommunications, Inc.
Level 3 Communications, LLC
Level 3 Telecom of New York, LP
TelCove Operations, LLC
WiITel Communications, LLC
NORTH CAROLINA
Broadwing Communications, LLC
Carolina Telephone & Telegraph Company LLC d/b/a CenturyLink
Central Telephone Company d/b/a CenturyLink
CenturyLink Communications, LLC d/b/a Madison River Communications (Wake, Durham, Orange, Guilford & Alamance Counties)
CenturyTel Broadband Services, LLC d/b/a CenturyLink
Global Crossing Local Services, Inc.
Global Crossing Telecommunications, Inc.
Level 3 Communications, LLC
Level 3 Telecom of North Carolina, LP
Mebtel, Inc. d/b/a CenturyLink
TelCove Operations, LLC
WiITel Communications, LLC
NORTH DAKOTA
Broadwing Communications, LLC
CenturyLink Communications, LLC
Global Crossing Telecommunications, Inc.
Level 3 Communications, LLC
Level 3 Telecom Data Services, LLC
NORTH DAKOTA (continued)
Qwest Corporation d/b/a CenturyLink QC
WiITel Communications, LLC
OHIO
Broadwing Communications, LLC
CenturyLink Communications, LLC

EXHIBIT 3

ENTITY LIST (By State)
OHIO (continued)
CenturyTel of Ohio, Inc. d/b/a CenturyLink
Global Crossing Local Services, Inc.
Global Crossing Telecommunications, Inc.
Level 3 Communications, LLC
Level 3 Telecom of Ohio, LLC
United Telephone Company of Indiana, Inc. d/b/a CenturyLink
United Telephone Company of Ohio d/b/a CenturyLink
TelCove Operations, LLC
WiITel Communications, LLC
OKLAHOMA
Broadwing Communications, LLC
CenturyLink Communications, LLC
CenturyTel of Northwest Arkansas, LLC d/b/a CenturyLink
Global Crossing Local Services, Inc.
Global Crossing Telecommunications, Inc.
Level 3 Communications, LLC
Level 3 Telecom of Oklahoma, LLC
TelCove Operations, LLC
WiITel Communications, LLC
OREGON
Broadwing Communications, LLC
CenturyLink Communications, LLC
CenturyTel of Eastern Oregon, Inc. d/b/a CenturyLink
CenturyTel of Oregon, Inc. d/b/a CenturyLink
Global Crossing Local Services, Inc.
Global Crossing Telecommunications, Inc.
Level 3 Telecom of Oregon, LLC
Level 3 Communications, LLC
Qwest Broadband Services, LLC d/b/a CenturyLink
Qwest Corporation d/b/a CenturyLink QC
United Telephone Company of the Northwest d/b/a CenturyLink
WiITel Communications, LLC
PENNSYLVANIA
Broadwing Communications, LLC

EXHIBIT 3

ENTITY LIST (By State)
PENNSYLVANIA (continued)
CenturyLink Communications, LLC
Global Crossing Local Services, Inc.
Global Crossing Telecommunications, Inc.
Level 3 Communications, LLC
Level 3 Telecom Data Services, LLC
The United Telephone Company of Pennsylvania LLC d/b/a CenturyLink
TelCove of Pennsylvania, LLC
TelCove Operations, LLC
WiITel Communications, LLC
PUERTO RICO
CenturyLink Communications, LLC
CenturyLink Latin American Solutions, LLC
RHODE ISLAND
Broadwing Communications, LLC
CenturyLink Communications, LLC
Global Crossing Local Services, Inc.
Global Crossing Telecommunications, Inc.
Level 3 Communications, LLC
Level 3 Telecom Data Services, LLC
WiITel Communications, LLC
SOUTH CAROLINA (No formal DBA Process w/ SOS)
Broadwing Communications, LLC
CenturyLink Communications, LLC
Global Crossing Local Services, Inc.
Global Crossing Telecommunications, Inc.
Level 3 Communications, LLC
Level 3 Telecom of South Carolina, LLC
TelCove Operations, LLC
United Telephone Company of the Carolinas LLC d/b/a CenturyLink
WiITel Communications, LLC
SOUTH DAKOTA
Broadwing Communications, LLC
CenturyLink Communications, LLC
Global Crossing Telecommunications, Inc.

EXHIBIT 3

ENTITY LIST (By State)
SOUTH DAKOTA (continued)
Level 3 Communications, LLC
Level 3 Telecom Data Services, LLC
Qwest Corporation d/b/a CenturyLink QC
WiiTel Communications, LLC
TENNESSEE
Broadwing Communications, LLC
CenturyLink Communications, LLC
CenturyTel of Adamsville, Inc. d/b/a CenturyLink Adamsville
CenturyTel of Claiborne, Inc. d/b/a CenturyLink Claiborne
CenturyTel of Ooltewah-Collegedale, Inc. d/b/a CenturyLink Ooltewah-Collegedale
Global Crossing Local Services, Inc.
Global Crossing Telecommunications, Inc.
Level 3 Communications, LLC
Level 3 Telecom of Tennessee, LLC
TelCove Operations, LLC
United Telephone Southeast LLC d/b/a CenturyLink
WiiTel Communications, LLC
TEXAS
Broadwing Communications, LLC
Central Telephone Company of Texas d/b/a CenturyLink
CenturyLink Communications, LLC
CenturyLink of Louisiana LLC (f/k/a CenturyTel of Northwest Louisiana, Inc. d/b/a CenturyLink)
Preferred Communications of Texas, LLC (formerly CenturyLink Public Communications, Inc.)
CenturyTel of Lake Dallas, Inc. d/b/a CenturyLink
CenturyTel of Port Aransas, Inc. d/b/a CenturyLink
CenturyTel of San Marcos, Inc. d/b/a CenturyLink
Global Crossing Local Services, Inc.
Global Crossing Telecommunications, Inc.
Level 3 Communications, LLC
Level 3 Telecom of Texas, LLC
TelCove Operations, LLC
United Telephone Company of Texas, Inc. d/b/a CenturyLink

EXHIBIT 3

ENTITY LIST (By State)
TEXAS (continued)
WiITel Communications, LLC
UTAH
Broadwing Communications, LLC
CenturyLink Communications, LLC
Global Crossing Local Services, Inc.
Global Crossing Telecommunications, Inc.
Level 3 Communications, LLC
Level 3 Telecom of Utah, LLC
Qwest Broadband Services, LLC d/b/a CenturyLink
Qwest Corporation d/b/a CenturyLink QC
WiITel Communications, LLC
VERMONT
Broadwing Communications, LLC
CenturyLink Communications, LLC
Global Crossing Local Services, Inc.
Global Crossing Telecommunications, Inc.
Level 3 Communications, LLC
Level 3 Telecom Data Services, LLC
TelCove Operations, LLC
WiITel Communications, LLC
VIRGIN ISLANDS
Level 3 Communications St. Croix, Inc.
VIRGINIA
Broadwing Communications, LLC
Central Telephone Company of Virginia d/b/a CenturyLink
CenturyLink Communications, LLC
Global Crossing Local Services, Inc.
Global Crossing Telemangement Virginia, LLC
Level 3 Communications, LLC
Level 3 Communications of Virginia, Inc.
TelCove Operations, LLC
Level 3 Telecom of Virginia, LLC

EXHIBIT 3

ENTITY LIST (By State)
VIRGINIA (continued)
United Telephone Southeast LLC d/b/a CenturyLink
WASHINGTON
Broadwing Communications, LLC
CenturyLink Communications, LLC
CenturyTel Broadband Services, LLC d/b/a CenturyLink Broadband
CenturyTel of Cowiche, Inc. d/b/a CenturyLink
CenturyTel of Inter Island, Inc. d/b/a CenturyLink
CenturyTel of Washington, Inc. d/b/a CenturyLink
Global Crossing Local Services, Inc.
Global Crossing Telecommunications, Inc.
Level 3 Communications, LLC
Level 3 Telecom of Washington, LLC
Qwest Broadband Services, LLC d/b/a CenturyLink
Qwest Corporation d/b/a CenturyLink QC
United Telephone Company of the Northwest d/b/a CenturyLink
WillTel Communications, LLC
WEST VIRGINIA
Broadwing Communications, LLC
CenturyLink Communications, LLC
TelCove Operations, LLC
Global Crossing Telecommunications, Inc.
Level 3 Communications, LLC
Level 3 Telecom Data Services, LLC
WillTel Communications, LLC
WISCONSIN (No formal DBA Process w/ SOS) DBA's communicated with Commission
Broadwing Communications, LLC
CenturyLink Communications, LLC

EXHIBIT 3

ENTITY LIST (By State)
WISCONSIN (continued)
CenturyTel Broadband Services, LLC d/b/a CenturyLink
CenturyTel of Central Wisconsin, LLC d/b/a CenturyLink
CenturyTel of Fairwater-Brandon-Alto, LLC d/b/a CenturyLink
CenturyTel of Forestville, LLC d/b/a CenturyLink
CenturyTel of Larsen-Readfield, LLC d/b/a CenturyLink
CenturyTel of the Midwest-Kendall, LLC d/b/a CenturyLink
CenturyTel of the Midwest-Wisconsin, LLC d/b/a CenturyLink
CenturyTel of Monroe County, LLC d/b/a CenturyLink
CenturyTel of Northern Wisconsin, LLC d/b/a CenturyLink
CenturyTel of Northwest Wisconsin, LLC d/b/a CenturyLink
CenturyTel of Southern Wisconsin, LLC d/b/a CenturyLink
CenturyTel of Wisconsin, LLC d/b/a CenturyLink
Global Crossing Local Services, Inc.
Global Crossing Telecommunications, Inc.
Level 3 Communications, LLC
Level 3 Telecom of Wisconsin, LP
Qwest Corporation d/b/a CenturyLink QC
Telephone USA of Wisconsin, LLC d/b/a CenturyLink
WiiTel Communications, LLC
WYOMING
Broadwing Communications, LLC
CenturyLink Communications, LLC
CenturyTel of Wyoming, Inc. d/b/a CenturyLink
Global Crossing Telecommunications, Inc.
Level 3 Communications, LLC
Level 3 Telecom Data Services, LLC
Qwest Corporation d/b/a CenturyLink QC
United Telephone Company of the West d/b/a CenturyLink of the West
WiiTel Communications, LLC

EXHIBIT 4 - COMPETITIVE ACCESS

CenturyTel Broadband Services, Inc.

Page 1 of Supplement No. 1
to
Telephone Pa. P.U.C. Tariff No. 2

COMPETITIVE ACCESS SERVICES TARIFF

CENTURYTEL BROADBAND SERVICES, INC.
REGULATIONS AND RATES
GOVERNING THE FURNISHING OF
COMPETITIVE ACCESS SERVICES
IN PENNSYLVANIA
AS SHOWN ON TITLE PAGE 1
OF THIS TELEPHONE PA. P.U.C. TARIFF NO. 2

This Supplement No. 1 introduces Telephone Pa. P.U.C. Tariff No. 2.

EXHIBIT 4 - COMPETITIVE ACCESS

CenturyTel Broadband Services, Inc.

Page 2 of Supplement No. 1
to
Telephone Pa. P.U.C. Tariff No. 2

COMPETITIVE ACCESS SERVICES TARIFF

LIST OF CHANGES INCLUDED IN THIS SUPPLEMENT

This filing introduces Telephone Pa. P.U.C. Tariff No. 2 containing rules and regulations pertaining to Competitive Local Exchange Telecommunications Services, consisting of the following pages:

EXHIBIT 4 - COMPETITIVE ACCESS

CenturyTel Broadband Services, Inc.

Supplement No. 1 to
Telephone Pa. P.U.C. Tariff No. 2
Original Title Page 1

COMPETITIVE ACCESS SERVICES TARIFF

Applying to Switched Access

within the operating territory of

CenturyTel Broadband Services, Inc.

whether offered under that name, or the trade or brand name CenturyLink or Lumen

in the Commonwealth of

Pennsylvania

This tariff contains regulations and rates for Competitive Access
Service furnished within the Commonwealth of Pennsylvania

The Company will mirror the exchange area boundaries as stated in the tariffs of the Companies listed on Page 68 of this tariff. which include Verizon Pennsylvania LLC Telephone Pa. P.U.C. Nos. 180A, 182, 182A, 185B and 185C; Verizon North LLC Telephone Pa. P.U.C. Nos. 1, 3, 5, and 6; The United Telephone Company of Pennsylvania d/b/a CenturyLink P.U.C. No. 27; Frontier Communications Commonwealth Telephone Pa P.U.C. Nos. 23 and 24; Windstream of Pennsylvania, Inc. Pa P.U.C. No. 1; Armstrong Telephone Company – North Pa P.U.C. No. 2; Armstrong Telephone Company of Pennsylvania Pa P.U.C. No. 10; Buffalo Valley Telephone Company Pa P.U.C. No. 7; Citizens Telephone Company of Kecksburg Pa P.U.C. No. 3; Citizens Telecom Company of New York Pa P.U.C. No. 2; Conestoga Telephone & Telegraph Company Pa P.U.C. No. 10; Denver & Ephrata Telephone and Telegraph Company Pa P.U.C. No. 15; Frontier Communications of Breezewood, LLC Pa P.U.C. No. 5; Frontier Communications of Canton, LLC Pa P.U.C. No. 3; Frontier Communications of Lakewood, LLC Pa P.U.C. No. 5; Frontier Communications of Pennsylvania, LLC Pa P.U.C. No. 14; Ironton Telephone Company Pa P.U.C. No. 2; Laurel Highland Telephone Company Pa P.U.C. No. 3; The North-Eastern Pennsylvania Telephone Company Pa P.U.C. No. 9; Consolidated Communications of Pennsylvania Company Pa P.U.C. No. 1; Palmerton Telephone Company Pa P.U.C. No. 5; Pymatuning Independent Telephone Company Pa P.U.C. No. 5, Lackawaxen Telecommunications Services, Inc. Telephone – PA P.U.C. No. 2, North Penn Telephone Company Telephone – PA P.U.C. No. 2, South Canaan Telephone Company Telephone – PA P.U.C. No. 7, and TDS Telecom/Mahanoy & Mahantango Telephone Company PA P.U.C. No. 5.

The Company's tariff is in concurrence with all applicable State and Federal Laws (including, but not limited to, 52 Pa. Code, 66 Pa. C.S. and the Telecommunications Act of 1934, as amended), and with the Commission's applicable Rules and Regulations and Orders. Any provisions contained in this Tariff that are inconsistent with the foregoing mentioned will be deemed inoperative and superseded.

EXHIBIT 4 - COMPETITIVE ACCESS

CenturyTel Broadband Services, Inc.

Supplement No. 1 to
Telephone Pa. P.U.C. Tariff No. 2
Section 1
Original Page 1

COMPETITIVE ACCESS SERVICES TARIFF

1. Application and Reference

1.1 Application of Tariff

This Tariff contains regulations, terms, conditions, rates and charges applicable to the provision of Switched Access Services, hereinafter referred to collectively as service(s), provided by CenturyTel Broadband Services, Inc. , hereinafter referred to as the Company. The Company's services are furnished subject to the availability of facilities and connectivity between the Company and Customer and subject to the terms and conditions of this tariff. A Carrier Identification Code (CIC) must be obtained before customers can purchase Switched Access Service for resale.

The tariffed and regulated services offered herein by CenturyTel Broadband Services, Inc. , whether under that name or the trade or brand name CenturyLink or Lumen, are subject to the terms and conditions of this Tariff. The provision of such services by the Company as set forth in this Tariff does not constitute a joint undertaking with the customer for the furnishing of any service.

EXHIBIT 4 - COMPETITIVE ACCESS

CenturyTel Broadband Services, Inc.

Supplement No. 1 to
Telephone Pa. P.U.C. Tariff No. 2
Section 1
Original Page 2

COMPETITIVE ACCESS SERVICES TARIFF

1. Application and Reference

1.2 Table of Contents

	Page
Section 1. Application and Reference	
1.1 Application of Tariff	1
1.2 Table of Contents.....	2
1.3 Explanation of Change Symbols.....	8
1.4 Explanation of Abbreviations	9
1.5 Trade names, Trademarks and Service Marks.....	11
Section 2. General Regulations	
2.1 Undertaking of The Company	1
2.1.1 Scope	1
2.1.2 Limitations.....	2
2.1.3 Liability	3
2.1.4 Provision of Services	5
2.1.5 Installation and Termination of Services	5
2.1.6 Maintaining Services.....	5
2.1.7 Changes and Substitutions	6
2.1.8 Refusal and Discontinuance of Service	6
2.1.9 Notification of Service-Affecting Activities.....	6
2.1.10 Coordination with Respect to Network Contingencies.....	7
2.1.11 Provision and Ownership of Telephone Numbers	7
2.1.12 Special Taxes, Fees, Charges.....	7
2.2 Use.....	8
2.2.1 Interference or Impairment and Unlawful Use	8

EXHIBIT 4 - COMPETITIVE ACCESS

CenturyTel Broadband Services, Inc.

Supplement No. 1 to
Telephone Pa. P.U.C. Tariff No. 2
Section 1
Original Page 3

COMPETITIVE ACCESS SERVICES TARIFF

1. Application and Reference

1.2 Table of Contents

	Page
Section 2. General Regulations (Cont'd)	
2.3 Obligations of The Customer	9
2.3.1 Damages	9
2.3.2 Ownership of Facilities and Theft	9
2.3.3 Equipment Space and Power	9
2.3.4 Availability for Testing	10
2.3.5 Design of Customer Services	10
2.3.6 References to The Company	10
2.3.7 Claims and Demands for Damages	11
2.3.8 Coordination with Respect to Network Contingencies	11
2.3.9 Jurisdictional Report Requirements	12
2.3.10 Determination of Intrastate Charges for Mixed Interstate and Intrastate Access Service	20
2.4 Payment Arrangements and Credit Allowances	22
2.4.1 Payment of Rates, Charges and Deposits.....	22
2.4.2 Minimum Periods	29
2.4.3 Cancellation of An Order for Service	29
2.4.4 Cancellation for Cause.....	29
2.4.5 Credit Allowance for Service Interruptions	30
2.4.6 Reestablishment of Service Following Fire, Flood or Other Occurrence	32
2.4.7 Title or Ownership Rights	33
2.4.8 Ordering, Rating and Billing of Access Services Where More Than One Company Is Involved	34
2.5 Connections	39
2.5.1 General	39
2.6 Definitions	40

EXHIBIT 4 - COMPETITIVE ACCESS

CenturyTel Broadband Services, Inc.

Supplement No. 1 to
Telephone Pa. P.U.C. Tariff No. 2
Section 1
Original Page 4

COMPETITIVE ACCESS SERVICES TARIFF

1. Application and Reference

1.2 Table of Contents (Cont'd)

	Page
Section 3. Carrier Common Line Access Service	
3.1	General Description 1
3.2	Limitations 1
3.2.1	Exclusions 1
3.2.2	Access Groups..... 1
3.3	Undertaking of The Company 1
3.3.1	Provision of Service 1
3.3.2	Interstate and Intrastate Usage 1
3.4	Obligations of The Customer 2
3.4.1	Switched Access Service Requirement 2
3.4.2	Supervision 2
3.5	Determination of Usage Subject to Carrier Common Line Access Rates 2
3.5.1	Determination of Jurisdiction 2
3.5.2	Switched Access Service Provided In Conjunction With A Commercial Mobile Radio Service Provider 2
3.6	Rate Regulations 3
3.6.1	Billing of Rates 3
3.6.2	Percent Interstate Use (PIU)..... 3
3.6.3	Determination of Rates 3
3.7	Rates and Charges 3
3.7.1	Carrier Common Line..... 3

EXHIBIT 4 - COMPETITIVE ACCESS

CenturyTel Broadband Services, Inc.

Supplement No. 1 to
Telephone Pa. P.U.C. Tariff No. 2
Section 1
Original Page 5

COMPETITIVE ACCESS SERVICES TARIFF

1. Application and Reference

1.2 Table of Contents (Cont'd)

	Page
Section 4. Individual Case Basis Arrangements	
4.1 Individual Case Basis (ICB) Arrangements	1
Section 5. Ordering Options for Access Service	
5.1 General	1
5.1.1 Ordering Conditions	1
5.2 Access Order	1
5.2.1 Access Order Service Date Intervals.....	1
5.2.2 Cancellation of An Access Order.....	2
5.2.3 Minimum Period.....	3
5.2.4 Discontinuance of Service	3

EXHIBIT 4 - COMPETITIVE ACCESS

CenturyTel Broadband Services, Inc.

Supplement No. 1 to
Telephone Pa. P.U.C. Tariff No. 2
Section 1
Original Page 6

COMPETITIVE ACCESS SERVICES TARIFF

1. Application and Reference

1.2 Table of Contents (Cont'd)

	Page
Section 6. Switched Access Service	
6.1	General 1
6.1.1	Switched Access Service Arrangements And Manner of Provision 2
6.1.2	Rate Categories 3
6.1.3	Acceptance Testing 9
6.1.4	Ordering Options and Conditions 9
6.2	Provision and Description of Switched Access Service 10
6.2.1	Provision of Switched Access Service 10
6.2.2	Description of Feature Group D (FGD) 11
6.3	Common Switching Optional Features 12
6.3.1	Automatic Number Identification (ANI) 12
6.3.2	Service Class Routing 13
6.4	Transmission Specifications 13
6.5	Obligations of The Company 14
6.5.1	Network Management 14
6.5.2	Design and Traffic Routing of Switched Access Service 14
6.5.3	Provision of Service Performance Data 15
6.5.4	Trunk Group Measurement Reports 15
6.5.5	Determination of Number of End Office Transport Terminations 15
6.5.6	Design Blocking Probability 16

EXHIBIT 4 - COMPETITIVE ACCESS

CenturyTel Broadband Services, Inc.

Supplement No. 1 to
Telephone Pa. P.U.C. Tariff No. 2
Section 1
Original Page 7

COMPETITIVE ACCESS SERVICES TARIFF

1. Application and Reference

1.2 Table of Contents

	Page
Section 6. Switched Access Service (Cont'd)	
6.6	Obligations of The Customer 17
6.6.1	Ordering Requirements..... 17
6.6.2	Report Requirements 17
6.6.3	Trunk Group Measurement Reports 18
6.6.4	Design of Switched Access Services..... 18
6.7	Rate Terms and Conditions 18
6.7.1	Description and Application of Rates and Charges 18
6.7.2	Minimum Periods 24
6.7.3	Minimum Monthly Charge 24
6.7.4	Moves..... 25
6.7.5	Measuring Access Minutes 25
6.7.6	Feature Group D Usage Measurement 26
6.7.7	Mileage Measurement 27
6.8	Rates and Charges 28
6.8.1	Switched Recurring Rates 28
6.8.2	Nonrecurring Rates..... 31

EXHIBIT 4 - COMPETITIVE ACCESS

CenturyTel Broadband Services, Inc.

Telephone Pa. P.U.C. Tariff No. 2

Section 1

Original Page 8

COMPETITIVE ACCESS SERVICES TARIFF

1. Application and Reference

1.3 Explanation of Change Symbols

The following symbols will be used to for the purposes indicated below:

Symbol	Explanation
(C)	To signify changed regulation
(D)	To signify decreased rate
(I)	To signify increased rate

EXHIBIT 4 - COMPETITIVE ACCESS

CenturyTel Broadband Services, Inc.

Supplement No. 1 to
Telephone Pa. P.U.C. Tariff No. 2
Section 1
Original Page 9

COMPETITIVE ACCESS SERVICES TARIFF

1. Application and Reference

1.4 Explanation of Abbreviations

ANI	-	Automatic Number Identification
AT	-	Access Tandem
ATTP	-	Access Tandem Trunk Port
BP	-	Billing Percentage
CCS	-	One hundred call seconds
CFA	-	Circuit Facility Assignment
CIC	-	Carrier Identification Code
CL	-	Common Line
CMRS	-	Commercial Mobile Radio Service
CN	-	Charge Number
Cont'd	-	Continued
CPN	-	Calling Party Number
CTBS	-	CenturyTel Broadband Services, Inc.
DTT	-	Direct-Trunked Transport
EAS	-	Extended Area Service
EF	-	Entrance Facility
e.g.	-	For example
EO	-	End Office
EOSP	-	End Office Shared Port
etc.	-	Etcetera
EU	-	End User
EXM	-	Exit Message
f	-	Frequency
F.C.C.	-	Federal Communications Commission
f/k/a	-	Formerly Known As
H	-	Horizontal
IC	-	Interexchange Carrier
ICB	-	Individual Case Basis
i.e.	-	That is

EXHIBIT 4 - COMPETITIVE ACCESS

CenturyTel Broadband Services, Inc.

Supplement No. 1 to
Telephone Pa. P.U.C. Tariff No. 2
Section 1
Original Page 10

COMPETITIVE ACCESS SERVICES TARIFF

1. Application and Reference

1.4 Explanation of Abbreviations (Cont'd)

LATA	-	Local Access and Transport Area
LEC	-	Local Exchange Carrier
LS	-	Local Switching
Mbps	-	Megabits per second
MOU	-	Minutes of Use
MRC	-	Monthly Recurring Charge
MUX	-	Multiplexing
NA	-	Not Applicable
NANP	-	North American Numbering Plan
No.	-	Number
NPA	-	Numbering Plan Area
NRC	-	Nonrecurring Charge
NXX	-	Three-Digit Central Office Code
PIU	-	Percent Interstate Use
POT	-	Point of Termination
PSTN	-	Public Switched Telephone Network
SS7	-	Signaling System 7
SWC	-	Serving Wire Center
TIM	-	Tariff Information Management
TST	-	Tandem-Switched Transport
TT	-	Tandem Transmission
V	-	Vertical
VG	-	Voice Grade
V & H	-	Vertical & Horizontal
VoIP	-	Voice over Internet Protocol

EXHIBIT 4 - COMPETITIVE ACCESS

CenturyTel Broadband Services, Inc.

Supplement No. 1 to
Telephone Pa. P.U.C. Tariff No. 2
Section 1
Original Page 11

COMPETITIVE ACCESS SERVICES TARIFF

1. Application and Reference

1.5 Trade Names, Trademarks and Service Marks

The following list of service marks, trademarks and/or trade names, which may be used for services offered herein are owned by Lumen Technologies, Inc. or a subsidiary of Lumen Technologies, Inc. and are used by CenturyTel Broadband Services, Inc. with express permission. Service mark and trademark designations will not be listed hereafter in this Competitive Access Services Tariff. However, the laws regarding service marks and trademarks are applicable. Service marks, trademarks, and trade names that are owned by Lumen Technologies, Inc. or a subsidiary of Lumen Technologies, Inc. cannot be used by another party without authorization.

Service Mark/Trademark:

CenturyLink®

Lumen®

Lumen Technologies®

Trade Name:

CenturyLink

Lumen

EXHIBIT 4 - COMPETITIVE ACCESS

CenturyTel Broadband Services, Inc.

Supplement No. 1 to
Telephone Pa. P.U.C. Tariff No. 2
Section 2
Original Page 1

COMPETITIVE ACCESS SERVICES TARIFF

2. General Regulations

2.1 Undertaking of The Company

2.1.1 Scope

- A. The Company does not undertake to transmit messages under this Tariff.
- B. The Company shall be responsible only for the installation, operation and maintenance of the services which it provides.
- C. The Company will, for maintenance purposes, test its services only to the extent necessary to detect and/or clear troubles.
- D. Services are provided 24 hours daily, seven days per week, except as set forth in other applicable sections of this Tariff.
- E. The Company does not warrant that its facilities and services meet standards other than those set forth in this Tariff and associated Technical Publications.

EXHIBIT 4 - COMPETITIVE ACCESS

CenturyTel Broadband Services, Inc.

Supplement No. 1 to
Telephone Pa. P.U.C. Tariff No. 2
Section 2
Original Page 2

COMPETITIVE ACCESS SERVICES TARIFF

2. General Regulations

2.1 Undertaking of The Company (Cont'd)

2.1.2 Limitations

- A. The customer may not assign or transfer the use of services provided under this Tariff; however, where there is no interruption of use or relocation of the services, such assignment or transfer may be made to:
 - 1. Another customer, whether an individual, partnership, association or corporation, provided the assignee or transferee assumes all outstanding indebtedness for such services, and the unexpired portion of the minimum period and the termination liability applicable to such services, if any; or
 - 2. A court-appointed receiver, trustee or other person acting pursuant to law in bankruptcy, receivership, reorganization, insolvency, liquidation or other similar proceedings, provided the assignee or transferee assumes the unexpired portion of the minimum period and the termination liability applicable to such services, if any.
- B. In all cases of assignment or transfer, the written acknowledgment of the Company is required prior to such assignment or transfer which acknowledgment shall be made within 15 days from the receipt of notification. All regulations and conditions contained in this Tariff shall apply to such assignee or transferee.
- C. The assignment or transfer of services does not relieve or discharge the assignor or transferor from remaining jointly or severally liable with the assignee or transferee for any obligations existing at the time of the assignment or transfer.
- D. The assignor or transferor and the assignee or transferee will be required to sign a Transfer of Use Agreement assuming all outstanding indebtedness as set forth in A.1., preceding. In all cases where there is no interruption of use or relocation of the services (i.e., change in Carrier Identification Code (CIC) or any other technical and/or physical change to the service), administrative changes will be made without charge(s).

EXHIBIT 4 - COMPETITIVE ACCESS

CenturyTel Broadband Services, Inc.

Supplement No. 1 to
Telephone Pa. P.U.C. Tariff No. 2
Section 2
Original Page 3

COMPETITIVE ACCESS SERVICES TARIFF

2. General Regulations

2.1 Undertaking of The Company (Cont'd)

2.1.3 Liability

- A. The Company's liability, if any, for its willful misconduct is not limited by this Tariff. with respect to any other claim or suit, by a customer or by any others, for damages associated with the installation, provision, preemption, termination, maintenance, repair or restoration of service, and subject to the provisions of B. through G., following, the Company's liability, if any, shall not exceed an amount equal to the proportionate charge for the service for the period during which the service was affected. This liability for damages shall be in addition to any amounts that may otherwise be due the customer under this Tariff as a Credit Allowance for a Service Interruption.
- B. The Company shall not be liable for any act or omission of any customer providing a portion of a service, nor shall the Company for its own act or omission hold liable any customer providing a portion of a service.
- C. The Company is not liable for damages to the customer premises resulting from the furnishing of a service, including the installation and removal of equipment and associated wiring, unless the damage is caused by the Company's negligence.
- D. The Company shall be indemnified, defended and held harmless by the customer against any claim, loss or damage arising from the customer's use of services offered under this Tariff, involving:
 1. Claims for libel, slander, invasion of privacy, or infringement of copyright arising from the customer's own communications;
 2. Claims for patent infringement arising from the customer's acts combining or using the service furnished by the Company in connection with facilities or equipment furnished by the customer or;
 3. All other claims arising out of any act or omission of the customer in the course of using services provided pursuant to this Tariff.
 4. Entering any Company-owned facility housing (e.g., above ground cabinets, underground utility vaults, utility hole, hand hole, etc.) for any purpose.

EXHIBIT 4 - COMPETITIVE ACCESS

CenturyTel Broadband Services, Inc.

Supplement No. 1 to
Telephone Pa. P.U.C. Tariff No. 2
Section 2
Original Page 4

COMPETITIVE ACCESS SERVICES TARIFF

2. General Regulations

2.1 Undertaking of The Company
2.1.3 Liability (Cont'd)

- E. The Company does not guarantee or make any warranty with respect to its services when used in an explosive atmosphere. The Company shall be indemnified, defended and held harmless by the customer from any and all claims by any person relating to such customer's use of services so provided.
- F. No license under patents (other than the limited license to use) is granted by the Company or shall be implied or arise by estoppel, with respect to any service offered under this Tariff. The Company will defend the customer against claims of patent infringement arising solely from the use by the customer of services offered under this Tariff and will indemnify such customer for any damages awarded based solely on such claims.
- G. The Company's failure to provide or maintain services under this Tariff shall be excused by labor difficulties, governmental orders, civil commotions, criminal actions taken against the Company, acts of God and other circumstances beyond the Company's reasonable control, subject to the Credit Allowance for Service Interruptions as set forth in 2.4.5, following.

EXHIBIT 4 - COMPETITIVE ACCESS

CenturyTel Broadband Services, Inc.

Supplement No. 1 to
Telephone Pa. P.U.C. Tariff No. 2
Section 2
Original Page 5

COMPETITIVE ACCESS SERVICES TARIFF

2. General Regulations

2.1 Undertaking of The Company (Cont'd)

2.1.4 Provision of Services

The Company, to the extent that such services are or can be made available with reasonable effort, and after provision has been made for the Company's telephone exchange services, will provide to the customer upon reasonable notice services offered in other applicable sections of this Tariff at rates and charges specified therein.

2.1.5 Installation and Termination of Services

The services offered under this Tariff (a) will include the provision of any entrance cable or drop wiring to a location suitable for the termination of the Company's outside distribution network facilities at the customer-designated premises and (b) will be installed by the Company to such Point of Termination (POT). Access Service has only one POT per customer premises. Any additional terminations beyond such POT are the sole responsibility of the customer.

2.1.6 Maintaining Services

The services provided under this Tariff shall be maintained by the Company. The customer or others may not rearrange, move, disconnect, remove or attempt to repair any facilities provided by the Company or contained in a Company-owned facility housing (e.g., above ground cabinets, underground utility vaults, utility hole, hand hole, etc.), except with prior written consent and presence of a Company-designated inspector.

EXHIBIT 4 - COMPETITIVE ACCESS

CenturyTel Broadband Services, Inc.

Supplement No. 1 to
Telephone Pa. P.U.C. Tariff No. 2
Section 2
Original Page 6

COMPETITIVE ACCESS SERVICES TARIFF

2. General Regulations

2.1 Undertaking of The Company (Cont'd)

2.1.7 Changes and Substitutions

- A. Except as provided for equipment and systems subject to F.C.C.'s Part 68 Regulations at 47 C.F.R. Section 68.110(b), the Company may, where such action is reasonably required in the operation of its business, (A) substitute, change or rearrange any facilities used in providing service under this Tariff, including but not limited to, (1) substitution of different metallic facilities, (2) substitution of carrier or derived facilities for metallic facilities used to provide other than metallic facilities and (3) substitution of metallic facilities for carrier or derived facilities used to provide other than metallic facilities, (B) change minimum protection criteria, change operating or maintenance characteristics of facilities or change operations or procedures of the Company.

- B. In case of any such substitution, change or rearrangement, the transmission parameters will be within the range as set forth in this Tariff and associated Technical Publications. The Company shall not be responsible if any such substitution, change or rearrangement renders any customer furnished services obsolete or requires modification or alteration thereof or otherwise affects their use or performance. If such substitution, change or rearrangement materially affects the operating characteristics of the facility, the Company will provide reasonable notification to the customer. Reasonable time will be allowed for any redesign and implementation required by the change in operating characteristics. The Company will work cooperatively with the customer to determine the reasonable notification requirements.

2.1.8 Refusal and Discontinuance of Service

Provisions for the refusal and discontinuance of service are set forth in 2.4.4, following.

2.1.9 Notification of Service-Affecting Activities

The Company will provide the customer reasonable notification of service-affecting activities that may occur in normal operation of its business. Such activities may include, but are not limited to, equipment or facilities additions, removals or rearrangements, routine preventative maintenance and major switching machine change-out. Generally, such activities are not individual customer service specific, they affect many customer services. No specific advance notification period is applicable to all service activities. The Company will work cooperatively with the customer to determine the reasonable notification requirements.

EXHIBIT 4 - COMPETITIVE ACCESS

CenturyTel Broadband Services, Inc.

Supplement No. 1 to
Telephone Pa. P.U.C. Tariff No. 2
Section 2
Original Page 7

COMPETITIVE ACCESS SERVICES TARIFF

2. General Regulations

2.1 Undertaking of The Company (Cont'd)

2.1.10 Coordination with Respect to Network Contingencies

The Company intends to work cooperatively with the customer to develop network contingency plans in order to maintain maximum network capability following natural or man-made disasters which affect telecommunications services.

2.1.11 Provision and Ownership of Telephone Numbers

The Company reserves the reasonable right to assign, designate or change telephone numbers, any other call number designations associated with Access Services, or the Company serving central office prefixes associated with such numbers, when necessary in the conduct of its business. Should it become necessary to make a change in such number(s), the Company will furnish to the customer reasonable notice of the effective date and an explanation of the reason(s) and extent for such change(s).

2.1.12 Special Taxes, Fees, Charges

Insofar as practicable, any sales, use, privilege, excise, franchise or occupation tax, costs of furnishing service without charge or similar taxes or impositions now or hereafter levied by the Federal, State, or Local government or any political subdivision or taxing authority thereof may be billed by the Company to its customers on a pro rata basis in the areas wherein such taxes, impositions or other charges shall be levied against the Company.

EXHIBIT 4 - COMPETITIVE ACCESS

CenturyTel Broadband Services, Inc.

Supplement No. 1 to
Telephone Pa. P.U.C. Tariff No. 2
Section 2
Original Page 8

COMPETITIVE ACCESS SERVICES TARIFF

2. General Regulations

2.2 Use

2.2.1 Interference or Impairment and Unlawful Use

- A. The characteristics and methods of operation of any circuits, facilities or equipment provided by other than the Company and associated with the facilities utilized to provide services under this Tariff shall not interfere with or impair service over any facilities of the Company, its affiliated companies, or its connecting and concurring carriers involved in its services, cause damage to their plant, impair the privacy of any communications carried over their facilities or create hazards to the employees of any of them or the public.
- B. Except as provided for equipment or systems subject to the F.C.C.'s Part 68 Rules in 47 C.F.R. Section 68.108, if such characteristics or methods of operation are not in accordance with A., preceding, the Company will, where practicable, notify the customer that temporary discontinuance of the use of a service may be required; however, where prior notice is not practicable, nothing contained herein shall be deemed to preclude the Company's right to temporarily discontinue forthwith the use of a service if such action is reasonable under the circumstances. In case of such temporary discontinuance, the customer will be promptly notified and afforded the opportunity to correct the condition which gave rise to the temporary discontinuance. During such period of temporary discontinuance, Credit Allowance for Service Interruptions as set forth in 2.4.5, following, is not applicable.
- C. The services provided under this Tariff shall not be used for any unlawful purpose.

EXHIBIT 4 - COMPETITIVE ACCESS

CenturyTel Broadband Services, Inc.

Supplement No. 1 to
Telephone Pa. P.U.C. Tariff No. 2
Section 2
Original Page 9

COMPETITIVE ACCESS SERVICES TARIFF

2. General Regulations

2.3 Obligations of The Customer

2.3.1 Damages

The customer shall reimburse the Company for damages to Company facilities for all services utilized to provide services under this Tariff caused by the negligence or willful act of the customer or resulting from the customer's improper use of the Company facilities, or due to malfunction of any facilities or equipment provided by other than the Company. Nothing in the foregoing provision shall be interpreted to hold one customer liable for another customer's actions. The Company will, upon reimbursement for damages, cooperate with the customer in prosecuting a claim against the person causing such damage and the customer shall be subrogated to the right of recovery by the Company for the damages to the extent of such payment.

2.3.2 Ownership of Facilities and Theft

Facilities utilized by the Company to provide service under the provisions of this Tariff shall remain the property of the Company. Such facilities shall be returned to the Company by the customer, whenever requested, within a reasonable period following the request in as good condition as reasonable wear will permit.

2.3.3 Equipment Space and Power

The customer shall furnish or arrange to have furnished to the Company, at no charge, equipment space and electrical power required by the Company to provide services under this Tariff at the POT of such services. The selection of ac or dc power shall be mutually agreed to by the customer and the Company. The customer shall also make necessary arrangements in order that the Company will have access to such spaces at reasonable times for installing, testing, inspecting, repairing or removing Company services.

EXHIBIT 4 - COMPETITIVE ACCESS

CenturyTel Broadband Services, Inc.

Supplement No. 1 to
Telephone Pa. P.U.C. Tariff No. 2
Section 2
Original Page 10

COMPETITIVE ACCESS SERVICES TARIFF

2. General Regulations

2.3 Obligations of The Customer (Cont'd)

2.3.4 Availability for Testing

The services provided under this Tariff shall be available to the Company at times mutually agreed upon in order to permit the Company to make tests and adjustments appropriate for maintaining the services in satisfactory operating condition. Such tests and adjustments shall be completed within a reasonable time. No credit will be allowed for any interruptions involved during such tests and adjustments.

2.3.5 Design of Customer Services

Subject to the provisions of 2.1.7, preceding, the customer shall be solely responsible, at its own expense, for the overall design of its services and for any redesigning or rearrangement of its services which may be required because of changes in facilities, operations or procedures of the Company, minimum protection criteria or operating or maintenance characteristics of the facilities.

2.3.6 References to The Company

The customer may advise end users that certain services are provided by the Company in connection with the service the customer furnishes to end users; however, the customer shall not represent that the Company jointly participates in the customer's services.

EXHIBIT 4 - COMPETITIVE ACCESS

CenturyTel Broadband Services, Inc.

Supplement No. 1 to
Telephone Pa. P.U.C. Tariff No. 2
Section 2
Original Page 11

COMPETITIVE ACCESS SERVICES TARIFF

2. General Regulations

2.3 Obligations of The Customer (Cont'd)

2.3.7 Claims and Demands for Damages

- A. With respect to claims of patent infringement made by third persons, the customer shall defend, indemnify, protect and save harmless the Company from and against all claims arising out of the combining with, or use in connection with, the services provided under this Tariff, any circuit, apparatus, system or method provided by the customer.
- B. The customer shall defend, indemnify and save harmless the Company from and against any suits, claims, losses or damages by third persons arising out of the construction, installation, operation, maintenance, or removal of the customer's circuits, facilities, or equipment connected to the Company's services provided under this Tariff. Included, without limitation, are Workmen's Compensation claims, actions for infringement of copyright and/or unauthorized use of program material. Also included without limitation are libel and slander actions based on the content of communications transmitted over the customer's circuits, facilities or equipment. In addition, proceedings to recover taxes, fines, or penalties for failure of the customer to obtain or maintain in effect any necessary certificates, permits, licenses, or other authority to acquire or operate the services provided under this Tariff shall be included in the indemnification. However, the foregoing indemnification shall not apply to suits, claims, and demands to recover damages for damage to property, death, or personal injury unless such suits, claims or demands are based on the tortuous conduct of the customer, its officers, agents or employees.
- C. The customer shall defend, indemnify and save harmless the Company from and against any suits, claims, losses or damages, by the customer or third parties arising out of any act or omission of the customer in the course of using services provided under this Tariff.

2.3.8 Coordination with Respect to Network Contingencies

The customer shall, in cooperation with the Company, coordinate in planning the actions to be taken to maintain maximum network capability following natural or man-made disasters which affect telecommunications services.

EXHIBIT 4 - COMPETITIVE ACCESS

CenturyTel Broadband Services, Inc.

Supplement No. 1 to
Telephone Pa. P.U.C. Tariff No. 2
Section 2
Original Page 12

COMPETITIVE ACCESS SERVICES TARIFF

2. General Regulations

2.3 Obligations of The Customer (Cont'd)

2.3.9 Jurisdictional Report Requirements

A. Jurisdictional Determinant

Pursuant to Federal Communications Commission order F.C.C. 85-145 adopted April 16, 1985, interstate usage is to be developed as though every call that enters a customer network at a point within the same state as that in which the called station (as designated by the called station number) is situated is an intrastate communication and every call for which the point of entry is in a state other than that where the called station (as designated by the called station number) is situated is an interstate communication.

To determine the jurisdiction of a call, the Company compares the originating number information with the terminating number information. Traffic without sufficient call detail shall be that traffic for which the originating number information lacks a valid Charge Party Number or Calling Party Number.

When mixed interstate and intrastate Access Service is provided on the same Access Service transmission path, all charges between interstate and intrastate are prorated as set forth in 2.3.10, following.

EXHIBIT 4 - COMPETITIVE ACCESS

CenturyTel Broadband Services, Inc.

Supplement No. 1 to
Telephone Pa. P.U.C. Tariff No. 2
Section 2
Original Page 13

COMPETITIVE ACCESS SERVICES TARIFF

2. General Regulations

2.3 Obligations of The Customer

2.3.9 Jurisdictional Report Requirements (Cont'd)

B. Jurisdictional Requirements

The customer must indicate a projected Percent of Interstate Use (PIU) factor in a whole number (i.e., a number 0 - 100) when ordering Switched Access Service in a State including EF and DTT Facilities.

1. Feature Group D (FGD) - Originating Service

When a customer orders FGD Switched Access Service, where the jurisdiction is determined from the call detail, the Company will develop the projected PIU factor according to such jurisdiction. The projected interstate percentage is developed on a monthly basis, by end office, when the originating FGD access minutes are measured, by dividing the measured interstate originating access minutes by the total originating access minutes.

2. Feature Group D (FGD) - Terminating Service

When a customer orders terminating FGD, if the Company has sufficient call details to determine the jurisdiction for the call, the Company will bill the call minutes of use according to that jurisdiction.

When terminating call details are insufficient to determine the jurisdiction for the call, the customer may supply the projected PIU factor by State (when the customer reports a State-level PIU factor, the specified percentage applies to all end offices within the State.) The projected PIU factor will be used to apportion the terminating call minutes for which call details were insufficient to determine jurisdiction between the interstate and intrastate jurisdictions.

When terminating call details are insufficient to determine the jurisdiction, and the customer does not supply a projected PIU factor by State, calls will be billed using a PIU of 50 (50% interstate – 50% intrastate).

EXHIBIT 4 - COMPETITIVE ACCESS

CenturyTel Broadband Services, Inc.

Supplement No. 1 to
Telephone Pa. P.U.C. Tariff No. 2
Section 2
Original Page 14

COMPETITIVE ACCESS SERVICES TARIFF

2. General Regulations

2.3 Obligations of The Customer

2.3.9 Jurisdictional Report Requirements (Cont'd)

C. Jurisdictional Reports

1. Percent Interstate Use (PIU) Factor

Except where Company measured access minutes are used as set forth in B., preceding, the customer-provided PIU factor will be used until the customer reports a different projected PIU factor based on the following guidelines.

- a. The customer may update the PIU factor via jurisdictional report on a quarterly basis. The customer shall report the PIU factor by traffic and service type by State. The customer shall forward to the Company a revised report, to be received no later than fourteen (14) days after the first of January, April, July and October. The revised report shall show the PIU factor for the most current data available, for each service arranged for interstate use. This data shall consist of at least three (3) and no more than twelve (12) consecutive months' of data, ending no more than seventy-five (75) days earlier than the date the report is due (e.g., for the report due January 15th, the last month of data should be no earlier than October 31st). The updated PIU factor shall be based on call detail records. The PIU factor can be based on a statistically valid sample. The PIU factor reported in January, April, July and October will be effective on the bill date of each such month and will serve as the basis for subsequent monthly billing pending the receipt of a revised PIU report.
- b. No prorating or back billing will be done based on the jurisdictional report. However, usage will be billed utilizing the interstate percentage that was in effect at the time the usage was generated.
- c. The customer shall maintain and retain the work papers that show how the interstate percentage was determined and a summary derived from the actual call detail records for a minimum twelve (12) month period which statistically substantiates each interstate percentage provided to the Company. This summary at a minimum shall include month, year, state, traffic type (e.g., originating, terminating, 8XX, etc.) and service type. The Company may request the work papers and summary in support of the customer's projected PIU factor.

EXHIBIT 4 - COMPETITIVE ACCESS

CenturyTel Broadband Services, Inc.

Supplement No. 1 to
Telephone Pa. P.U.C. Tariff No. 2
Section 2
Original Page 15

COMPETITIVE ACCESS SERVICES TARIFF

2. General Regulations

2.3 Obligations of The Customer

2.3.9 Jurisdictional Report Requirements

C.1. (Cont'd)

- d. The Company may request the actual call detail records or a statistically valid sample of such records, on a prospective basis, not to exceed a consecutive three-month period. The actual call detail records will be used to statistically substantiate the interstate percentage provided to the Company and the process by which it is developed. Such call detail records shall consist of call information, including call terminating address (i.e., called number), call duration, the trunk group number(s), or access line number(s) over which the call is routed and the point at which the call enters the customer's network. The Company will not request such data more than once a year.
- e. If quarterly reports are not supplied by the customer, the following steps will be taken by the Company:
 - (1) If the customer does not supply the reports, the Company will assume the PIU factors to be the same as those provided in the last quarterly report. For those cases in which a quarterly report has never been received from the customer, the Company will assume the PIU factors to be the same as those provided in the order for service as set forth in B., preceding. In any case, the Company reserves the right to request actual call detail supporting the customer's reported PIU, as specified preceding.
 - (2) If a quarterly report has never been received from the customer, and the customer failed to report a PIU in the order for service, the Company will designate a fifty percent (50%) interstate percentage beginning with the next billing period. This interstate percentage will be applied until a quarterly PIU report is submitted.

EXHIBIT 4 - COMPETITIVE ACCESS

CenturyTel Broadband Services, Inc.

Supplement No. 1 to
Telephone Pa. P.U.C. Tariff No. 2
Section 2
Original Page 16

COMPETITIVE ACCESS SERVICES TARIFF

2. General Regulations

2.3 Obligations of The Customer

2.3.9 Jurisdictional Report Requirements (Cont'd)

D. Jurisdictional Report Dispute and Auditing Procedures

If a billing dispute arises concerning the projected interstate percentage, the Company will ask the customer to provide the data the customer uses to determine the projected interstate percentage as described in 1., following.

1. Switched Access Services

- a. If the Company questions the information provided by the customer in C., preceding, the Company will send a letter to the customer (by certified U.S. Mail, return receipt requested) requesting that the customer contact the Company to discuss and explain their report within thirty (30) days of the Company's request.
- b. If no response is received from the customer, the Company will send a letter to the customer (by certified U.S. Mail, return receipt requested) requesting the work papers and summary as described in C., preceding, used by the customer to substantiate the most recent interstate percentage. The requested information must be submitted by the customer to the Company within thirty (30) days after receipt of the certified letter.
- c. If the customer submits the work papers and summary as requested in b., preceding, the Company will review this information within thirty (30) days after receipt of the customer's information.
- d. If after review of the documentation, the Company and the customer establish a revised interstate percentage, the Company will begin using that percentage with the next billing period.

EXHIBIT 4 - COMPETITIVE ACCESS

CenturyTel Broadband Services, Inc.

Supplement No. 1 to
Telephone Pa. P.U.C. Tariff No. 2
Section 2
Original Page 17

COMPETITIVE ACCESS SERVICES TARIFF

2. General Regulations

2.3 Obligations of The Customer

2.3.9 Jurisdictional Report Requirements

D.1. (Cont'd)

- e. If the Company and the customer do not establish a revised interstate percentage, the Company will begin the procedures as set forth in g., following.
- f. If no response is received from the customer, the Company will begin the auditing procedures as set forth in g., following, and notify the Commission.
- g. When jurisdictional reports are not provided by the customer or a billing dispute arises, the Company may request an audit. The audit procedures and responsible party(ies) for payment of audit expenses will be determined as follows:
 - If the Company and the customer mutually agree upon an independent auditing firm and the party(ies) agree to equally share in the payment of audit expenses, both the Company and the customer will be bound by such agreement; or
 - The customer may select an independent auditing firm and pay all audit expenses.
 - If the audit is not conducted as set forth preceding, the Company may select an independent auditing firm and pay all expenses.
- h. The Company will adjust the customer's PIU based upon the audit results. The PIU resulting from the audit shall be applied to the usage for the quarter the audit is completed, the usage for the quarter prior to completion of the audit and the usage for the two (2) quarters following the completion of the audit. After that time, the customer may report a revised PIU pursuant to C., preceding. The Company will implement the revised interstate percentage to the next billing period or quarterly report date, whichever is first.

2. Jurisdictional Report Proprietary Information

The data the customer provides to the Company to support their interstate percentage is considered proprietary to the customer. The Company agrees to use and protect such information by exercising the same degree of care normally used to protect its own proprietary information.

EXHIBIT 4 - COMPETITIVE ACCESS

CenturyTel Broadband Services, Inc.

Supplement No. 1 to
Telephone Pa. P.U.C. Tariff No. 2
Section 2
Original Page 18

COMPETITIVE ACCESS SERVICES TARIFF

2. General Regulations

2.3 Obligations of The Customer

2.3.9 Jurisdictional Report Requirements

D. Jurisdictional Report Dispute and Auditing Procedures (Cont'd)

3. Contested Audits

- a. When a jurisdictional audit is conducted by the Company or an independent auditing firm selected by the Company, the audit results will be furnished to the customer by certified U.S. Mail (return receipt requested). The customer may contest the audit results by providing written notification (by certified U.S. Mail, return receipt requested), to the Company within fifteen (15) calendar days from the date the audit report is furnished to the customer by certified U.S. Mail (return receipt requested). When a jurisdictional audit is conducted by an independent auditing firm selected by the customer, the audit results will be furnished to the Company by certified U.S. Mail (return receipt requested). The Company may contest the audit results by providing written notification (by certified U.S. Mail, return receipt requested), to the customer within fifteen (15) calendar days from the date the audit report is furnished to the Company by certified U.S. Mail (return receipt requested).
- b. Contested audits will be resolved by the Company and the customer within thirty (30) days of written notification. If the dispute cannot be resolved by the customer and the Company, either party reserves the right to refer the matter to the Commission for resolution or use a mutually agreed upon neutral arbitrator as described in c. through e., following. The Commission retains jurisdiction over the matter of this dispute. During the initial thirty (30) day resolution period, the Company and the customer will review the audit process and the data used to calculate the PIU factor in an attempt to resolve the dispute. Should the Company and the customer resolve the dispute on the PIU factor, a neutral arbitrator would not be warranted.

EXHIBIT 4 - COMPETITIVE ACCESS

CenturyTel Broadband Services, Inc.

Supplement No. 1 to
Telephone Pa. P.U.C. Tariff No. 2
Section 2
Original Page 19

COMPETITIVE ACCESS SERVICES TARIFF

2. General Regulations

2.3 Obligations of The Customer

2.3.9 Jurisdictional Report Requirements

D.3. (Cont'd)

- c. Contested audits will be resolved by a neutral arbitrator mutually agreed upon by the Company and the customer. The arbitration hearing will be conducted in Denver, Colorado or a site that is mutually agreed upon by both parties. The arbitration proceeding, including the decision rendered, shall be governed by the law (both statutory and case) of the state in which the arbitration hearing is held, including but not limited to the Uniform Arbitration Act as adopted in that state.
- d. Prior to the arbitration hearing, each party shall notify the arbitrator of the PIU factor which that party believes to be correct. The arbitrator, in deciding, may adopt the PIU factor of either party or may adopt a PIU factor different from those proposed by the parties.
- e. If the arbitrator adopts a PIU factor proposed by one of the parties, the other party (whose PIU factor was not adopted) shall pay all costs of the arbitration. If the arbitrator adopts a PIU factor higher than the PIU factors proposed by both parties, then the party proposing the lower PIU factors shall pay all costs of the arbitration. If the arbitrator adopts a PIU factor lower than the PIU factor proposed by both parties, then the party proposing the higher PIU factor shall pay all costs of the arbitration. If the arbitrator adopts a PIU factor which falls between the two factors proposed by the parties, then the parties shall each pay one-half of the arbitration costs.
- f. Absent written notification, within the time frame as set forth preceding, audit results cannot be contested and the Company will adjust the customer's PIU factor based upon the audit results as set forth in C., preceding.

E. Application of PIU

When the Access Service is not available in the interstate jurisdiction, the PIU factor must be zero percent (0%).

EXHIBIT 4 - COMPETITIVE ACCESS

CenturyTel Broadband Services, Inc.

Supplement No. 1 to
Telephone Pa. P.U.C. Tariff No. 2
Section 2
Original Page 20

COMPETITIVE ACCESS SERVICES TARIFF

2. General Regulations

2.3 Obligations of The Customer (Cont'd)

2.3.10 Determination of Intrastate Charges for Mixed Interstate and Intrastate Access Service

A. PIU

When mixed interstate and intrastate Access Service is provided, all charges (i.e., nonrecurring, monthly and/or usage) including optional features charges, will be prorated between interstate and intrastate. The PIU factor provided in the jurisdictional reports as set forth in 2.3.9, preceding, will serve as the basis for prorating the charges. The percentage of an Access Service to be charged as intrastate is applied in the following manner:

1. For monthly and nonrecurring chargeable rate elements, multiply the percent intrastate use times the quantity of chargeable elements times the stated tariff rate per element. In the event that the customer has provided a separate percent interstate use for terminating access for FGD, the projected PIU factor for originating access minutes of use will be used to determine the apportionment of charges.
2. For usage sensitive (i.e., access minutes and calls) chargeable rate elements, multiply the percent intrastate use times actual use (i.e., measured or Company assumed average use) times the stated tariff rate.

The PIU factor will change as revised usage reports are submitted as set forth in 2.3.9, preceding.

EXHIBIT 4 - COMPETITIVE ACCESS

CenturyTel Broadband Services, Inc.

Supplement No. 1 to
Telephone Pa. P.U.C. Tariff No. 2
Section 2
Original Page 21

COMPETITIVE ACCESS SERVICES TARIFF

2. General Regulations

2.3 Obligations of The Customer

2.3.10 Determination of Intrastate Charges for Mixed Interstate and Intrastate Access Service (Cont'd)

B. Identification and Rating of VoIP-PSTN Traffic

VoIP-PSTN Traffic is defined as traffic exchanged between a Company end user and the customer in Time Division Multiplexing (TDM) format that originates and/or terminates in Internet Protocol (IP) format. This section governs the identification of VoIP-PSTN Traffic that is required to be compensated at interstate access rates unless the parties have agreed otherwise by the F.C.C. in its Report and Order in WC Dockets Nos. 10-90, etc., F.C.C. Release No. 11-161 (November 18, 2011) (F.C.C. Order).

The Company affirms that all of its Pennsylvania traffic either originates from or terminates to a VoIP end user and is therefore, VoIP PSTN. VoIP-PSTN Traffic identified in accordance with this tariff section will be billed at rates equal to the Company's applicable tariffed interstate switched access rates as set forth in CenturyTel Broadband Services, Inc. Tariff F.C.C. No. 1. These rates are contained in Sections 3.7.1 and 6.8.1, following.

EXHIBIT 4 - COMPETITIVE ACCESS

CenturyTel Broadband Services, Inc.

Supplement No. 1 to
Telephone Pa. P.U.C. Tariff No. 2
Section 2
Original Page 22

COMPETITIVE ACCESS SERVICES TARIFF

2. General Regulations

2.4 Payment Arrangements and Credit Allowances

2.4.1 Payment of Rates, Charges and Deposits

A. Deposits

1. The Company may, in order to safeguard its interests, require an applicant to make a suitable deposit to be held by the Company as a guarantee of the payment of charges.
2. For Access Service, a deposit will be required under the following conditions:
 - a. Applicant has had no previous Access Service; or
 - b. Applicant does not have verifiable credit with any CenturyLink anywhere within the region in the same or similar business; or
 - c. Applicant has had previous verifiable Access Service with the Company but has an outstanding and unpaid bill for Access Service; or has not established satisfactory credit. Satisfactory credit for an Access Service customer is defined as twelve consecutive months of service without a suspension of service for nonpayment or with no more than one notification of intent to suspend service for nonpayment.
 - d. Applicant for nonresidential service will be given credit for previous nonresidential service only if the applicant is same business entity to which such service was previously accorded.

EXHIBIT 4 - COMPETITIVE ACCESS

CenturyTel Broadband Services, Inc.

Supplement No. 1 to
Telephone Pa. P.U.C. Tariff No. 2
Section 2
Original Page 23

COMPETITIVE ACCESS SERVICES TARIFF

2. General Regulations

2.4 Payment Arrangements and Credit Allowances

2.4.1 Payment of Rates, Charges and Deposits

A. Deposits (Cont'd)

3. An initial deposit or an additional deposit will be required of an existing customer when high risk is indicated and existing security is insufficient. Such requirement will be imposed when payment history includes a suspension of service for nonpayment or includes more than one notification of intention to suspend service for nonpayment during the previous twelve month period.
4. The Company reserves the right to provide for installment payment of the deposit if the circumstances warrant.
5. Any deposit required of an existing customer is due and payable within ten days after the requirement is imposed. This requirement shall be in writing and the payment date shall be on or after the due and payable date for the current bill. If said deposit or installment thereof, as appropriate, is not paid within the aforementioned time frame, the Company may suspend service of the customer without further notice. The following are exceptions to this provision:
 - a. In the event service is suspended for a customer for nonpayment, an initial or additional deposit shall be required prior to the restoration of service if existing security is insufficient.
 - b. In the event prior indebtedness or prior unsatisfactory credit has been determined subsequent to the initial establishment of service due to misrepresentation of the facts by the customer, a deposit shall be due and payable within five days upon verbal notification and written confirmation or within ten days when notification can only be provided in writing. The ten day period shall be measured from the mailed date of the written notice. If said deposit is not paid within the aforementioned time frame, the Company may suspend service to the customer without further notice.

EXHIBIT 4 - COMPETITIVE ACCESS

CenturyTel Broadband Services, Inc.

Supplement No. 1 to
Telephone Pa. P.U.C. Tariff No. 2
Section 2
Original Page 24

COMPETITIVE ACCESS SERVICES TARIFF

2. General Regulations

2.4 Payment Arrangements and Credit Allowances

2.4.1 Payment of Rates, Charges and Deposits

A. Deposits (Cont'd)

6. The amount of the deposit shall be the estimated charges for the Access Service which will accrue for a two-month period. All applicants and existing customers shall be treated uniformly for the determination and application of deposits.
7. When it is determined that a deposit is required under the conditions specified above, the applicant or customer may, in lieu of or in addition to making the deposit, arrange for an acceptable third party to guarantee payment of his charges by executing on his behalf a Guarantee of Payment Agreement with the Company. An acceptable third party guarantor for Access Service is a current nonresidential customer with at least two years' continuous service, whose payment history for the most recent twelve month period is satisfactory.
8. The fact that a deposit has been made in no way relieves the customer from complying with the Company's regulations as to advance payments as set forth in B., following, or the prompt payment of bills on presentation.
9. The deposit will bear interest as required by state law or regulations.
10. When the customer is a candidate for political office or is a person or organization acting on behalf of a candidate for political office the deposit requirement will be adjusted monthly to reflect twice the current month's actual billing. Under these circumstances, a security, i.e., surety bond or bank letter of credit equal to the Company's deposit requirement will be the only acceptable substitutes for a cash deposit.
11. When the service is terminated, the amount of the initial or additional deposit, with any interest due, will be credited to the customer's account and any credit balance which may remain will be refunded. After an existing customer has established satisfactory credit, the amount of the deposit, with any interest due, will be either credited to the account or at the option of the customer, refunded. Satisfactory credit for an Access Service customer is defined as twelve consecutive months of Access Service without a suspension for nonpayment and with no more than one notification of intent to suspend service for nonpayment.

EXHIBIT 4 - COMPETITIVE ACCESS

CenturyTel Broadband Services, Inc.

Supplement No. 1 to
Telephone Pa. P.U.C. Tariff No. 2
Section 2
Original Page 25

COMPETITIVE ACCESS SERVICES TARIFF

2. General Regulations

2.4 Payment Arrangements and Credit Allowances

2.4.1 Payment of Rates, Charges and Deposits (Cont'd)

B. Advance Payments

1. In accordance with the Company's practice of requiring that all regularly recurring charges for services be paid monthly in advance, an applicant for service may be required to pay in advance at the time application for service is made, the nonrecurring charges applicable, together with at least one month's charges for the services applied for, and where necessary, in the opinion of the Company, the estimated amount of construction charges.

2. The amount of the advance payment will be credited to the customer's account and applied to any indebtedness under the contract for service furnished, and for nonrecurring charges.

- ###### C. The Company shall bill on a current basis all charges incurred by and credits due to the customer under this Tariff attributable to services established or discontinued during the preceding billing period. In addition, the Company shall bill in advance charges for all services to be provided during the ensuing billing period except for charges associated with service usage and for the Federal Government which will be billed in arrears. The bill day (i.e., the billing date of a bill for a customer for Access Service under this Tariff), the period of service each bill covers and the payment date will be as follows:

1. The Company will establish a bill day each month for each customer account. The bill will cover nonusage sensitive service charges for the ensuing billing period and any known unbilled nonusage sensitive charges. Any known unbilled usage charges for prior periods and any known unbilled adjustments will be applied to this bill. Payment for such bills is due as set forth in 2., following. If payment is not received by the payment due date, as set forth in 2., following, in immediately available funds, a late payment penalty will apply as set forth in 2., following.

EXHIBIT 4 - COMPETITIVE ACCESS

CenturyTel Broadband Services, Inc.

Supplement No. 1 to
Telephone Pa. P.U.C. Tariff No. 2
Section 2
Original Page 26

COMPETITIVE ACCESS SERVICES TARIFF

2. General Regulations

2.4 Payment Arrangements and Credit Allowances

2.4.1 Payment of Rates, Charges and Deposits

C. (Cont'd)

2. All bills dated as set forth in 1., preceding, for service, provided to the customer by the Company are due (payment due date) by the next bill date (i.e., same date in the following month as the bill date), except as provided herein, and are payable in immediately available funds. If such payment due date would cause payment to be due on a Saturday, Sunday or holiday (i.e., New Year's Day, Independence Day, Labor Day, Thanksgiving Day, Christmas Day, Veteran's Day and a day when Washington's Birthday, Memorial Day or Columbus Day is legally observed), payment for such bills will be due from the customer as follows:
 - a. If such payment due date falls on a Sunday or on a holiday which is observed on a Monday, the payment due date shall be the first non-holiday day following such Sunday or holiday. If such payment due date falls on a Saturday or on a holiday which is observed on Tuesday, Wednesday, Thursday or Friday, the payment due date shall be the last non-holiday day preceding such Saturday or holiday.
 - b. Further, if any portion of the payment is received by the Company after the payment due date as set forth above, or if any portion of the payment is received by the Company in funds which are not immediately available to the Company, then a late payment penalty shall be due to the Company. The late payment penalty shall be the portion of the payment not received by the payment due date times a late factor. The late factor shall be the lesser of:
 - (1) The highest interest rate (in decimal value) which may be levied by law for commercial transactions, compounded daily for the number of days from the payment due date to and including the date that the customer actually makes the payment to the Company, or
 - (2) 0.000407 per day, compounded daily for the number of days from the payment due date to and including the date that the customer actually makes the payment to the Company.

EXHIBIT 4 - COMPETITIVE ACCESS

CenturyTel Broadband Services, Inc.

Supplement No. 1 to
Telephone Pa. P.U.C. Tariff No. 2
Section 2
Original Page 27

COMPETITIVE ACCESS SERVICES TARIFF

2. General Regulations

2.4 Payment Arrangements and Credit Allowances

2.4.1 Payment of Rates, Charges and Deposits

C.2. (Cont'd)

- c. In the event of a billing dispute, the customer must submit a documented claim for the disputed amount. If the claim is submitted within 90 days of the payment due date, any interest credits due the customer upon resolution of the dispute shall be calculated from the bill payment date. If the customer submits a claim for the disputed amount more than 90 days from the payment due date, any interest credits due the customer upon resolution of the dispute shall be calculated from the later of the date the claim was submitted, or the bill payment date. Any undisputed amounts withheld by the customer in conjunction with disputed amounts withheld, shall be subject to the late payment penalty, as set forth in a., preceding. The Company will resolve the dispute and assess interest credits or penalties to the customer as follows:
- (1) If the dispute is resolved in favor of the Company and the customer has paid the disputed amount on or before the payment due date, no interest credits or penalties will apply.
 - (2) If the dispute is resolved in favor of the Company and the customer has withheld the disputed amount, any payments withheld pending settlement of the dispute shall be subject to the late payment penalty as set forth in b., preceding.
 - (3) If the dispute is resolved in favor of the customer and the customer has withheld the disputed amount, no interest credits or penalties will apply.

EXHIBIT 4 - COMPETITIVE ACCESS

CenturyTel Broadband Services, Inc.

Supplement No. 1 to
Telephone Pa. P.U.C. Tariff No. 2
Section 2
Original Page 28

COMPETITIVE ACCESS SERVICES TARIFF

2. General Regulations

2.4 Payment Arrangements and Credit Allowances

2.4.1 Payment of Rates, Charges and Deposits

C.2.c. (Cont'd)

- (4) If the dispute is resolved in favor of the customer and the customer has paid the disputed amount, the customer will receive an interest credit from the Company for the disputed amount times a late factor. The late factor shall be the lesser of:
 - (a) The highest interest rate (in decimal value) which may be levied by law for commercial transactions, compounded daily for the number of days from the date when payment was made or credit claimed in accordance with b., preceding, to and including the payment due date (as set forth in 2., preceding) of the bill that reflects the credit for the disputed amount. In the event that the Company agrees to refund a credit by check or wire transfer, interest will be applied up to and including the date of issuance for either the check or wire transfer.
 - (b) 0.000407 per day, compounded daily for the number of days from the date when payment was made or credit claimed in accordance with b., preceding, to and including the payment due date (as set forth in 2., preceding) of the bill that reflects the credit for the disputed amount. In the event that the Company agrees to refund a credit by check or wire transfer, interest will be applied up to and including the date of issuance for either the check or wire transfer.
- D. Adjustments for the quantities of services established or discontinued in any billing period beyond the minimum period set forth for services in other sections of this Tariff will be prorated to the number of days or major fraction of days based on a 30 day month. The Company will, upon request and if available, furnish such detailed information as may reasonably be required for verification of any bill.
- E. When a rate as set forth in this Tariff is shown to have more than two decimal places, the charges will be determined using the rate shown. The resulting amount will then be rounded to the nearest penny (i.e., rounded to two decimal places).

EXHIBIT 4 - COMPETITIVE ACCESS

CenturyTel Broadband Services, Inc.

Supplement No. 1 to
Telephone Pa. P.U.C. Tariff No. 2
Section 2
Original Page 29

COMPETITIVE ACCESS SERVICES TARIFF

2. General Regulations

2.4 Payment Arrangements and Credit Allowances(Cont'd)

2.4.2 Minimum Periods

- A. The minimum period for which services are provided and for which rates and charges are applicable is one month unless otherwise specified.
- B. When a service is discontinued prior to the expiration of the minimum period, charges are applicable, whether the service is used or not, as follows:
 - 1. When a service with a one month minimum period is discontinued prior to the expiration of the minimum period, a one month charge will apply at the rate level in effect at the time service is discontinued.
 - 2. When a service with a minimum period greater than one month is discontinued prior to the expiration of the minimum period, the applicable charge will be the lesser of (1) the Company's total non-recoverable costs less the net salvage value for the discontinued service or (2) the total monthly charges, at the rate level in effect at the time service is discontinued, for the remainder of the minimum period.

2.4.3 Cancellation of An Order for Service

Provisions for the cancellation of an order for service are set forth in Section 5, following.

2.4.4 Cancellation for Cause

The Company, by written notice to the customer, may immediately discontinue the furnishing of Access Service without incurring any liability upon:

- A. Nonpayment of any sum due the Company, or
- B. A violation of any condition governing the furnishing of service.

EXHIBIT 4 - COMPETITIVE ACCESS

CenturyTel Broadband Services, Inc.

Supplement No. 1 to
Telephone Pa. P.U.C. Tariff No. 2
Section 2
Original Page 30

COMPETITIVE ACCESS SERVICES TARIFF

2. General Regulations

2.4 Payment Arrangements and Credit Allowances (Cont'd)

2.4.5 Credit Allowance for Service Interruptions

A. General

A service is interrupted when it becomes unusable to the customer because of a failure of a facility component used to furnish service under this Tariff or in the event that the protective controls applied by the Company result in the complete loss of service by the customer as set forth in 6.5.1, following. An interruption period starts when an inoperative service is reported to the Company, and ends when the service is operative.

Reports of an inoperative service will be taken only from the customer of record for that particular service.

B. When a Credit Allowance Applies

When main telephone service is interrupted for a period of at least 24 hours, the Company, after due notice by the customer, shall apply the following schedule of allowances except in situations as provided for in 3., following:

1. One-thirtieth of the tariff monthly rate of services and facilities furnished by the Company rendered inoperative, useless or impaired for each of the first three full 24-hour periods during which the interruption continues after notice by the customer to the Company conditioned that the out-of-service extends beyond a minimum of 24 hours.
2. Two-thirtieths of each full 24-hour period beyond the first three 24-hour periods. However, in no instance may the allowance for the out-of-service period exceed the total charges in a billing period for the service and facilities furnished by the Company rendered useless or impaired.
3. When service is interrupted for a period of at least 24 hours due to such factors as storms, fires, floods or other conditions beyond the control of the Company, an allowance of 1/30 of the tariff monthly rate for all services and facilities furnished by the Company rendered inoperative or substantially impaired to the extent of being useless shall apply for each full 24 hours during which the interruption continues after notice by the customer to the Company.

EXHIBIT 4 - COMPETITIVE ACCESS

CenturyTel Broadband Services, Inc.

Supplement No. 1 to
Telephone Pa. P.U.C. Tariff No. 2
Section 2
Original Page 31

COMPETITIVE ACCESS SERVICES TARIFF

2. General Regulations

2.4 Payment Arrangements and Credit Allowances

2.4.5 Credit Allowance for Service Interruptions

B. When a Credit Allowance Applies (Cont'd)

4. The allowances set forth in 1. – 3., preceding may not be applicable where service is interrupted by the negligence or willful act of the customer to service or where the Company, pursuant to the terms of the contract for service, suspends or terminates service for nonpayment of charges or for unlawful or improper use of the facilities or service or for any other reason provided for in the filed and effective tariff.

C. When A Credit Allowance Does Not Apply

No credit allowance will be made for:

1. Interruptions caused by the negligence of the customer.
2. Interruptions of a service due to the failure of equipment or systems provided by the customer or others.
3. Interruptions of a service during any period in which the Company is not afforded access to the premises where the service is terminated.
4. Interruptions of a service when the customer has released that service to the Company for maintenance purposes, to make rearrangements, or for the implementation of an order for a change in the service during the time that was negotiated with the customer prior to the release of that service. Thereafter, a credit allowance as set forth in B., preceding, applies.
5. Periods when the customer elects not to release the service for testing and/or repair and continues to use it on an impaired basis.
6. Periods of temporary discontinuance as set forth in 2.2.1.B., preceding.
7. An interruption or a group of interruptions, resulting from a common cause that would amount to an adjustment of less than one dollar.

EXHIBIT 4 - COMPETITIVE ACCESS

CenturyTel Broadband Services, Inc.

Supplement No. 1 to
Telephone Pa. P.U.C. Tariff No. 2
Section 2
Original Page 32

COMPETITIVE ACCESS SERVICES TARIFF

2. General Regulations

2.4 Payment Arrangements and Credit Allowances

2.4.5 Credit Allowance for Service Interruptions (Cont'd)

D. Use of an Alternative Service Provided by the Company

Should the customer elect to use an alternative service provided by the Company during the period that a service is interrupted, the customer must pay the tariffed rates and charges for the alternative service used.

E. Temporary Surrender of a Service

In certain instances, the customer may be requested by the Company to surrender a service for purposes other than maintenance, testing or activity relating to a service order. If the customer consents, a credit allowance will be granted. The credit allowance will be 1/1440 of the monthly rate for each period of 30 minutes or fraction thereof that the service is surrendered. In no case will the credit allowance exceed the monthly rate for the service surrendered in any one monthly billing period.

2.4.6 Reestablishment of Service Following Fire, Flood or Other Occurrence

A. Nonrecurring Charges Do Not Apply

Charges do not apply for the reestablishment of service following a fire, flood or other occurrence attributed to an Act of God provided that:

1. The service is of the same type as was provided prior to the fire, flood or other occurrence.
2. The service is for the same customer.
3. The service is at the same location on the same premises.
4. The reestablishment of service begins within 60 days after Company service is available. (The 60 day period may be extended a reasonable period if the renovation of the original location on the premises affected is not practical within the allotted time period).

EXHIBIT 4 - COMPETITIVE ACCESS

CenturyTel Broadband Services, Inc.

Supplement No. 1 to
Telephone Pa. P.U.C. Tariff No. 2
Section 2
Original Page 33

COMPETITIVE ACCESS SERVICES TARIFF

2. General Regulations

2.4 Payment Arrangements and Credit Allowances

2.4.6 Reestablishment of Service Following Fire, Flood or Other Occurrence (Cont'd)

B. Nonrecurring Charges Apply

Nonrecurring charges apply for establishing service at a different location on the same premises or at a different premises pending reestablishment of service at the original location.

2.4.7 Title or Ownership Rights

The payment of rates and charges by customers for the services offered under the provisions of this Tariff does not assign, confer or transfer title or ownership rights to proposals or facilities developed or utilized, respectively, by the Company in the provision of such services.

EXHIBIT 4 - COMPETITIVE ACCESS

CenturyTel Broadband Services, Inc.

Supplement No. 1 to
Telephone Pa. P.U.C. Tariff No. 2
Section 2
Original Page 34

COMPETITIVE ACCESS SERVICES TARIFF

2. General Regulations

2.4 Payment Arrangements and Credit Allowances (Cont'd)

2.4.8 Ordering, Rating and Billing of Access Services Where More Than One company Is Involved

All information necessary for billing, ordering and design coordination will be provided based on the standards in the Multiple Exchange Carriers Access Billing Guidelines (MECAB) and the Multiple Exchange Carriers Ordering and Design Guidelines (MECOD) to ensure that jointly provided Access Services are installed, tested and turned up in a timely manner.

Company and Third Party Carrier will render separate bills as follows:

- Each company involved will accept the order from the customer.
- Each company will provide it's portion of the Transport element and will bill the charges in accordance with its Access Service Tariff or contract, if appropriate. All other appropriate charges in each company's tariff are applicable.
- Each company will render bills for nonrecurring charges as they are incurred. Bills for recurring rates will not be rendered until the service ordered can be provided by all of the companies involved.
- Each company will determine the appropriate Transport by computing the airline mileage between the two ends of the Transport element using the V & H methods as set forth in 6.7.7, following.
- Each company will determine the rate for the airline mileage as set forth above, using it's Tariff. Multiply such rate by the company's billing percentage factor and divide by 100 to obtain the Transport element charges.

The billing percentages will be agreed upon by the companies involved.

EXHIBIT 4 - COMPETITIVE ACCESS

CenturyTel Broadband Services, Inc.

Supplement No. 1 to
Telephone Pa. P.U.C. Tariff No. 2
Section 2
Original Page 35

COMPETITIVE ACCESS SERVICES TARIFF

2. General Regulations

2.4 Payment Arrangements and Credit Allowances

2.4.8 Ordering, Rating and Billing of Access Services Where More Than One company Is Involved (Cont'd)

- A. When jointly provisioned Access Service is provided between the Company and a LEC Tandem, the appropriate Tandem Transmission and End Office rate elements will be applied.

For Switched Access Service, the recurring rates will be applied as follows: 1) multiply the Tandem Transmission fixed rate by the minutes of use (MOU) by the billing percentage (BP), 2) multiply the Tandem Transmission per-mile rate by the number of miles, by the MOU, by the BP, and 3) all other appropriate Switched Access recurring rate elements at 100 percent, if applicable.

The tandem owner in this example, (LEC) will assess the Tandem Switching rate. If the Company is the tandem owner, the Company will assess the Tandem Switching Rate.

- B. When jointly provisioned Access Service is provided between the Company and a Third Party Carrier, the appropriate nonrecurring charges shall apply, however the BP is not applied to nonrecurring charges.

EXHIBIT 4 - COMPETITIVE ACCESS

CenturyTel Broadband Services, Inc.

Supplement No. 1 to
Telephone Pa. P.U.C. Tariff No. 2
Section 2
Original Page 36

COMPETITIVE ACCESS SERVICES TARIFF

2. General Regulations

2.4 Payment Arrangements and Credit Allowances

2.4.8 Ordering, Rating and Billing of Access Services Where More Than One company Is Involved (Cont'd)

C. Example 1 - Switched Access provisioned by LEC Tandem Routing

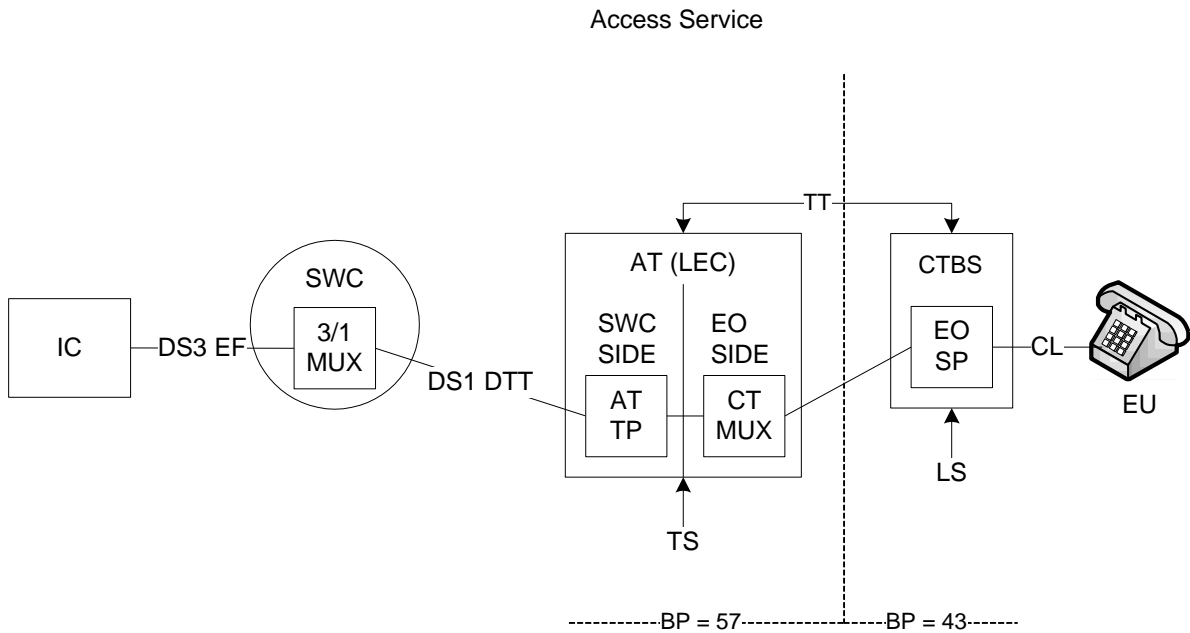

- AT – Access Tandem
- ATTP – Access Tandem Trunk Port
- BP – Billing Percentage
- CL – Common Line
- CT MUX – Common Transport Multiplexer
- DTT – Direct Trunked Transport
- EF – Entrance Facility
- EO SP – End Office Shared Port
- EU – End User
- IC – Interexchange Carrier
- LEC – Local Exchange Carrier
- MUX – Multiplexer
- SWC – Serving Wire Center
- TS – Tandem Switching
- TT – Tandem Transmission

EXHIBIT 4 - COMPETITIVE ACCESS

CenturyTel Broadband Services, Inc.

Supplement No. 1 to
Telephone Pa. P.U.C. Tariff No. 2
Section 2
Original Page 37

COMPETITIVE ACCESS SERVICES TARIFF

2. General Regulations

2.4 Payment Arrangements and Credit Allowances

2.4.8 Ordering, Rating and Billing of Access Services Where More Than One company Is Involved

C. Example 1 - Switched Access provisioned by LEC Tandem Routing (Cont'd)

1. Layout

- a. Feature Group D Switched Access is ordered to a Company end office via LEC Tandem Routing.
- b. The premises of the ordering customer and the serving wire center (SWC) of that premises, and the access tandem are associated with the LEC.
- c. The customer orders a DS3 Entrance Facility from the customer's premises to the SWC with a 3/1 MUX in the SWC.
- d. The customer orders a DS1 DTT to the AT.
- e. The BP for Tandem Transmission is 57 for the LEC.
- f. The end office is associated with the Company.
- g. The BP for Tandem Transmission is 43 for the Company.

EXHIBIT 4 - COMPETITIVE ACCESS

CenturyTel Broadband Services, Inc.

Supplement No. 1 to
Telephone Pa. P.U.C. Tariff No. 2
Section 2
Original Page 38

COMPETITIVE ACCESS SERVICES TARIFF

2. General Regulations

2.4 Payment Arrangements and Credit Allowances

2.4.8 Ordering, Rating and Billing of Access Services Where More Than One company Is Involved

C. Example 1 - Switched Access provisioned by LEC Tandem Routing (Cont'd)

2. Rate elements assessed per telephone company

a. LEC

- Entrance Facility -100% of DS3 monthly Entrance Facility rate
- MUX -100% of monthly 3/1 MUX rate
- DS1 DTT -100% of DS1 monthly DTT rate
- ATTP -100% of ATTP monthly rate
- Tandem Switching -MOU rate X MOU
- Common Transport MUX -MOU rate X MOU
- Tandem Transmission -Fixed rate X MOU X 0.57
- Tandem Transmission -Per-mile rate X number of miles X MOU X 0.57

b. Company

- Tandem Transmission -Fixed rate X MOU X 0.43
- Tandem Transmission -Per-mile rate X number of miles X MOU X 0.43
- Local Switching -MOU rate X MOU
- End Office Shared Port -MOU rate X MOU
- Common Line -MOU rate X MOU

EXHIBIT 4 - COMPETITIVE ACCESS

CenturyTel Broadband Services, Inc.

Supplement No. 1 to
Telephone Pa. P.U.C. Tariff No. 2
Section 2
Original Page 39

COMPETITIVE ACCESS SERVICES TARIFF

2. General Regulations

2.5 Connections

2.5.1 General

Equipment and Systems (i.e., terminal equipment, multiline terminating systems and communications systems) may be connected with Switched Access Service furnished by the Company where such connection is made in accordance with Industry Standards.

EXHIBIT 4 - COMPETITIVE ACCESS

CenturyTel Broadband Services, Inc.

Supplement No. 1 to
Telephone Pa. P.U.C. Tariff No. 2
Section 2
Original Page 40

COMPETITIVE ACCESS SERVICES TARIFF

2. General Regulations

2.6 Definitions

Certain terms used herein are defined as follows:

Access Minutes

Denotes that usage of exchange facilities in intrastate service for the purpose of calculating chargeable usage. On the originating end of an intrastate call, usage is measured from the time the originating end user's call is delivered by the Company to and acknowledged as received by the customer's facilities connected with the originating exchange. On the terminating end of an intrastate call, usage is measured from the time the call is received by the end user in the terminating exchange. Timing of usage at both originating and terminating ends of an intrastate call shall terminate when the calling or called party disconnects, whichever event is recognized first in the originating and terminating exchanges, as applicable.

Access Tandem

Denotes a switching system that provides a concentration and distribution function for originating or terminating traffic between end offices and a customer's POT.

Bit

Denotes the smallest unit of information in the binary system of notation.

Business Day (BD)

Denotes the times of day that a company is open for business. Generally, in the business community, these are 8:00 a.m. to 5:00 p.m., with an hour for lunch, Monday through Friday, resulting in a standard forty (40) hour work week. However, Business Day hours for the Company may vary based on Company policy, union contract and location.

EXHIBIT 4 - COMPETITIVE ACCESS

CenturyTel Broadband Services, Inc.

Supplement No. 1 to
Telephone Pa. P.U.C. Tariff No. 2
Section 2
Original Page 41

COMPETITIVE ACCESS SERVICES TARIFF

2. General Regulations

2.6 Definitions (Cont'd)

Call

Denotes a customer attempt for which the complete address code (e.g., 0-, 911, or 10 digits) is provided to the serving dial tone office.

Calling Party Number (CPN)

Denotes the SS7 Out of Band Signaling parameter which automatically transmits the calling party's ten digit telephone number to the customer's premises for calls originating in the LATA.

Carrier or Common Carrier

See "Interexchange Carrier", "Local Exchange Carrier", "Commercial Mobile Radio Service Provider", "Third Party Carrier".

CCS

Denotes a hundred call seconds, which is a standard unit of traffic load that is equal to 100 seconds of usage or capacity of a group of servers (e.g., trunks).

Channel(s)

Denotes an electrical or photonic, in the case of fiber optic-based transmission systems, communications path between two or more POTs.

Charge Number (CN)

Denotes the SS7 Out of Band Signaling parameter which is equivalent to the ten digit ANI telephone number.

EXHIBIT 4 - COMPETITIVE ACCESS

CenturyTel Broadband Services, Inc.

Supplement No. 1 to
Telephone Pa. P.U.C. Tariff No. 2
Section 2
Original Page 42

COMPETITIVE ACCESS SERVICES TARIFF

2. General Regulations

2.6 Definitions (Cont'd)

Commercial Mobile Radio Service (CMRS) Provider

Denotes a common carrier as defined by the Federal Communications Commission subject to the Rules set forth in Section 332 of the Communications Act.

Communications System

Denotes channels and other facilities which are capable of communications between terminal equipment provided by other than the Company.

Contract

Denotes the service agreement between a customer and the Company under which facilities for communication between specified locations, for designated periods, and for the use of the customer and the authorized users specifically named in the contract are furnished in accordance with the provisions of this Tariff.

Customer(s)

Denotes any individual, partnership, association, joint-stock company, trust, corporation, governmental entity or any other entity which subscribes to the services offered under this Tariff based on the Application of Tariff as set forth in 1.1, preceding.

Demarcation Point

See "Point of Termination (POT)".

Direct-Trunked Transport (DTT)

Denotes the transport between the SWC of the customer's premises and a tandem.

EXHIBIT 4 - COMPETITIVE ACCESS

CenturyTel Broadband Services, Inc.

Supplement No. 1 to
Telephone Pa. P.U.C. Tariff No. 2
Section 2
Original Page 43

COMPETITIVE ACCESS SERVICES TARIFF

2. General Regulations

2.6 Definitions (Cont'd)

End Office Switch

Denotes a local Company switching system where Telephone Exchange Service customer station loops are terminated for purposes of interconnection to trunks.

End User (EU)

Denotes any customer of an intrastate telecommunications service that is not a carrier shall be deemed to be an "end user" when such carrier (other than the Company) uses a telecommunications service for administrative purposes. A person or entity other than an IC that offers telecommunications services exclusively as a reseller shall be deemed to be an "end user" if all resale transmissions offered by such reseller originate or terminate on the premises of such reseller.

Entrance Facility (EF)

Denotes the dedicated transport facility from the customer's premises or point of demarcation to the SWC for Switched Access Service.

Entry Switch

See "First Point of Switching".

Exchange

Denotes a unit generally smaller than a Local Access and Transport Area, established for the administration of communications service in a specified area which usually embraces a city, town, or village and its environs. It consists of one or more central offices together with the associated facilities used in furnishing communications service within that area. The exchange may include any Extended Area Service (EAS) area that is an enlargement of a Company's exchange area to include nearby exchanges. One or more designated exchanges comprise a given Local Access and Transport Area.

EXHIBIT 4 - COMPETITIVE ACCESS

CenturyTel Broadband Services, Inc.

Supplement No. 1 to
Telephone Pa. P.U.C. Tariff No. 2
Section 2
Original Page 44

COMPETITIVE ACCESS SERVICES TARIFF

2. General Regulations

2.6 Definitions (Cont'd)

First Point of Switching

Denotes the first Company location at which switching occurs on the terminating path of a call proceeding from the customer's premises to the terminating end office and, at the same time, the last Company location at which switching occurs on the originating path of a call proceeding from the originating end office to the customer's premises.

Immediately Available Funds

Denotes a corporate or personal check drawn on a bank account and funds which are available for use by the receiving party on the same day on which they are received and include U.S. Federal Reserve bank wire transfers, U.S. Federal Reserve notes (paper cash), U.S. coins, U.S. Postal Money Orders and New York Certificates of Deposit.

Individual Case Basis (ICB)

Denotes a condition in which the terms and conditions, if applicable, rates and charges for an offering are developed based on the circumstances in each case.

Interexchange Carrier (IC) or Interexchange Common Carrier

Denotes any individual, partnership, association, joint-stock company, trust, governmental entity or corporation engaged for hire in intrastate communication by wire or radio between two or more exchanges.

Interstate Communications

Denotes both interstate and foreign communications.

Intrastate Communications

Denotes any communications within a state subject to oversight by a state regulatory commission as provided by the laws of the state involved.

EXHIBIT 4 - COMPETITIVE ACCESS

CenturyTel Broadband Services, Inc.

Supplement No. 1 to
Telephone Pa. P.U.C. Tariff No. 2
Section 2
Original Page 45

COMPETITIVE ACCESS SERVICES TARIFF

2. General Regulations

2.6 Definitions (Cont'd)

Local Access and Transport Area (LATA)

Denotes a geographic area established for the provision and administration of communications service. It encompasses one or more designated exchanges, which are grouped to serve common social, economic and other purposes.

Local Exchange Carrier (LEC)

Local Exchange Carrier (LEC) means any carrier that is engaged in the provision of telephone Exchange Service or Exchange Access. Such term does not include a carrier insofar as such carrier is engaged in the provision of a commercial mobile service under Section 332 of the Act, except to the extent that the FCC finds that such service should be included in the definition of such term.

Major Fraction Thereof

Denotes any period of time in excess of 1/2 of the stated amount of time. As an example, in considering a period of 24 hours, a major fraction thereof would be any period of time in excess of 12 hours exactly. Therefore, if a given service is interrupted for a period of thirty six hours and fifteen minutes, the customer would be given a credit allowance for two twenty four hour periods for a total of forty eight hours.

Message

Denotes a "call" as defined preceding.

Milliwatt (102 Type) Test Line

Denotes an arrangement in an end office which provides a 1004 Hz tone at 0 dBm0 for one-way transmission measurements towards the customer's premises from the Company end office.

EXHIBIT 4 - COMPETITIVE ACCESS

CenturyTel Broadband Services, Inc.

Supplement No. 1 to
Telephone Pa. P.U.C. Tariff No. 2
Section 2
Original Page 46

COMPETITIVE ACCESS SERVICES TARIFF

2. General Regulations

2.6 Definitions (Cont'd)

Multiplexing (MUX)

Denotes a method of concentrating information via signal processing techniques (i.e., frequency division, multiplexing, time division multiplexing, etc.)

Non-Toll Free

All calls that are not toll free (8YY) as established by the FCC's 8YY Access Charge Reform Order (FCC 20-143) released on October 9, 2020.

Nonrecurring Charge

Denotes those charges which are one time charges to the customer, i.e., not monthly charges.

North American Numbering Plan (NANP)

Denotes a numbering scheme which includes a three-digit (Numbering Plan Area) code and a seven-digit telephone number which consists of a three-digit central office code plus a four-digit station number.

Office Replacement

Denotes a situation where the hardware and software in a Company switching office is replaced with different hardware and software for the establishment and maintenance of a given switching office.

Originating Direction

Denotes the use of Access Service for the origination of calls from an end user's premises to a customer's premises.

Percent Interstate Use (PIU)

The term "Percent Interstate Use" (PIU) refers to traffic that originates in one state and terminates in a different state.

EXHIBIT 4 - COMPETITIVE ACCESS

CenturyTel Broadband Services, Inc.

Supplement No. 1 to
Telephone Pa. P.U.C. Tariff No. 2
Section 2
Original Page 47

COMPETITIVE ACCESS SERVICES TARIFF

2. General Regulations

2.6 Definitions (Cont'd)

Point of Termination (POT)

Denotes a point at or near a customer-designated premises at which the Company's responsibility for the provision of Access Service ends.

Premises

Denotes a building, or a portion of a building in a multitenant building, or buildings on continuous property (except railroad rights-of-way, etc.) not separated by a public highway. It may also denote a customer-owned enclosure or utility vault located above ground or underground on private property or on customer acquired right-of-way. This term is not to be limited to one building, but applies as well to a complex, or campus-type configuration of buildings.

Query

Denotes the inquiry to a Company data base to obtain information, processing instructions or service data.

Release Message

Denotes a SS7 message sent in either direction to indicate the release of a specific circuit.

Serving Wire Center (SWC)

Denotes the local office from which dial tone for local exchange service would normally be provided to the customer's premises.

EXHIBIT 4 - COMPETITIVE ACCESS

CenturyTel Broadband Services, Inc.

Supplement No. 1 to
Telephone Pa. P.U.C. Tariff No. 2
Section 2
Original Page 48

COMPETITIVE ACCESS SERVICES TARIFF

2. General Regulations

2.6 Definitions (Cont'd)

Signaling

Denotes the process of passing information, identifying the called subscriber or addressee and for supervising and controlling the connection once it has been established.

Signaling System 7 (SS7)

Denotes the signaling protocol.

Switching System

Denotes the hardware and/or software utilized by the Company for the establishment and maintenance of a given wire center.

Tandem-Switched Transport (TST)

Denotes the transport between an access tandem and Company end office that subtends the access tandem that utilizes tandem switching functions. Tandem-Switched Transport consists of circuits used in common by multiple customers from the tandem to an end office.

Terminating Direction

Denotes the use of Access Service for the completion of calls from a customer's premises to an end user's premises.

Third Party Carrier

A Local Exchange Carrier or CMRS provider other than the Company.

Toll Free Code (TFC)

The term "Toll Free Code" denotes a three-digit Numbering Plan Area (NPA) or Area Code that is specifically assigned by the telecommunications industry for use by Telecommunications Service Providers in the provision of telephone numbers that, unlike traditional telephone numbers and calls, when dialed are toll free to the originating caller. The specific codes assigned and used, or reserved for use, for this purpose are 800, 822, 833, 844, 855, 866, 877, and 888.

EXHIBIT 4 - COMPETITIVE ACCESS

CenturyTel Broadband Services, Inc.

Supplement No. 1 to
Telephone Pa. P.U.C. Tariff No. 2
Section 2
Original Page 49

COMPETITIVE ACCESS SERVICES TARIFF

2. General Regulations

2.6 Definitions (Cont'd)

Toll Free Data Base Access Service

Toll Free Data Base Access Service is a service offering utilizing originating trunk side Switched Access Service. The service provides for the forwarding of end user dialed Toll Free calls to a Company Service Switching Point which will initiate a query to the data base to perform the Customer identification and delivery function. The call is forwarded to the appropriate Customer based on the dialed Toll Free number. Toll Free Data Base Access Service is comprised of the following elements:

1) Basic Query – Customer Identification Charge

The Toll Free Data Base Access Service Basic Query Charge applies for the identification of the appropriate Customer and delivery of the dialed 800 ten digit number. The charge is assessed to the Customer on a per query basis and may include an area of service which may range from a single NPA/NXX to an area consisting of all LATAs and NPAs. The Toll Free Basic Query Charge is set forth in 6.8.1, following.

2) Complex Query – Vertical Feature Charge

The Toll Free Data Base Access Service Complex Query Charge provides feature functionality in addition to the basic query. The feature package may include various destination options such as POTS Translation, carrier selection, time of day routing, day of week routing, specific date routing, geographic routing, routing based on percent of allocation, and emergency routing profiles. The Toll Free Complex Query Charge is set forth in 6.8.1, following.

Toll VoIP-PSTN Traffic

The term Toll VoIP-PSTN Traffic denotes a customer's interexchange voice traffic exchanged with the Telephone Company in Time Division Multiplexing format over PSTN facilities, which originates and/or terminates in Internet Protocol (IP) format. Toll VoIP-PSTN Traffic originates and /or terminates in IP format when it originates from and/or terminates to an end user customer of a service that requires IP-compatible customer premises equipment.

EXHIBIT 4 - COMPETITIVE ACCESS

CenturyTel Broadband Services, Inc.

Supplement No. 1 to
Telephone Pa. P.U.C. Tariff No. 2
Section 2
Original Page 50

COMPETITIVE ACCESS SERVICES TARIFF

2. General Regulations

2.6 Definitions (Cont'd)

Traffic Type

Denotes Switched Access capacity types.

Transmission Path

Denotes an electrical path capable of transmitting signals within the range of the service offering, e.g., a voice grade transmission path is capable of transmitting voice frequencies within the approximate range of 300 to 3000 Hz. A transmission path comprises physical or derived channels consisting of any form or configuration of facilities typically used in the telecommunications industry.

Trunk

Denotes a communications path connecting two switching systems in a network, used in the establishment of an end-to-end connection.

Trunk Group

Denotes a set of trunks which are traffic engineered as a unit for the establishment of connections between switching systems in which all of the communications paths are interchangeable.

Trunkside Connection

Denotes the connection of a transmission path to the trunk side of a local exchange switching system.

V and H Coordinates Method

Denotes a method of computing airline miles between two points by utilizing an established formula which is based on the vertical (V) and horizontal (H) coordinates of the two points.

Wire Center

Denotes a building in which one or more central offices, used for the provision of Telephone Exchange Services, are located.

EXHIBIT 4 - COMPETITIVE ACCESS

CenturyTel Broadband Services, Inc.

Supplement No. 1 to
Telephone Pa. P.U.C. Tariff No. 2
Section 3
Original Page 1

COMPETITIVE ACCESS SERVICES TARIFF

3. Carrier Common Line Access Service

3.1 General Description

Carrier Common Line Access Service provides for the use of Company common lines by customers for access to end users to furnish intrastate telecommunications service.

The Company will provide Carrier Common Line Access Service (Carrier Common Line Access) to customers in conjunction with Switched Access Service provided in Section 6 of this Tariff.

3.2 Limitations

3.2.1 Exclusions

Neither a telephone number nor detail billing are provided with Carrier Common Line Access. Additionally, directory listings and intercept arrangements are not included in the rates for Carrier Common Line Access.

3.2.2 Access Groups

All line side connections provided in the same access group will be limited to the same features and operating characteristics.

3.3 Undertaking of the Company

3.3.1 Provision of Service

Where the customer is provided Switched Access Service under other sections of this Tariff, the Company will provide the use of Company common lines by a customer for access to end users at rates as set forth in 3.7, following.

3.3.2 Interstate and Intrastate Use

The Switched Access Service provided by the Company includes the Switched Access Service provided for both interstate and intrastate communications. The Carrier Common Line Access rates as set forth in 3.7, following, apply to interstate Switched Access Service access minutes in accordance with the rate regulations as set forth in 3.6, following, Percent Interstate Use (PIU).

EXHIBIT 4 - COMPETITIVE ACCESS

CenturyTel Broadband Services, Inc.

Supplement No. 1 to
Telephone Pa. P.U.C. Tariff No. 2
Section 3
Original Page 2

COMPETITIVE ACCESS SERVICES TARIFF

3. Carrier Common Line Access Service

3.4 Obligations of the Customer

3.4.1 Switched Access Service Requirement

The Switched Access Service associated with Carrier Common Line Access shall be ordered by the customer under other sections of this Tariff.

3.4.2 Supervision

The customer facilities at the premises of the ordering customer shall provide the necessary on-hook and off-hook supervision.

3.5 Determination of Usage Subject to Carrier Common Line Access Rates

Except as set forth herein, all Switched Access Service provided to the customer will be subject to Carrier Common Line Access rates.

3.5.1 Determination of Jurisdiction

When the customer reports interstate and intrastate use of Switched Access Service, the associated Carrier Common Line Access used by the customer for interstate will be determined as set forth in 3.6.2, following, Percent Interstate Use (PIU).

3.5.2 Switched Access Service Provided in Conjunction with a Commercial Mobile Radio Service Provider

For Switched Access Service provided in conjunction with a Commercial Mobile Radio Service provider, Carrier Common Line Access rates do not apply.

EXHIBIT 4 - COMPETITIVE ACCESS

CenturyTel Broadband Services, Inc.

Supplement No. 1 to
Telephone Pa. P.U.C. Tariff No. 2
Section 3
Original Page 3

COMPETITIVE ACCESS SERVICES TARIFF

3. Carrier Common Line Access Service

3.6 Rate Regulations

3.6.1 Billing of Rates

Carrier Common Line Access rates will be billed to each Switched Access Service provided under this Tariff in accordance with the regulations as set forth in 3.6.2, following, Percent Interstate Use (PIU).

3.6.2 Percent Interstate Use (PIU)

When the customer reports interstate and intrastate use of in-service Switched Access Service, Carrier Common Line Access rates will be billed only to intrastate Switched Access Service access minutes based on the data reported by the customer as set forth in 2.3.9, preceding, except where the Company is billing according to actuals by jurisdiction.

3.6.3 Determination of Rates

After the adjustments as set forth 3.6.2 (PIU), preceding, have been applied, when necessary, to Switched Access Service access minutes, rates for the involvement customer account will be determined as follows:

The terminating access per minute rate applies to all terminating access minutes of use. The originating access per minute rate applies to all originating access minutes of use.

3.7 Rates and Charges

3.7.1 Carrier Common Line

	Rate Per Access Minute
• Originating,	\$0.000000
• Terminating,	0.000000

EXHIBIT 4 - COMPETITIVE ACCESS

CenturyTel Broadband Services, Inc.

Supplement No. 1 to
Telephone Pa. P.U.C. Tariff No. 2
Section 4
Original Page 1

COMPETITIVE ACCESS SERVICES TARIFF

4. Individual Case Basis Arrangements

4.1 Individual Case Basis (ICB) Arrangements

Competitive pricing arrangements at negotiated rates or other terms may be furnished on an Individual Case Basis (ICB) in response to request by customers to the Company, for alternate terms, for proposals or for competitive bids. Service offered under this Tariff provision will be provided to the customer pursuant to contract. Unless otherwise specified, the regulations for such arrangements are in addition to the applicable regulations and prices in other sections of this Tariff. Specialized rates or charges will be made available to similarly situated customers on a non-discriminatory basis.

EXHIBIT 4 - COMPETITIVE ACCESS

CenturyTel Broadband Services, Inc.

Supplement No. 1 to
Telephone Pa. P.U.C. Tariff No. 2
Section 5
Original Page 1

COMPETITIVE ACCESS SERVICES TARIFF

5. Ordering Options for Access Service

5.1 General

This section sets forth the terms, conditions and order related charges for Access Services. These charges are in addition to other applicable charges as set forth in other sections of this Tariff.

An Access Order is an order to provide the customer with any service designated in this Tariff.

5.1.1 ORDERING CONDITIONS

The customer shall provide all information necessary for the Company to provide and bill for the requested service including:

- Customer name and premises address(es).
- Billing name and address (when different from customer name and address).
- Customer contact name(s) and telephone number(s).

5.2 Access Order

5.2.1 Access Order Service Date Intervals

Access Service is provided with one of the following Service Date Intervals:

- Standard Interval
- Negotiated Interval

To the extent the service can be made available with reasonable effort, the Company will provide the service in accordance with the Customer's requested interval, subject to the following conditions:

A. Standard Interval:

- The Standard Interval for Switched Access Service will be 45 days.
- Access Services provided under the Standard Interval will be installed during Company business hours.

EXHIBIT 4 - COMPETITIVE ACCESS

CenturyTel Broadband Services, Inc.

Supplement No. 1 to
Telephone Pa. P.U.C. Tariff No. 2
Section 5
Original Page 2

COMPETITIVE ACCESS SERVICES TARIFF

5. Ordering Options for Access Service

5.2 Access Order

5.2.1 Access Order Service Date Intervals (Cont'd)

B. Negotiated Interval:

The Company will negotiate a service date interval with the Customer on an Individual Case Basis (ICB) when:

- There is no standard interval for the service,
- The Customer requests a service date before or beyond the applicable Standard Interval Service Date,
- The Company determines that the service cannot be installed within the Standard Interval.

The Company will offer a Service Date based on the type and quantity of Access Services the Customer has required. All services for which rates are applied on an Individual Case Basis are provided with a Negotiated Interval.

5.2.2 Cancellation of An Access Order

A customer may cancel an Access Order upon written notice at least five business days prior to the estimated availability date. The Company may invoice the customer for costs incurred, not to exceed the nonrecurring charges associated with the order.

EXHIBIT 4 - COMPETITIVE ACCESS

CenturyTel Broadband Services, Inc.

Supplement No. 1 to
Telephone Pa. P.U.C. Tariff No. 2
Section 5
Original Page 3

COMPETITIVE ACCESS SERVICES TARIFF

5. Ordering Options for Access Service

5.2 Access Order (Cont'd)

5.2.3 Minimum Period

- A. The minimum period for which service is provided and for which charges are applicable is one month.
- B. When Access Service is disconnected prior to the expiration of the minimum period, charges are applicable for the balance of the minimum period. The Minimum Period Charge for monthly billed services will be determined as follows:
 - The charge for a month or fraction thereof is the applicable minimum monthly charge for the capacity made available to the Customer.
 - All applicable Non-Recurring Charges for the service will be billed in addition to the Minimum Period Charge.

5.2.4 Discontinuance of Service

A customer may discontinue an Access Service at any time. The Company requires two business days notice to discontinue an Access Service. The notice can be written or verbal; however, a verbal notice must be followed by a written confirmation within ten days. The notice period will begin at the time of a verbal notice. If there is no verbal notice, the notice period begins at the time the written request is received.

EXHIBIT 4 - COMPETITIVE ACCESS

CenturyTel Broadband Services, Inc.

Supplement No. 1 to
Telephone Pa. P.U.C. Tariff No. 2
Section 6
Original Page 1

COMPETITIVE ACCESS SERVICES TARIFF

6. Switched Access Service

6.1 General

Feature Group D (FGD) Switched Access Service, which is available to customers for their use in furnishing their services to end users, provides a two-point electrical communications path between a customer's premises and an end user's premises via a LEC tandem. It provides for the use of terminating, switching, transport facilities and common subscriber plant of the Company.

Switched Access Service provides for the ability to originate calls from an end user's premises to a customer's premises, and to terminate calls from a customer's premises to an end user's premises in the LATA where it is provided.

Rates and charges for Switched Access Service are set forth in Section 6.8, following. The application of rates for Switched Access Service is described in 6.7, following.

As established in the 8YY Access Charge Reform (FCC 20-143), existing tandem switching charges and transport charges for originating 8YY traffic are eliminated and a single joint tandem switched access service rate element for 8YY originating access service is established as 8YY Joint Tandem Switched Transport.

EXHIBIT 4 - COMPETITIVE ACCESS

CenturyTel Broadband Services, Inc.

Supplement No. 1 to
Telephone Pa. P.U.C. Tariff No. 2
Section 6
Original Page 2

COMPETITIVE ACCESS SERVICES TARIFF

6. Switched Access Service

6.1 General (Cont'd)

6.1.1 Switched Access Service Arrangements and Manner of Provision

- A. FGD is furnished on a per trunk basis.
- B. Trunks are differentiated by type and directionality of traffic carried over a Switched Access Service arrangement. Differentiation among traffic types is necessary for the Company to design Switched Access Service properly to meet the traffic carrying capacity requirement of the customer.
- C. There are two major traffic types:
 - 1. Originating traffic type represents access capacity within a LATA for carrying traffic from the Company's end user to the customer.
 - 2. Terminating traffic type represents access capacity within a LATA for carrying traffic from the customer to the Company's end user.

When ordering capacity for Trunkside Switched Access, the customer must, at a minimum, specify such access capacity in terms of Originating and/or Terminating traffic type.

EXHIBIT 4 - COMPETITIVE ACCESS

CenturyTel Broadband Services, Inc.

Supplement No. 1 to
Telephone Pa. P.U.C. Tariff No. 2
Section 6
Original Page 3

COMPETITIVE ACCESS SERVICES TARIFF

6. Switched Access Service

6.1 General (Cont'd)

6.1.2 Rate Categories

The three rate categories which apply to the Company's Switched Access Service:

- Switched Transport (described in 6.1.2.A., following).
- Local Switching (described in 6.1.2.B., following).
- Common Line (described in Section 3, preceding).

The following diagram, in combination with the billing described in Section 2.4.8, depict a possible serving arrangement and components of Switched Access Service and the manner in which the components are combined to provide a complete access service. LEC Tandem Routing is used when the customer is indirectly connected to the Company's end office via a LEC tandem. The following diagram is not intended to depict all serving arrangements available.

EXHIBIT 4 - COMPETITIVE ACCESS

CenturyTel Broadband Services, Inc.

Supplement No. 1 to
Telephone Pa. P.U.C. Tariff No. 2
Section 6
Original Page 4

COMPETITIVE ACCESS SERVICES TARIFF

6. Switched Access Service

6.1 General

6.1.2 Rate Categories (Cont'd)

EXAMPLE 1

Switched Access Service Ordered
with LEC Tandem Routing

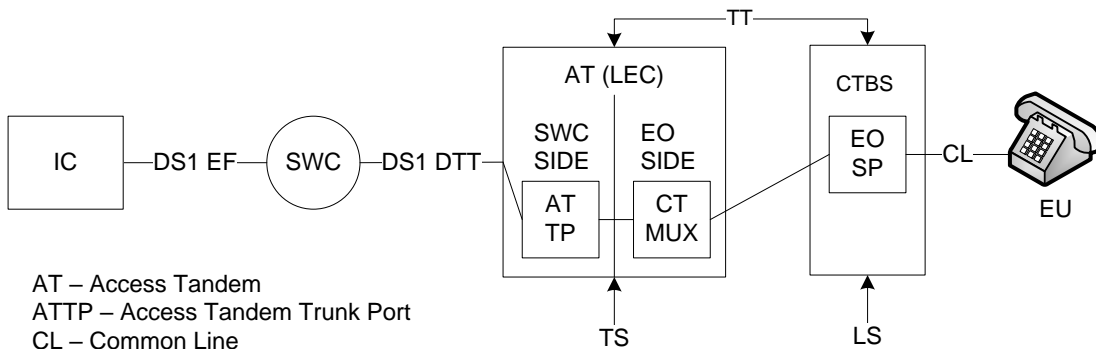

- AT – Access Tandem
- ATTP – Access Tandem Trunk Port
- CL – Common Line
- CT MUX – Common Transport Multiplexer
- DTT – Direct Trunked Transport
- EF – Entrance Facility
- EO – End Office
- EO SP – End Office Shared Port
- EU – End User
- IC – Interexchange Carrier
- LEC – Local Exchange Carrier
- LS – Local Switching
- MUX – Multiplexer
- SWC – Serving Wire Center
- TS – Tandem Switching
- TT – Tandem Transmission

EXHIBIT 4 - COMPETITIVE ACCESS

CenturyTel Broadband Services, Inc.

Supplement No. 1 to
Telephone Pa. P.U.C. Tariff No. 2
Section 6
Original Page 5

COMPETITIVE ACCESS SERVICES TARIFF

6. Switched Access Service

6.1 General

6.1.2 Rate Categories (Cont'd)

A. Switched Transport

1. General Description

The Switched Transport rate category provides the transmission facilities between the customer's premises and the end office switch(s) where the customer's traffic is switched to originate or terminate its communications. The Switched Transport rate category provides the transmission facilities between the customer's premises and a LEC tandem.

Switched Transport is a two-way voice-frequency transmission path composed of an Entrance Facility (EF) and a Direct-Trunked Transport (DTT) facility to the tandem and Tandem-Switched Transport (TST) from the tandem to the subtending end offices. The transmission path permits the transport of calls in the originating direction (from the end user's end office switch to the customer's premises) and in the terminating direction (from the customer's premises to the end office switch), but not simultaneously. The voice-frequency transmission path may be comprised of any form or configuration of plant capable of and typically used in the telecommunications industry for the transmission of voice and associated telephone signals within the frequency bandwidth of approximately 300 to 3000 Hz.

Switched Transport is provided at the rates and charges set forth in Section 6.8, following. The application of these rates with respect to the different types of service is as set forth in 6.7.1, following.

Switched Access is ordered under the access order provisions as set forth in Section 5, preceding. Design and traffic routing of Switched Access Service is described in 6.5.2, following.

EXHIBIT 4 - COMPETITIVE ACCESS

CenturyTel Broadband Services, Inc.

Supplement No. 1 to
Telephone Pa. P.U.C. Tariff No. 2
Section 6
Original Page 6

COMPETITIVE ACCESS SERVICES TARIFF

6. Switched Access Service

6.1 General

6.1.2 Rate Categories

A. Switched Transport (Cont'd)

2. Switched Transport TST Rate Category

TST provides the transmission facilities between a LEC tandem and the Company's end offices subtending that tandem. For TST, the Company will determine the type of facilities to the end office(s) based on the customer's order for service on a per-trunk basis.

The TST rate category is composed of the Tandem Transmission rate element, a fixed per-MOU rate and per-mile/per-MOU rate. The fixed rate provides for the circuit equipment at the end of the interoffice transmission paths. The per-mile rate provides for the transmission facilities, including intermediate transmission circuit equipment between the end points of the interoffice circuit. For purposes of determining the per-mile rate, mileage will be measured as airline mileage using the V & H coordinates method. Mileage measurement rules are set forth in 6.7.7, and rates and charges are set forth in Section 6.8, following.

3. Tandem Switching

Tandem Switching is per-MOU rate assessed for utilization tandem switching functions when tandem routing is requested for trunkside services.

4. Common Transport Multiplexing

Common Transport multiplexing equipment is utilized in the end office side of the access tandem when common transport is provided between the access tandem and the subtending end offices. This rate is assessed on the per-MOU basis.

EXHIBIT 4 - COMPETITIVE ACCESS

CenturyTel Broadband Services, Inc.

Supplement No. 1 to
Telephone Pa. P.U.C. Tariff No. 2
Section 6
Original Page 7

COMPETITIVE ACCESS SERVICES TARIFF

6. Switched Access Service

6.1 General

6.1.2 Rate Categories (Cont'd)

B. Local Switching

The Local Switching rate category provides the local end office switching, end user line termination and intercept functions necessary to complete the transmission of Switched Access Communications to and from the end users served by the local end office. The Local Switching rate categories are described following. Local Switching rates are set forth in Section 6.8. The application of these rates with respect to the different types of service are set forth in 6.7.1, following.

1. Local End Office Switching Functions

a. Common Switching

Common Switching provides the local end office switching functions. Included as part of Common Switching are optional features which the customer can order. These optional features are described in 6.3, following.

b. Transport Termination

Transport Termination provides for the lineside or trunkside arrangements which terminate the Switched Transport facilities. The number of Transport Terminations will be determined by the Company as set forth in 6.5.5, following.

EXHIBIT 4 - COMPETITIVE ACCESS

CenturyTel Broadband Services, Inc.

Supplement No. 1 to
Telephone Pa. P.U.C. Tariff No. 2
Section 6
Original Page 8

COMPETITIVE ACCESS SERVICES TARIFF

6. Switched Access Service

6.1 General

6.1.2 Rate Categories

B. Local Switching (Cont'd)

2. Local Switching Rate Categories

- a. Local Switching per MOU rate elements applies to originating and terminating minutes.
- b. End Office Shared Port

The End Office Shared Port rate provides for the termination of Tandem Transmission trunks in the shared end office ports. The End Office Shared Port is assessed on a per MOU basis to all trunkside originating and terminating access minutes utilizing tandem routing to an end office.

- c. Toll Free Database Access Service

Toll Free Data Base Access Service is a service offering utilizing originating trunk side Switched Access Service. The service provides for the forwarding of end user dialed Toll Free calls to a Company Service Switching Point which will initiate a query to the data base to perform the Customer identification and delivery function. The call is forwarded to the appropriate Customer based on the dialed Toll Free number. Toll Free Data Base Access Service is comprised of the following elements:

- Basic Query - Customer Identification Charge

The Toll Free Data Base Access Service Basic Query Charge applies for the identification of the appropriate Customer and delivery of the dialed 800 ten digit number. The charge is assessed to the Customer on a per query basis and may include an area of service which may range from a single NPA/NXX to an area consisting of all LATAs and NPAs. The Toll Free Basic Query Charge is set forth in 6.8.1.

- Complex Query – Vertical Feature Charge

The Toll Free Data Base Access Service Complex Query Charge provides feature functionality in addition to the basic query. The feature package may include various destination options such as POTS Translation, carrier selection, time of day routing, day of week routing, specific date routing, geographic routing, routing based on percent of allocation, and emergency routing profiles. The Toll Free Complex Query Charge is set forth in 6.8.1.

EXHIBIT 4 - COMPETITIVE ACCESS

CenturyTel Broadband Services, Inc.

Supplement No. 1 to
Telephone Pa. P.U.C. Tariff No. 2
Section 6
Original Page 9

COMPETITIVE ACCESS SERVICES TARIFF

6. Switched Access Service

6.1 General (Cont'd)

6.1.3 Acceptance Testing

At no additional charge, the Company will perform acceptance testing at the time of installation. Acceptance tests will be performed to insure that the service is operational and meets applicable technical parameters. The Company will, at the customer's request, schedule a mutually agreeable time to perform acceptance testing in cooperation with the customer. If the customer is unable to participate in the acceptance testing, or if the customer requests that service installation be completed, without their presence, the service is assumed to be accepted (i.e., blind acceptance) by the customer.

6.1.4 Ordering Options and Conditions

Switched Access Service is ordered under the Access Order provisions set forth in Section 5, preceding.

EXHIBIT 4 - COMPETITIVE ACCESS

CenturyTel Broadband Services, Inc.

Supplement No. 1 to
Telephone Pa. P.U.C. Tariff No. 2
Section 6
Original Page 10

COMPETITIVE ACCESS SERVICES TARIFF

6. Switched Access Service

6.2 Provision and Description of Switched Access Service

6.2.1 Provision of Switched Access Service

- A. Switched Access Service is provided in different serving arrangements. The provision of each type of Switched Access Service requires Switched Transport facilities.
- B. Serving arrangements are arranged for either originating, terminating or two-way calling, based on the capacity the customer ordered. Originating calling permits the delivery of calls from the Company's Telephone Exchange Service locations to the customer's premises. Terminating calling permits the delivery of calls from the customer's premises to the Company's Telephone Exchange Service locations. Two-way calling permits the delivery of calls in both directions, but not simultaneously. The Company will determine the type of calling to be provided unless the customer requests that a different type of directional calling is to be provided. In such cases, the Company will work cooperatively with the customer to determine the directionality.
- C. Following are detailed descriptions of each of the available Switched Access Services. Each service is described in terms of its specific physical characteristics and calling patterns, the transport provisioning, the transmission specifications with which it is provided, the optional features available for use with it and the standard testing capabilities.
- D. Availability and wire center information are as set forth in the National Exchange Carrier Association (N.E.C.A.) Tariff F.C.C No. 4.

EXHIBIT 4 - COMPETITIVE ACCESS

CenturyTel Broadband Services, Inc.

Supplement No. 1 to
Telephone Pa. P.U.C. Tariff No. 2
Section 6
Original Page 11

COMPETITIVE ACCESS SERVICES TARIFF

6. Switched Access Service

6.2 Provision and Description of Switched Access Service (Cont'd)

6.2.2 Description of Feature Group D (FGD)

- A. FGD is provided at Company designated end office switches or at tandem switches.
- B. FGD provides a trunkside termination through the use of tandem switch trunk equipment.
- C. When Feature Group D is switched through an access tandem, the Company's Switched Transport configuration is composed of TST from the access tandem to the end offices subtending the tandem.
- D. The number dialed by the customer's end user shall be a seven or ten digit number for calls in the North American Numbering Plan (NANP). The form of the numbers dialed by the end user is 1 + NPA + NXX-XXXX.
- E. FGD is provided with Transmission Type A1 parameters that are delineated in industry standards and Technical Publications.
- F. FGD is provided, in the terminating direction where equipment is available, with ten digit access to milliwatt (102 type) test line.

EXHIBIT 4 - COMPETITIVE ACCESS

CenturyTel Broadband Services, Inc.

Supplement No. 1 to
Telephone Pa. P.U.C. Tariff No. 2
Section 6
Original Page 12

COMPETITIVE ACCESS SERVICES TARIFF

6. Switched Access Service

6.3 Common Switching Optional Features

Following are descriptions of the various optional features that are available in lieu of, or in addition to, the standard features provided with the Switched Access Services. They are provided as Common Switching options.

6.3.1 Automatic Number Identification (ANI)

- A. This option provides the automatic transmission of a three or ten digit number and information digits to the customer's premises for calls originating in the LATA, to identify the calling station. The three or ten digit numbers will contain the following information: three digit, NPA only and ten digit, NPA+NXX-XXXX. The ANI feature is an end office software function which is associated on a call-by-call basis with trunk groups between a customer's premises routed through an access tandem.
- B. Where ANI cannot be provided, information digits will be provided to the customer.

EXHIBIT 4 - COMPETITIVE ACCESS

CenturyTel Broadband Services, Inc.

Supplement No. 1 to
Telephone Pa. P.U.C. Tariff No. 2
Section 6
Original Page 13

COMPETITIVE ACCESS SERVICES TARIFF

6. Switched Access Service

6.3 Common Switching Optional Features

6.3.1 Automatic Number Identification (ANI) (Cont'd)

- C. ANI information and Charge Number information are provided based on the following requirements:
1. The telephone number and billing information may be used for billing and collection, routing, screening, and completion of the originating subscriber's call or transaction, or for services directly related to the originating subscriber's call or transaction;
 2. The ANI information shall not be reused or resold without first (A) notifying the originating subscriber and (B) obtaining the affirmative consent of such subscriber for such reuse or resale; and
 3. ANI information shall not be disclosed, except as permitted by (1) and (2), above, for any purpose other than performing the services or transactions that are the subject of the originating subscriber's call, (ii) ensuring network performance security, and the effectiveness of call delivery, (iii) compiling, using and disclosing aggregate information, and (iv) complying with applicable law or legal process.

6.3.2 Service Class Routing

This option provides the capability of directing originating traffic from an end office to a tandem trunk group to a customer designated premises, based on service access code (e.g., 8XX). It is provided in suitably equipped tandem switches based on technical limitations.

6.4 Transmission Specifications

Each Switched Access Service transmission path is provided with standard transmission parameter limits for service routed to a tandem.

EXHIBIT 4 - COMPETITIVE ACCESS

CenturyTel Broadband Services, Inc.

Supplement No. 1 to
Telephone Pa. P.U.C. Tariff No. 2
Section 6
Original Page 14

COMPETITIVE ACCESS SERVICES TARIFF

6. Switched Access Service

6.5 Obligations of The Company

In addition to the obligations of the Company set forth in Section 2, preceding, the Company has certain other obligations pertaining only to the provision of Switched Access Service. These obligations are as follows:

6.5.1 Network Management

The Company will administer its network to ensure the provision of acceptable service levels to all telecommunications users of the Company's network services.

Generally, service levels are considered acceptable only when Company end users and customers are able to establish connections with little or no delay encountered within the Company network. The Company maintains the right to apply protective controls, i.e., those actions, such as call gapping, which selectively cancel the completion of traffic, over any traffic carried over its network, including that associated with a customer's Switched Access Service. Generally, such protective measures would only be taken as a result of occurrences such as failure or overload of Company or customer facilities, natural disasters, mass calling or national security demands. In the event that the protective controls applied by the Company result in the complete loss of service by the customer, the customer will be granted a Credit Allowance for Service Interruption as set forth in 2.4.5.B., preceding.

6.5.2 Design and Traffic Routing of Switched Access Service

When ordering Switched Access Service, the customer shall specify on the order for service the number of trunks and the desired directionality (i.e., one-way, two-way). When the customer orders facilities, routing, directionality or optional features different from that determined to be available by the Company, the Company will work cooperatively with the customer in determining an acceptable configuration based on available facilities, equipment and the Company routing plans. Rates and charges for Switched Transport, as set forth in Section 6.8, following, will be applied based on the transport provisioned at the time the order is completed.

EXHIBIT 4 - COMPETITIVE ACCESS

CenturyTel Broadband Services, Inc.

Supplement No. 1 to
Telephone Pa. P.U.C. Tariff No. 2
Section 6
Original Page 15

COMPETITIVE ACCESS SERVICES TARIFF

6. Switched Access Service

6.5 Obligations of The Company (Cont'd)

6.5.3 Provision of Service Performance Data

Subject to availability, end-to-end service performance data available to the Company through its own service evaluation routines, may also be made available to the customer based on previously arranged intervals and format. These data provide information on overall end-to-end call completion and non-completion performance, e.g., customer equipment blockage, failure results and transmission performance. These data do not include service performance data which are provided under other Tariff sections, e.g., testing service results. If data are to be provided in other than paper format, the charges for such exchange will be determined on an individual case basis.

6.5.4 Trunk Group Measurement Reports

Subject to availability, the Company will make available trunk group data in the form of usage in CCS, peg count and overflow, to the customer based on previously agreed to intervals.

6.5.5 Determination of Number of End Office Transport Terminations

For digital entry switches, an equivalent termination will be provided for each Feature Group or trunk requested

EXHIBIT 4 - COMPETITIVE ACCESS

CenturyTel Broadband Services, Inc.

Supplement No. 1 to
Telephone Pa. P.U.C. Tariff No. 2
Section 6
Original Page 16

COMPETITIVE ACCESS SERVICES TARIFF

6. Switched Access Service

6.5 Obligations of The Company (Cont'd)

6.5.6 Design Blocking Probability

The Company will perform routine measurement functions for the trunks ordered in accordance with Company design blocking criteria to assure that an adequate number of trunks are in service. The Company will recommend that additional trunks be ordered by the customer when additional trunks are required to reduce the measured blocking to the designed blocking level. Where design blocking criteria apply, the design blocking objective is assumed to have been met if the routine measurements show that the measured blocking does not exceed the thresholds listed in the following table.

For transmission paths carrying first-routed traffic between an end office and a customer's premises via a tandem, the measured blocking thresholds are as follows:

Number of Transmission Paths Per Trunk Group	Measured Blocking Thresholds in the Time Consistent Busy Hour for the Number of Measurements Per Trunk Group			
	15-20 Measure- ments	11-14 Measure- ments	7-10 Measure- ments	3-6 Measure- ments
2	.045	.055	.060	.095
3	.035	.040	.045	.060
4	.035	.040	.045	.055
5-6	.025	.035	.040	.045
7 or more	.020	.025	.030	.040

EXHIBIT 4 - COMPETITIVE ACCESS

CenturyTel Broadband Services, Inc.

Supplement No. 1 to
Telephone Pa. P.U.C. Tariff No. 2
Section 6
Original Page 17

COMPETITIVE ACCESS SERVICES TARIFF

6. Switched Access Service

6.6 Obligations of The Customer

In addition to the obligations of the customer set forth in Section 2, preceding, the customer has certain specific obligations pertaining to the use of Switched Access Service. These obligations are as follows:

6.6.1 Ordering Requirements

When ordering Switched Access Service, the customer shall specify on the order for service, the desired interoffice transport, the number of trunks to be provisioned at the tandem and the desired directionality.

6.6.2 Report Requirements

Customers are responsible for providing the following reports to the Company, when applicable.

A. Jurisdictional Reports

When a customer orders Switched Access Service for both interstate and intrastate use, the customer is responsible for providing reports as set forth in 2.3.9, preceding. Charges will be apportioned in accordance with those reports. The method to be used for determining the intrastate charges is set forth in 2.3.10, preceding.

B. Code Screening Reports

When a customer orders Service Class Routing, it must report the number of trunks and/or the appropriate codes to be instituted in each tandem switch, for each of the arrangements ordered.

EXHIBIT 4 - COMPETITIVE ACCESS

CenturyTel Broadband Services, Inc.

Supplement No. 1 to
Telephone Pa. P.U.C. Tariff No. 2
Section 6
Original Page 18

COMPETITIVE ACCESS SERVICES TARIFF

6. Switched Access Service

6.6 Obligations of The Customer (Cont'd)

6.6.3 Trunk Group Measurement Reports

With the agreement of the customer, trunk group data in the form of usage in one hundred call seconds (CCS), peg count and overflow for its end of all access trunk groups, where technologically feasible, will be made available to the Company. These data will be used to monitor trunk group utilization and service performance and will be based on previously arranged intervals and format.

6.6.4 Design of Switched Access Services

When a customer orders Switched Access Service on a per-facility and/or per-trunk basis, it is the customer's responsibility to assure that sufficient access services have been ordered to handle its traffic.

6.7 Rate Terms and Conditions

This section contains the specific terms and conditions governing the rates and charges that apply for Switched Access Service.

6.7.1 Description and Application of Rates and Charges

There are two types of rates and charges that apply to Switched Access Service with LEC Tandem Routing. These are usage rates and nonrecurring charges. These rates and charges are applied differently to the various rate elements as set forth, following. Rates are set forth in Section 6.8, Rates and Charges.

A. Usage Rates

Usage rates are rates that apply only when a specific rate element is used. These are applied on a per access minute, a per call or per query basis. Usage rates are accumulated over a monthly period.

EXHIBIT 4 - COMPETITIVE ACCESS

CenturyTel Broadband Services, Inc.

Supplement No. 1 to
Telephone Pa. P.U.C. Tariff No. 2
Section 6
Original Page 19

COMPETITIVE ACCESS SERVICES TARIFF

6. Switched Access Service

6.7 Rate Terms and Conditions

6.7.1 Description and Application of Rates and Charges (Cont'd)

B. Nonrecurring Charges

Nonrecurring charges are one-time charges that apply for a specific work activity (i.e., installation or change to an existing service). The types of nonrecurring charges that apply for Switched Access Service are: installation of service, installation of optional features and service rearrangements. These charges are set forth in Section 6.8, following.

1. Installation of Service

Nonrecurring charges apply for the installation of the individual Feature Group trunk.

- a. Switched Access Service is ordered on a trunk basis, the nonrecurring charge is applied per trunk. If a customer orders multiple trunks on the same Access Order, the first trunk is assessed the "first" installation charge and each additional trunk is assessed the "each additional" installation charge per Access Order.
- b. Nonrecurring charges for FGD Switched Access Service include one Carrier Identification Code (CIC) on an initial Access Order. The CIC is a uniform numeric code that identifies the customer associated with the Switched Access Service. The customer of the initial CIC is the customer of record for the Switched Access Service. When a customer requests two or more CICs on an initial Access Order, each additional CIC (i.e., two or more) is considered to be a service rearrangement as set forth in 3., following.

EXHIBIT 4 - COMPETITIVE ACCESS

CenturyTel Broadband Services, Inc.

Supplement No. 1 to
Telephone Pa. P.U.C. Tariff No. 2
Section 6
Original Page 20

COMPETITIVE ACCESS SERVICES TARIFF

6. Switched Access Service

- 6.7 Rate Terms and Conditions
- 6.7.1 Description and Application of Rates and Charges
- B. Nonrecurring Charges (Cont'd)

- 2. Installation of Optional Features

Nonrecurring charges may apply for the installation of some of the optional features available with Switched Access Service. The charge applies whether the feature is installed coincident with the initial installation of service or at any time subsequent to the initial installation of service.

- 3. Service Rearrangements

Service rearrangements are changes to existing services installed which do not result in either a change in the minimum period requirements as set forth in 5.2.3, preceding, or a change in the physical location of the POT at a customer's premises or a customer's end user's premises. Changes which result in the establishment of new minimum period obligations are treated as disconnects and starts. Changes in the physical location of the POT are treated as moves and are described and charged for as set forth in 6.7.4, following.

The charge to the customer for the service rearrangement is dependent on whether the change is administrative only in nature or involves an actual technical and/or physical change to the service.

EXHIBIT 4 - COMPETITIVE ACCESS

CenturyTel Broadband Services, Inc.

Supplement No. 1 to
Telephone Pa. P.U.C. Tariff No. 2
Section 6
Original Page 21

COMPETITIVE ACCESS SERVICES TARIFF

6. Switched Access Service

6.7 Rate Terms and Conditions

6.7.1 Description and Application of Rates and Charges

B. Nonrecurring Charges

3. Service Rearrangements (Cont'd)

- a. Administrative changes will be made without charge(s) to the customer. Administrative changes are as follows:
 - Change of customer name, (i.e., the customer of record does not change, but rather the customer of record changes its name, e.g., XYZ Company to XYZ Communications),
 - Change of customer name as the result of a transfer of use of service as set forth in 2.1.2, preceding,
 - Change of customer or customer's end user's premises address when the change of address is not a result of a physical relocation of equipment,
 - Change in billing data (name, address or contact name or telephone number),
 - Change of agency authorization,
 - Change of customer circuit identification,
 - Change of billing account number,
 - Change of customer test line number,
 - Change of customer or customer's end user's contact name or telephone number, and
 - Change of jurisdiction.

EXHIBIT 4 - COMPETITIVE ACCESS

CenturyTel Broadband Services, Inc.

Supplement No. 1 to
Telephone Pa. P.U.C. Tariff No. 2
Section 6
Original Page 22

COMPETITIVE ACCESS SERVICES TARIFF

6. Switched Access Service

6.7 Rate Terms and Conditions

6.7.1 Description and Application of Rates and Charges

B. Nonrecurring Charges

3. Service Rearrangements (Cont'd)

b. All other service rearrangements will be charged for as follows:

- If the change involves the addition of or a modification to an optional feature which has a separate nonrecurring charge, that nonrecurring charge will apply.
- If, due to an office replacement, a customer requests conversion from one-way to two-way trunks, and the request is made six months in advance of the office replacement due date, the nonrecurring charges will not apply.
- For all other changes, including the addition of, or modifications to optional features without separate nonrecurring charges, a charge equal to one-half the Switched Transport per trunk nonrecurring (i.e., installation) charge will apply. This one-half nonrecurring charge is assessed the "first" installation charge for the first trunk and each additional trunk is assessed the "each additional" installation charge, per Access Order. If two or more optional features and changes are ordered on the same Access Order, the optional feature or change requiring the lowest level of work activity will apply. A maximum one-half nonrecurring charge will apply per Access Order for service rearrangements.
- If a feature is not required on each trunk, but rather for an entire hunt or trunk group, only one such charge will apply (i.e., it will not apply per trunk). This one-half nonrecurring charge is assessed the "first" installation charge for the first hunt group, trunk group or end office. Each additional hunt group, trunk group or end office is assessed the "each additional" installation charge, per Access Order. Nonrecurring charges for service rearrangements are specified in Section 6.8, following.

EXHIBIT 4 - COMPETITIVE ACCESS

CenturyTel Broadband Services, Inc.

Supplement No. 1 to
Telephone Pa. P.U.C. Tariff No. 2
Section 6
Original Page 23

COMPETITIVE ACCESS SERVICES TARIFF

6. Switched Access Service

6.7 Rate Terms and Conditions

6.7.1 Description and Application of Rates and Charges

B. Nonrecurring Charges

3. Service Rearrangements

b. All other service rearrangements will be charged for as follows: (Cont'd)

- Nonrecurring charges for additional (i.e., two or more) CICs are determined based on whether the FGD trunk(s) or trunk group(s) are new or existing, and the level of work activity (i.e., trunk, trunk group, and/or tandem).
 - When the trunk or trunk group is new, one CIC is included in the nonrecurring charges for the initial Access Order. Each additional CIC requested on the same Access Order is assessed one-half the "each additional" installation charge assessed. In addition, the charge is based on the lowest level of work, per Access Order, per LATA. The additional (i.e., two or more) CIC service rearrangement charge is in addition to Installation Charge(s) for the trunk(s).
 - When the FGD trunk group is existing service and the customer is requesting additional CICs on an existing tandem-routed trunk group, the customer is charged one-half the "first" installation charge. Each "additional" CIC after the "first additional" CIC on the same Access Order is charged one-half the "each additional" installation charge, per LATA.

C. Application of Rates

Rate categories and the application of rates are described in 6.1.2. Rates and charges are set forth in Section 6.8, following.

EXHIBIT 4 - COMPETITIVE ACCESS

CenturyTel Broadband Services, Inc.

Supplement No. 1 to
Telephone Pa. P.U.C. Tariff No. 2
Section 6
Original Page 24

COMPETITIVE ACCESS SERVICES TARIFF

6. Switched Access Service

6.7 Rate Terms and Conditions (Cont'd)

6.7.2 Minimum Periods

Minimum periods for Switched Access Service are described in 5.2.3, preceding.

6.7.3 Minimum Monthly Charge

Switched Access Service is subject to a minimum monthly charge. The minimum charge applies for the total capacity provided. The minimum monthly charge for usage rated elements is the sum of the charges set forth in Section 6.8, following, for the measured or assumed usage for the month.

EXHIBIT 4 - COMPETITIVE ACCESS

CenturyTel Broadband Services, Inc.

Supplement No. 1 to
Telephone Pa. P.U.C. Tariff No. 2
Section 6
Original Page 25

COMPETITIVE ACCESS SERVICES TARIFF

6. Switched Access Service

6.7 Rate Terms and Conditions (Cont'd)

6.7.4 Moves

New minimum period requirements will be established for moved or reconfigured services. Any changes to the existing Switched Access facilities, trunks and optional features as they exist at the current location, excluding a change in Circuit Facility Assignment (CFA), made in conjunction with a move or reconfiguration, will be treated as a discontinuance and a start of new service and all associated nonrecurring installation charges will apply. The addition of lines and trunks made in conjunction with a move or reconfiguration will be treated as a start of new service and all associated nonrecurring installation charges and new minimum period requirements will apply. The customer will also remain responsible for satisfying all outstanding minimum period charges for any disconnected service as the result of a move or reconfiguration.

6.7.5 Measuring Access Minutes

Customer traffic to or from Company end office switches will be measured (i.e., recorded) by the Company at end office switches. The measured minutes are the chargeable access minutes.

EXHIBIT 4 - COMPETITIVE ACCESS

CenturyTel Broadband Services, Inc.

Supplement No. 1 to
Telephone Pa. P.U.C. Tariff No. 2
Section 6
Original Page 26

COMPETITIVE ACCESS SERVICES TARIFF

6. Switched Access Service

6.7 Rate Terms and Conditions (Cont'd)

6.7.6 Feature Group D Usage Measurement

FGD access minutes or fractions thereof, the exact value of the fraction being a function of the switch technology where the measurement is made, are accumulated over the billing period for each tandem, and are then rounded up to the nearest access minute for each tandem.

The following assumed minutes are used in the computation of Switched Access Service charges.

A. Originating Usage Measurement

Out of Band SS7 Signaling

- For originating calls over FGD, usage measurement begins when the FGD entry switch receives an Exit Message (EXM).
- The measurement of originating call usage over FGD with SS7 out of band signaling ends when a Release Message is sent or received by the originating end user's end office, whichever occurs first.

B. Terminating Usage Measurement

- For terminating calls over FGD, the measurement of access minutes begins when the terminating FGD entry switch receives answer supervision from the Company end office, indicating the terminating end user has answered.
- The measurement of terminating call usage over FGD ends when the terminating FGD entry switch receives disconnect supervision from the Company end office, indicating the terminating end user has disconnected, or the customer's POT, whichever is recognized first by the entry switch.

EXHIBIT 4 - COMPETITIVE ACCESS

CenturyTel Broadband Services, Inc.

Supplement No. 1 to
Telephone Pa. P.U.C. Tariff No. 2
Section 6
Original Page 27

COMPETITIVE ACCESS SERVICES TARIFF

6. Switched Access Service

6.7 Rate Terms and Conditions (Cont'd)

6.7.7 Mileage Measurement

The mileage to be used to determine the Switched Transport rate for traffic is calculated on the airline distance between the end office switch, where the call originates or terminates and the access tandem. The V&H coordinates method is used to determine mileage. This method is set forth in the National Exchange Carrier Association, Inc. Tariff F.C.C. No. 4 for Wire Center Information (V & H coordinates).

Mileage rates are shown in Section 6.8, following. If the V & H calculation results in a fraction of a mile, always round up to the next whole mile for rate application.

EXHIBIT 4 - COMPETITIVE ACCESS

CenturyTel Broadband Services, Inc.

Supplement No. 1 to
Telephone Pa. P.U.C. Tariff No. 2
Section 6
Original Page 28

COMPETITIVE ACCESS SERVICES TARIFF

6. Switched Access Service

6.8 Rates and Charges

6.8.1 Switched Recurring Rates

A. Tandem-Switched Transport Usage Rates

	Rate Per Access Minute	
	Fixed	Per Mile
• Tandem Transmission		
Facility Termination		
- Originating – Non-Toll Free *	\$0.000000	\$0.000002
- Terminating – Tandem 3rd Party	\$0.000000	\$0.000002
- Terminating – Tandem End Office	\$0.000000	\$0.000000
	Rate Per Access Minute	
• Tandem Switching Charge		
- Originating – Non-Toll Free *		\$0.001574
- Terminating – Tandem 3rd Party		\$0.001574
- Terminating – Tandem End Office		\$0.000000
• Common Transport Multiplexing		
- Originating – Non-Toll Free *		\$0.000000
- Terminating – Tandem 3rd Party		\$0.000000
- Terminating – Tandem End Office		\$0.000000

* Pursuant to FCC 20-143, separate rate elements for Toll Free and Non-Toll Free originating transport services were established. The Originating Toll Free rate element for combined transport services is displayed as 8YY Joint Tandem Switched Transport.

EXHIBIT 4 - COMPETITIVE ACCESS

CenturyTel Broadband Services, Inc.

Supplement No. 1 to
Telephone Pa. P.U.C. Tariff No. 2
Section 6
Original Page 29

COMPETITIVE ACCESS SERVICES TARIFF

6. Switched Access Service

6.8 Rates and Charges

6.8.1 Switched Recurring Rates

A. Tandem-Switched Transport Usage Rates

Rate Per Access Minute

- 8YY Joint Tandem Switched Transport
 - Originating –Toll Free * \$0.001

* Pursuant to FCC 20-143, separate rate elements for Toll Free and Non-Toll Free originating transport services were established. The Originating Toll Free rate element for combined transport services is displayed as 8YY Joint Tandem Switched Transport.

EXHIBIT 4 - COMPETITIVE ACCESS

CenturyTel Broadband Services, Inc.

Supplement No. 1 to
Telephone Pa. P.U.C. Tariff No. 2
Section 6
Original Page 30

COMPETITIVE ACCESS SERVICES TARIFF

6. Switched Access Service

6.8 Rates and Charges

6.8.1 Switched Recurring Rates

B. Local Switching

	Rate Per Access Minute
• Local End Office Switching:	
- Originating Toll Free	\$0.002406
- Originating Non-Toll Free	\$0.002406
- Terminating	\$0.000000
• End Office Shared Port	
- Originating Toll Free	\$0.001688
- Originating Non-Toll Free	\$0.001688
- Terminating	\$0.000000
	Rate Per Call/Query
• Toll Free Data Base Access Service	
- Basic Query	\$0.004248
- Complex Query	\$0.000000

EXHIBIT 4 - COMPETITIVE ACCESS

CenturyTel Broadband Services, Inc.

Supplement No. 1 to
Telephone Pa. P.U.C. Tariff No. 2
Section 6
Original Page 31

COMPETITIVE ACCESS SERVICES TARIFF

6. Switched Access Service

6.8 Rates and Charges (Cont'd)

6.8.2 Nonrecurring Rates

A. Trunk Installation

	Nonrecurring Charge
• First trunk	\$101.52
• Each additional trunk	51.27

B. Moves within the Same Serving Wire Center

Switched Access Service,
per trunk

• First trunk	101.52
• Each additional trunk	51.27

EXHIBIT 4 - COMPETITIVE LOCAL EXCHANGE

CenturyTel Broadband Services, Inc.

Page 1 of Supplement No. 1
to
Telephone – Pa. P.U.C. Tariff No. 1

Competitive Local Exchange Telecommunications Services

CENTURYTEL BROADBAND SERVICES, INC.
REGULATIONS AND RATES
GOVERNING THE FURNISHING OF
RESOLD AND FACILITIES-BASED
COMPETITIVE LOCAL EXCHANGE TELECOMMUNICATIONS SERVICES
IN PENNSYLVANIA
AS SHOWN ON TITLE PAGE 1
OF THIS TELEPHONE PA. P.U.C. TARIFF NO. 1

This Supplement No. 1 introduces Telephone – Pa. P.U.C. Tariff No. 1.

EXHIBIT 4 - COMPETITIVE LOCAL EXCHANGE

CenturyTel Broadband Services, Inc.

Page 2 of Supplement No. 1
to
Telephone – Pa. P.U.C. Tariff No. 1

Competitive Local Exchange Telecommunications Services

LIST OF CHANGES INCLUDED IN THIS SUPPLEMENT

This filing introduces Telephone – Pa. P.U.C. Tariff No. 1 containing rules and regulations pertaining to Competitive Local Exchange Telecommunications Services, consisting of the following pages:

EXHIBIT 4 - COMPETITIVE LOCAL EXCHANGE

CenturyTel Broadband Services, Inc.

Supplement No. 1
Telephone Pa. P.U.C. Tariff No. 1
Preface
Original Title Page 1

Issued: August xx, 2021
Effective: September yy, 2021

Competitive Local Exchange Telecommunications Services

This
Telephone Pa. P.U.C. Tariff No. 1
Contains regulations and rates applying to
Resale and Facilities-Based
Competitive Local Exchange Telecommunications Services
Within the Operating Territory of
CenturyTel Broadband Services, Inc.
In the Commonwealth of Pennsylvania
Terms, Conditions, Regulations and Schedule of Charges

The Company's tariff is in concurrence with all applicable State and Federal Laws, including, but not limited to Chapter 63 of 52 Pa. Code. Any provisions contained in this Tariff that are inconsistent with the Pennsylvania Public Utility Code (66 Pa. C.S.), 52 Pa. Code, the Telecommunications Act of 1996, and with the Commission's applicable Rules and Regulations and Orders will be deemed inoperative and superseded.

The Company will mirror the exchange area boundaries as stated in the tariffs of the Companies listed on Page 68 of this tariff. which include Verizon Pennsylvania LLC Telephone Pa. P.U.C. Nos. 180A, 182, 182A, 185B and 185C; Verizon North LLC Telephone Pa. P.U.C. Nos. 1, 3, 5, and 6; The United Telephone Company of Pennsylvania d/b/a CenturyLink P.U.C. No. 27; Frontier Communications Commonwealth Telephone Pa P.U.C. Nos. 23 and 24; Windstream of Pennsylvania, Inc. Pa P.U.C. No. 1; Armstrong Telephone Company – North Pa P.U.C. No. 2; Armstrong Telephone Company of Pennsylvania Pa P.U.C. No. 10; Buffalo Valley Telephone Company Pa P.U.C. No. 7; Citizens Telephone Company of Kecksburg Pa P.U.C. No. 3; Citizens Telecom Company of New York Pa P.U.C. No. 2; Conestoga Telephone & Telegraph Company Pa P.U.C. No. 10; Denver & Ephrata Telephone and Telegraph Company Pa P.U.C. No. 15; Frontier Communications of Breezewood, LLC Pa P.U.C. No. 5; Frontier Communications of Canton, LLC Pa P.U.C. No. 3; Frontier Communications of Lakewood, LLC Pa P.U.C. No. 5; Frontier Communications of Pennsylvania, LLC Pa P.U.C. No. 14; Ironton Telephone Company Pa P.U.C. No. 2; Laurel Highland Telephone Company Pa P.U.C. No. 3; The North-Eastern Pennsylvania Telephone Company Pa P.U.C. No. 9; Consolidated Communications of Pennsylvania Company Pa P.U.C. No. 1; Palmerton Telephone Company Pa P.U.C. No. 5; Pymatuning Independent Telephone Company Pa P.U.C. No. 5, Lackawaxen Telecommunications Services, Inc. Telephone – PA P.U.C. No. 2, North Penn Telephone Company Telephone – PA P.U.C. No. 2, South Canaan Telephone Company Telephone – PA P.U.C. No. 7, and TDS Telecom/Mahanoy & Mahantango Telephone Company PA P.U.C. No. 5

EXHIBIT 4 - COMPETITIVE LOCAL EXCHANGE

CenturyTel Broadband Services, Inc.

Supplement No. 1
Telephone Pa. P.U.C. Tariff No. 1
Section 1
Original Page 1

Issued: August xx, 2021
Effective: September yy, 2021

Competitive Local Exchange Telecommunications Services

1. Application and Reference

1.1 Application of Tariff

This Telephone Pa. P.U.C. Tariff No. 1 sets forth the service offerings, rates, terms and conditions applicable to the furnishing of intrastate interexchange telecommunications services furnished by CenturyTel Broadband Services, Inc. hereinafter referred to as “the Company,” to customers within the local exchange service areas of the following Local Exchange Carriers as defined herein.

Armstrong Telephone Company – North
Armstrong Telephone Company of Pennsylvania
Buffalo Valley Telephone Company
Citizens Telephone Company of Kecksburg
Citizens Telecom Company of New York
Conestoga Telephone & Telegraph Company
Consolidated Communications of Pennsylvania Company
Denver & Ephrata Telephone and Telegraph Company
Frontier Communications Commonwealth Telephone Company
Frontier Communications of Breezewood, LLC
Frontier Communications of Canton, LLC
Frontier Communications of Lakewood, LLC
Frontier Communications of Pennsylvania, LLC
Ironton Telephone Company
Lackawaxen Telecommunications Services, Inc.
Laurel Highland Telephone Company
The North-Eastern Pennsylvania Telephone Company
North Penn Telephone Company
Palmerton Telephone Company Pa
Pymatuning Independent Telephone Company
South Canaan Telephone Company
TDS Telecom/Mahanoy & Mahantango Telephone Company
The United Telephone Company of Pennsylvania d/b/a CenturyLink
Verizon Pennsylvania LLC
Verizon North LLC
Windstream of Pennsylvania, Inc.

EXHIBIT 4 - COMPETITIVE LOCAL EXCHANGE

CenturyTel Broadband Services, Inc.

Supplement No. 1
Telephone Pa. P.U.C. Tariff No. 1
Section 1
Original Page 2

Issued: August xx, 2021
Effective: September yy, 2021

Competitive Local Exchange Telecommunications Services

1. Application and Reference

1.2 Table of Contents

	<u>Page</u>
Section 1. Application And Reference	
1.1 Application of Tariff	1
1.2 Table of Contents	2
1.3 Explanation of Change Symbols	4
1.4 Explanation of Abbreviations	4
1.5 Trademarks, Service Marks and Trade Names	5
Section 2. General Regulations	
2.1 Definitions	1
2.2 Undertaking of The Company	5
2.2.1 Scope	5
2.2.2 Limitations	5
2.2.3 Liability of The Company	6
2.2.4 Special Taxes, Fees and Charges	8
2.3 Establishing and Furnishing Service	10
2.3.1 Application for Service	10
2.3.2 Obligation to Furnish Service	11
2.3.3 Limited Communication	11
2.3.4 Payment Arrangements	11
2.3.5 Special Services	12
2.3.6 Termination of Service	14
2.3.7 Termination of Service—Company Initiated	17
2.3.8 Interruption of Service	19
2.4 Payment for Service	20
2.4.1 Customer Responsibility	20
2.4.2 Payment of Bills	23
2.4.3 Customer Deposits and Advance Payments	25
2.4.4 Billing Disputes	25

EXHIBIT 4 - COMPETITIVE LOCAL EXCHANGE

CenturyTel Broadband Services, Inc.

Supplement No. 1
Telephone Pa. P.U.C. Tariff No. 1
Section 1
Original Page 3

Issued: August xx, 2021
Effective: September yy, 2021

Competitive Local Exchange Telecommunications Services

1. Application and Reference

1.2 Table of Contents (Cont'd)

Page

Section 3. Service Charges

3.1	Miscellaneous Nonrecurring Charges.....	1
3.1.1	Presubscriptions-2 (PIC-2)	1

Section 4. Reserved

Section 5. Exchange Services

5.1	Exchange Areas.....	1
5.1.1	Service Territory	1
5.1.2	Incumbent Local Exchange Carrier Exchange Areas And Local Calling Areas (LCA)	2

Section 6. Voice Offerings

6.1	Connected Voice.....	1
6.2	Federal Lifeline Assistance Program	2

Section 7. Reserved for Future Use

Section 8. Integrated Services Digital Network

8.1	Primary Rate Service Offerings	1
8.1.1	ISDN Primary Rate Interface (PRI).....	1

Section 9. Emergency Services

9.1	Telecommunications Services Priority	1
9.2	Emergency Reporting Services	2
9.2.1	Enhanced Emergency Number Service (E911).....	2

EXHIBIT 4 - COMPETITIVE LOCAL EXCHANGE

CenturyTel Broadband Services, Inc.

Supplement No. 1
Telephone Pa. P.U.C. Tariff No. 1
Section 1
Original Page 4

Issued: August xx, 2021
Effective: September yy, 2021

Competitive Local Exchange Telecommunications Services

1. Application and Reference

1.3 Explanation of Change Symbols

<u>Symbol</u>	<u>Explanation</u>
(C)	Indicates change in regulation
(I)	Indicates a rate increase
(D)	Indicates a decrease in rate

1.4 Explanation of Abbreviations

CO	- Central Office
Cont'd	- Continued
CPE	- Customer Premises/Provided Equipment
<i>DID</i>	Direct Inward Dialing
DS1	- Digital Signal 1
DS3	- Digital Signal 3
IC or IXC	- Interexchange Carrier
ICB	- Individual Case Basis
ISDN	- Integrated Services Digital Network
ISDN PRI	- Integrated Services Digital Network Primary Rate Interface
kbps	- Kilobits per Second
LATA	- Local Access and Transport Area
LCA	- Local Calling Area(s)
MRC	- Monthly Recurring Charge
NRC	- Nonrecurring Charge
NSEP	- National Security Emergency Preparedness
PIC	- Primary Interexchange Carrier
PRI	- Primary Rate Interface
TSP	- Telecommunications Service Priority

EXHIBIT 4 - COMPETITIVE LOCAL EXCHANGE

CenturyTel Broadband Services, Inc.

Supplement No. 1
Telephone Pa. P.U.C. Tariff No. 1
Section 1
Original Page 5

Issued: August xx, 2021
Effective: September yy, 2021

Competitive Local Exchange Telecommunications Services

1. Application and Reference

1.5 Trademarks, Service Marks and Trade Names

The following list of trade names, trademarks and/or service marks which may be used for services offered in this Tariff are owned by Lumen Technologies, Inc. or a subsidiary of Lumen Technologies, Inc. and are used by the Company with express permission. Trademark and service mark designations will not be listed hereafter in the Tariff. However, the laws regarding trademarks and service marks are applicable.

Trade names, trademarks and service marks that are owned by Lumen Technologies, Inc. or a subsidiary of Lumen Technologies, Inc. cannot be used by another party without authorization.

Service Mark/Trademark:

Trade Name:

CenturyLink®
Lumen®
Lumen Technologies®

CenturyLink
Lumen

Tariffed service names which are preceded by QWEST® or “Qwest,” and tariffed services which include “Qwest” as a part of the service marked or trademarked product name, may also be marketed and/or billed under the trade or brand name CenturyLink, or may be marketed and/or billed without any trade or brand name.

Mark:

QWEST®

Qwest Loyal Advantage™

Qwest Total Advantage®

EXHIBIT 4 - COMPETITIVE LOCAL EXCHANGE

CenturyTel Broadband Services, Inc.

Supplement No. 1
Telephone Pa. P.U.C. Tariff No. 1
Section 2
Original Page 1

Issued: August xx, 2021
Effective: September yy, 2021

Competitive Local Exchange Telecommunications Services

2. General Regulations

2.1 Definitions

Accessories

Devices which are mechanically attached to, or used with, the facilities furnished by the Company and which are independent of, and not electrically, acoustically, or inductively connected to, the communications path of the telecommunications system.

Authorized User

A person, firm, corporation or other entity that either is authorized by the Customer to use local exchange services or is placed in a position by the Customer, either through acts or omissions, to use local exchange services.

Company

Refers to Qwest Communications Company, LLC, which is the issuer of this Tariff.

Contractual Service Agreement

Each Contractual Service Agreement is an individually negotiated contract offering tailored to meet the telecommunications needs of the Customer(s) for whom the offering was designed. Each Contractual Service Agreement contains a service, or combination of services, and includes supplemental terms and conditions, including without limitation, prices, waivers and alternative pricing structure based upon volume, term, utilization and other needs related to the provision and receipt of telecommunication service(s) under this Tariff: special provisioning flexibility; special network monitoring; special outage credit provisions; special "turnkey" operation; and other specially developed features, functionalities or undertakings. A Contractual Service Agreement may also address, or be responsive to special competitive conditions that exist at the time a Contractual Service Agreement is agreed to between the Company and a Customer.

Unless otherwise specifically provided for under each Option set forth in this Tariff, each Option is available to all similarly situated Customers and will be provided pursuant to the identical or substantially similar terms and conditions.

EXHIBIT 4 - COMPETITIVE LOCAL EXCHANGE

CenturyTel Broadband Services, Inc.

Supplement No. 1
Telephone Pa. P.U.C. Tariff No. 1
Section 2
Original Page 2

Issued: August xx, 2021
Effective: September yy, 2021

Competitive Local Exchange Telecommunications Services

2. General Regulations

2.1 Definitions (Cont'd)

Contributory Services

Those services that contribute towards the overall commitment but are not discountable according to the master discount schedule (ie. Qwest Total Advantage). By contributing towards the overall commitment level, these services will increase the discount level that is applied to the Discount Eligible category of services under the contract. These services will continue to receive discounts as designated in individual service contracts. Contribution levels will be based on Monthly Recurring Charges (MRCs) for these services.

CPE

Customer-Provided Equipment (CPE) Telecommunication devices, equipment, and associated wiring located on the Customer's side of the protector/Standard Network Interface (SNI).

Customer

Any person, firm, partnership, corporation, municipality, cooperative organization, governmental agency or other entity to whom the Company agrees to furnish communications service under the provisions and regulations of this Tariff.

Deposit

Any payment held as security for future payment or performance to be returned after the Customer establishes a record of satisfactory credit.

Discount Eligible Service

Discount Eligible Services contribute toward the overall commitment level (ie. Qwest Total Advantage). Discount eligible products that bill on the same billing system can aggregate towards predetermined discount levels, meaning the more spent on this common group of products, the higher the customer's discount will be. Contribution levels will be based on monthly recurring charges (MRCs), counted towards the contract commitment levels and receive term and volume discounts where applicable.

EXHIBIT 4 - COMPETITIVE LOCAL EXCHANGE

CenturyTel Broadband Services, Inc.

Supplement No. 1
Telephone Pa. P.U.C. Tariff No. 1
Section 2
Original Page 3

Issued: August xx, 2021
Effective: September yy, 2021

Competitive Local Exchange Telecommunications Services

2. General Regulations

2.1 Definitions (Cont'd)

Grandfathered Service

Service that is no longer offered to new applicants but may continue for existing Customers who had the service prior to a specific date.

Individual Case Basis (ICB)

A contractual service arrangement in which the regulations, rates and charges are developed based on the specific circumstances of the Customer's situation for a specific service application.

Nonrecurring Charges (NRC)

The one-time charges for services or facilities, including but not limited to charges for construction, installation, administrative or special fees, for which the Customer becomes liable at the time the Service Order is made or executed.

Presubscription-2

An arrangement whereby a Customer may select and designate to the Company any Exchange Carrier it wishes to access, without an access code, for completing intrastate intraLATA and interLATA toll calls. The selected Exchange Carrier is referred to as the End User's Primary Interexchange Carrier (PIC-2).

Recurring Charges (MRC)

The monthly charges to the Customer for services, facilities and equipment, which continue for the agreed upon duration of the service.

EXHIBIT 4 - COMPETITIVE LOCAL EXCHANGE

CenturyTel Broadband Services, Inc.

Supplement No. 1
Telephone Pa. P.U.C. Tariff No. 1
Section 2
Original Page 4

Issued: August xx, 2021
Effective: September yy, 2021

Competitive Local Exchange Telecommunications Services

2. General Regulations

2.1 Definitions (Cont'd)

Service Address

The service address is the location where the Customer receives the Company provided service.

Service Commencement Date

The first day following the date on which the Company notifies the Customer that the requested service or facility is available for use, unless extended by the Customer's refusal to accept service which does not conform to standards set forth in the Service Order or this Tariff, in which case the Service Commencement Date is the date of the Customer's acceptance of service. The parties may mutually agree on a substitute Service Commencement Date. A Customer may not unreasonably refuse to accept service.

Standard Network Interface

The point of connection between the Customer and the Company's services which are located at the Customer's premises at a place deemed necessary by the Company in order to insure transmission quality and which is readily accessible to the Customer.

Telecommunications Service Priority (TSP)

Denotes the regulatory, administrative, and operational system developed by the Federal Government to ensure priority provisioning and/or restoration of National Security Emergency Preparedness (NSEP) telecommunications services. The Federal Communications Commission defines NSEP telecommunications services as those services which are used to maintain a state of readiness or to respond to and manage any event or crisis, which causes or could cause harm to the population, damage to or loss of property, or degrades or threatens the NSEP posture of the United States.

Termination Charge

The nonrecurring charge applicable when an agreement for service is terminated by the Customer before the expiration of the minimum agreement period.

EXHIBIT 4 - COMPETITIVE LOCAL EXCHANGE

CenturyTel Broadband Services, Inc.

Supplement No. 1
Telephone Pa. P.U.C. Tariff No. 1
Section 2
Original Page 5

Issued: August xx, 2021
Effective: September yy, 2021

Competitive Local Exchange Telecommunications Services

2. General Regulations

2.2 Undertaking of The Company

2.2.1 Scope

- A. The Company does not undertake to transmit messages under this Tariff.
- B. The Company shall be responsible only for the installation, operation and maintenance of the services, which it provides.
- C. The Company will, for maintenance purposes, test its services only to the extent necessary to detect and/or clear troubles.
- D. Services are provided 24 hours daily, seven days per week, except as set forth in other applicable sections of this Tariff.
- E. The Company does not warrant that its facilities and services meet standards other than those established for the service.

2.2.2 Limitations

- A. Services are offered subject to the availability of facilities and the provisions of this Tariff.
- B. The customer may not assign or transfer the use of services provided under this Tariff without the prior written consent of the Company.
- C. The customer may not, nor may the customer permit others to, rearrange, disconnect, remove, attempt to repair or otherwise interfere with any of the facilities or equipment installed by the Company, except upon written consent of the Company.

EXHIBIT 4 - COMPETITIVE LOCAL EXCHANGE

CenturyTel Broadband Services, Inc.

Supplement No. 1
Telephone Pa. P.U.C. Tariff No. 1
Section 2
Original Page 6

Issued: August xx, 2021
Effective: September yy, 2021

Competitive Local Exchange Telecommunications Services

2. General Regulations

2.2 Undertaking of The Company (Cont'd)

2.2.3 Liability of The Company

- A. The Company shall be indemnified and held harmless by any subscriber, user or by any other entity against claims for libel, slander or the infringement of copyright arising from the material transmitted over its services; and against all other claims arising out of any act or omission of a subscriber or of any other entity in connection with the services provided by the Company.
- B. The Company is not liable for any act or omission of any entity furnishing facilities or services connected with or provided in conjunction with the services of the Company.
- C. The Company shall not be liable for any personal injury, or death of any person or person, and for any loss or damage sustained by reason of acts, mistakes, omissions, errors or defects in providing its services, whatever shall be the cause which is not the direct result of the Company's gross negligence or willful misconduct.
- D. Except as otherwise provided herein, no liability for indirect, incidental or consequential damages shall attach to the Company, its agents, servants or employees, for damages or costs arising from errors, mistakes, omissions, interruptions, failures, delays, or defects or malfunctions of equipment or facilities, in the course of establishing, furnishing, maintaining, rearranging, moving, terminating, or changing the service or facilities (including the obtaining or furnishing of information in respect thereof or with respect to the Customer or users of the service or facilities) in the absence of willful and wanton conduct or gross negligence, whether a claim for such liability is premised upon breach of contract, breach of warranty, fulfillment of warranty, negligence, strict liability, misrepresentation, fraud, or any other theories of liability.
- E. The Company shall not be liable for any failure of performance due to causes beyond its control, including, without limitation, acts of God, fires, floods or other catastrophes, national emergencies, insurrections, riots or wars, strikes, lockouts, work stoppage or other labor difficulties, acts or omissions of other telecommunications carriers or service providers, and any law, order, regulation or other action of any governing authority or agency thereof.

EXHIBIT 4 - COMPETITIVE LOCAL EXCHANGE

CenturyTel Broadband Services, Inc.

Supplement No. 1
Telephone Pa. P.U.C. Tariff No. 1
Section 2
Original Page 7

Issued: August xx, 2021
Effective: September yy, 2021

Competitive Local Exchange Telecommunications Services

2. General Regulations

2.2 Undertaking of The Company

2.2.3 Liability of The Company (Cont'd)

- F. The Company shall not be liable to a Customer or service user or any other person, firm, entity, for any failure to perform its obligations under this Tariff due to any cause or causes beyond its reasonable control, which is not the direct result of the Company's gross negligence or willful misconduct.
- G. The remedies set forth herein shall not be exclusive and the Company at all times shall be entitled to all rights available to it under either law or equity.
- H. Customer will defend and indemnify the Company, its affiliates, agents and contractors from all third party claims and liabilities arising from or related to customer's, customer's end user's or customer's third-party provider(s)' acts, omissions (including the failure to purchase or implement features that enable the receipt and transmission of direct-dial "911" calls or multi-line telephone system notifications), or failures of connectivity that impede, prevent or otherwise make inoperable the ability of the customer or its end users to directly dial "911" or to receive or transmit multi-line telephone system notifications, as required by law, in the United States.
- I. Customer will defend and indemnify the Company, its affiliates, agents and contractors from all third party claims and liabilities arising from or related to any acts or omissions by the customer, customer's end users or customer's third-party provider(s) that cause, give rise to or bring about the non-compliance of the service with any applicable law, including the failure to purchase or implement features that enable compliance with laws.

EXHIBIT 4 - COMPETITIVE LOCAL EXCHANGE

CenturyTel Broadband Services, Inc.

Supplement No. 1
Telephone Pa. P.U.C. Tariff No. 1
Section 2
Original Page 8

Issued: August xx, 2021
Effective: September yy, 2021

Competitive Local Exchange Telecommunications Services

2. General Regulations

2.2 Undertaking of The Company

2.2.4 Special Taxes, Fees, Charges

Any sales, use, privilege, excise, franchise or occupation tax, costs of furnishing service without charge or similar taxes or impositions now or hereafter levied by the Federal, State, or Local government or any political subdivision or taxing authority thereof may be billed by the Company to its local exchange Customers on a pro rata basis in the areas wherein such taxes, impositions or other charges shall be levied against the Company, or may require collection of such taxes, fees and charges by the Company.

A. Telecommunications Relay Service (TRS) Surcharge

1. General

The Pennsylvania Telecommunications Relay Service (PA TRS) is a relay telecommunication service for the deaf, hard of hearing, hearing and/or speech disabled population of the Commonwealth. The PA TRS is mandated by the Americans with Disabilities Act of 1990 to provide functionally equivalent telephone services that are available to other U.S. citizens, at no additional cost. The PA TRS includes both traditional relay (devices such as Teletypewriters (TTY) and Telecommunication Devices for the Deaf (TDD)) and captioned-telephone voice-carry-over relay services (captioned telephone). These relay services permit telephone communications between individuals with hearing and/or speech disabilities, who must use a TTY, TDD or captioned telephone, with individuals having normal hearing and speech. Additionally, 711 abbreviated dialing is available to access the PA TRS. The Company's switching equipment is arranged to translate the "711" calls to the assigned toll-free number, (888) 895-1197, in order to route calls to the Telecommunications Relay Service Provider, in accordance with Commission's Order entered on February 4, 2000 at Docket No. M-00900239.

Local calls will be charged at the applicable local flat rate or local measured service rate. Toll calls will be charged at the applicable toll rate found in the selected long distance provider's rate schedule or current tariff. If the customer has not chosen a long distance carrier the default carrier's rates will apply for the toll calls.

EXHIBIT 4 - COMPETITIVE LOCAL EXCHANGE

CenturyTel Broadband Services, Inc.

Supplement No. 1
Telephone Pa. P.U.C. Tariff No. 1
Section 2
Original Page 9

Issued: August xx, 2021
Effective: September yy, 2021

Competitive Local Exchange Telecommunications Services

2. General Regulations

2.2 Undertaking of The Company

2.2.4 Special Taxes, Fees, Charges

A. Telecommunications Relay Service (TRS) Surcharge (Cont'd)

2. Surcharge

In addition to the charges provided in this tariff, a surcharge will apply to all residence and business access lines served by this Company. (Access lines are those lines extending from the telephone company's central office to the end-user's premises.) This surcharge applies regardless of whether or not the access line uses the PA TRS.

The surcharge serves as the funding vehicle for the operation of the PA TRS, Telecommunications Device Distribution Program and the Print Media Access Service Program and shall be calculated by the Pennsylvania Public Utility Commission (the Commission). The Commission shall compute the PA TRS surcharge each year and notify local exchange carriers of the surcharge amount to be applied for the twelve-month period commencing with July 1 of each year.

The Commission may revise the surcharge more frequently than annually at its discretion.

Tariff revisions will be filed whenever the Commission calculates a new surcharge amount and notifies the Company.

	<u>Monthly Charge</u>
Per Access Line	\$0.04

EXHIBIT 4 - COMPETITIVE LOCAL EXCHANGE

CenturyTel Broadband Services, Inc.

Supplement No. 1
Telephone Pa. P.U.C. Tariff No. 1
Section 2
Original Page 10

Issued: August xx, 2021
Effective: September yy, 2021

Competitive Local Exchange Telecommunications Services

2. General Regulations

2.3 Establishing and Furnishing Service

2.3.1 Application for Service

A. Refusal

The Company reserves the right to refuse an application for service made by a present or former Customer who is indebted to the Company for service previously furnished, until the indebtedness is satisfied. The Company may refuse to furnish or may deny service to any person, business or entity on whose premises exists any telecommunications related facility which shows any evidence of tampering, manipulating, or operation, or use of any device whatsoever, for the purpose of obtaining service without payment of the charges applicable to the service rendered. The Company may refuse to offer service where, in the Company's judgment, a service cannot reasonably be made available to a Customer.

B. Cancellations and Deferments

When the Company advises a Customer that ordered services are available on the requested due date, and the Customer is unable or unwilling to accept service at that time, the facilities will be held available for the Customer for a 30 calendar day grace period. If after 30 calendar days the Customer still has not accepted service, the Customer will be contacted and regular monthly billing for the ordered service shall begin if the Customer requests that facilities continue to be held for their future use. Otherwise, the facilities will be released for other service order activity, and cancellation charges (non-recurring charges that would have applied had the service been installed) shall be applied.

C. Use of Service

1. Limitation on Use

Service is furnished to the Customer for use only by the Customer or by employees or representatives of the Customer or by other users authorized by the Customer.

When the general service to the public is impaired or in the Company's opinion is reasonably likely to be impaired by a Customer's use of exchange service, the Company shall have the right to require the Customer to contract for and properly maintain as many additional access lines as are needed to adequately serve the Customer's requirements, or to discontinue the service of the Customer in question.

EXHIBIT 4 - COMPETITIVE LOCAL EXCHANGE

CenturyTel Broadband Services, Inc.

Supplement No. 1
Telephone Pa. P.U.C. Tariff No. 1
Section 2
Original Page 11

Issued: August xx, 2021
Effective: September yy, 2021

Competitive Local Exchange Telecommunications Services

2. General Regulations

2.3 Establishing and Furnishing Service (Cont'd)

2.3.2 Obligation to Furnish Service

- A. Facilities and lines furnished by or through the Company on the premises of a Customer, authorized user or agent of the Customer are the property of the Company and are provided upon the condition that such facilities and lines must be installed, relocated, rearranged and maintained by the Company, and that the Company's employees and agents may enter said premises at any reasonable hour to test and inspect such facilities and lines in connection with such purposes, or upon termination or cancellation of the service, to remove such facilities and lines.
- B. The Company's Obligation to Furnish Service or to continue to furnish service is dependent on its ability to obtain, retain and maintain suitable rights and facilities, and to provide for the installation of those facilities required incident to the furnishing and maintenance of that service.
- C. The Company's Obligation to Furnish Service or to continue to furnish service is dependent on the Customer's prompt payment record with the Company and its actual payments for existing service. For a new Customer, it is based on credit worthiness, which will be determined in an equitable and nondiscriminatory manner.

2.3.3 Limited Communication

The Company reserves the right to limit use of communication services when emergency conditions cause a shortage of facilities.

2.3.4 Payment Arrangements

The Customer is responsible for payment of all charges for services furnished by the Company to the Customer and/or authorized users. This responsibility is not changed by virtue of any use, misuse, or abuse of the Customer's service or Customer-provided equipment or facilities by third parties, including, without limitation, the Customer's employees or the public.

EXHIBIT 4 - COMPETITIVE LOCAL EXCHANGE

CenturyTel Broadband Services, Inc.

Supplement No. 1
Telephone Pa. P.U.C. Tariff No. 1
Section 2
Original Page 12

Issued: August xx, 2021
Effective: September yy, 2021

Competitive Local Exchange Telecommunications Services

2. General Regulations

2.3 Establishing and Furnishing Service (Cont'd)

2.3.5 Special Services

A. Work On Customer's Premises

It is contemplated that all work on Customers' premises can be performed during regular working hours. If a Customer requests that work be performed during hours which results in overtime or premium rates of pay, a charge may apply in addition to other rates and charges which may be applicable, based on the amount of overtime or premium time required, as determined on an individual case basis.

It is also contemplated that all installation, removals, service connections, moves and changes requested by a Customer be performed without the Company incurring unusual costs. If a Customer requests that work be performed in a special manner or at a special time which results in unusual costs, a charge equal to the amount of unusual costs may apply in addition to other applicable rates and charges, as determined on an individual case basis.

The Company will provide a cost estimate to the customer and obtain customer approval prior to performing work that entails overtime or premium rates or unusual costs.

B. Special Arrangements

1. The rates and charges quoted in this Tariff contemplate the use of standard arrangements, that is, the arrangement normally used by the Company to provide the type of service involved.
2. For special service arrangements to be provided by this Company, and not specifically covered in this Tariff, including but not limited to services, features, and combinations of services and features not normally offered or combined, monthly rates and the one-time charges, such as installation, nonrecurring and construction charges will apply based on the circumstances in each case. To the extent that a service is not normally offered in this tariff, the price, terms and conditions will be described in the contract.

EXHIBIT 4 - COMPETITIVE LOCAL EXCHANGE

CenturyTel Broadband Services, Inc.

Supplement No. 1

Telephone Pa. P.U.C. Tariff No. 1

Issued: August xx, 2021

Section 2

Effective: September yy, 2021

Original Page 13

Competitive Local Exchange Telecommunications Services

2. General Regulations

2.3 Establishing and Furnishing Service

2.3.5 Special Services

B. Special Arrangements (Cont'd)

3. These special equipment and service items will be provided whenever, in the judgment of the Company, there is a valid business reason for providing the service requested. In such cases, the Company reserves the right to require an initial contract period longer than one (1) month at the same location.
4. The rates, terms and conditions for these Special Arrangements offerings will be established on an individual case basis.

C. Special Promotions

The Company may, from time to time, offer promotional programs for its services which may include waiving or reducing the applicable rates and charges for the promoted service. The promotional offerings may be limited as to the duration, the date, and times of the offerings and the locations where the offerings are made or other reasonable limitations. The Company may also offer incentives, benefits or gifts to Customers to encourage the purchase or retention of any such service or product.

D. Trials

The Company may offer, from time to time, limited trials for services which may include the waiving or reducing of all rates and charges for the service that is the subject of the trial and for services that are provided as part of the trial. Trials will be intended to test new potential services or new marketing approaches for services.

E. Individual Case Basis (ICB)

In lieu of the rates otherwise set forth in this Tariff, rates and charges including installation, special construction and recurring charges for Company services may be established at negotiated rates on an ICB, taking into account the nature of the facilities and services, the costs of construction and operation, and the length of service commitment by the customer. Such arrangements shall be considered special pricing arrangements, the terms of which will be set forth in individual contracts. Special pricing arrangement rates or charges will be made available to similarly situated customers on equal terms and conditions.

EXHIBIT 4 - COMPETITIVE LOCAL EXCHANGE

CenturyTel Broadband Services, Inc.

Supplement No. 1
Telephone Pa. P.U.C. Tariff No. 1
Section 2
Original Page 14

Issued: August xx, 2021
Effective: September yy, 2021

Competitive Local Exchange Telecommunications Services

2. General Regulations

2.3 Establishing and Furnishing Service (Cont'd)

2.3.6 Termination of Service

A. Initial Service Periods

1. The initial service period for service and facilities is one month (30 days), except as otherwise specified.
2. Initial service periods for service or facilities of any class will be greater than those specified herein whenever that is required in order for the Company to protect itself from making an unwarranted investment because the Customer's location or the character of the service required is such that upon termination of the Customer's contract the facilities which have been constructed or installed to render the service are not likely to be useful for furnishing service to any other Customer.
3. Service may be terminated prior to the expiration of the initial service period upon payment of all charges due for service which has been furnished plus the termination charges as specified in this Tariff, or in the terms of the service agreement. In the case of service for which the initial period is one month, the charges due are for the balance of the month.

B. Termination Liability/Waiver Policy

Services provided via service agreements may include the Termination Liability/Waiver Policy. This policy applies only to services that specifically reference this Termination Liability/Waiver Policy as described in the Tariff.

1. Minimum Billing Level will be established for use in calculating discontinuance charges. The Minimum Billing Level is 100% percent of the total monthly rates for the service provided under the terms of the Customer's service agreement, unless otherwise specified.
2. Minimum Service Period is the period of time established in a service agreement during which the Termination Liability Charge would apply.

EXHIBIT 4 - COMPETITIVE LOCAL EXCHANGE

CenturyTel Broadband Services, Inc.

Supplement No. 1

Telephone Pa. P.U.C. Tariff No. 1

Issued: August xx, 2021

Section 2

Effective: September yy, 2021

Original Page 15

Competitive Local Exchange Telecommunications Services

2. General Regulations

2.3 Establishing and Furnishing Service

2.3.6 Termination of Service

B. Termination Liability/Waiver Policy (Cont'd)

3. If the Customer chooses to completely discontinue service, at any time during the term of the agreement, a termination charge will apply, unless the Customer satisfies the conditions specified in the Waiver Policy. The termination charge is 100% of the rates for the Minimum Service Period, if applicable, plus the Minimum Billing Level multiplied by the termination liability percentage of 50% or the rate specified in the service agreement, for the remaining term of the agreement.^[1]
4. If the Customer discontinues a portion of their service, and that causes the Customer's monthly billing level to fall below the Minimum Billing Level of the agreement, a termination charge will apply to the portion of the service agreement that is below the Minimum Billing Level.

5. Waiver Policy

A termination charge will be waived when the Customer discontinues their contracted service(s), provided all of the following conditions are met:

- The Customer signs a new service agreement for any other Company provided service(s);
- Both the existing and the new service(s) are provided solely by the Company;
- The order to discontinue the existing service(s) and the order to establish the new service(s) are received by the Company at the same time;
- The new service(s) installation must be completed within thirty calendar days of the disconnection of the old service(s), unless the installation delay is caused by the Company;

^[1] For example: Customer disconnecting in month 12 of a 36 month agreement with MRC of \$100. Termination charge is \$100 (minimum billing level) x 24 months (minimum service period) x 50% (Termination Liability Percentage) = \$1,200.

EXHIBIT 4 - COMPETITIVE LOCAL EXCHANGE

CenturyTel Broadband Services, Inc.

Supplement No. 1
Telephone Pa. P.U.C. Tariff No. 1
Section 2
Original Page 16

Issued: August xx, 2021
Effective: September yy, 2021

Competitive Local Exchange Telecommunications Services

2. General Regulations

2.3 Establishing and Furnishing Service

2.3.6 Termination of Service

B. Termination Liability/Waiver Policy

5. Waiver Policy (Cont'd)

- The total value of the new service agreement(s), excluding any special construction charges and any other nonrecurring charges, is equal to or greater than 100% of the remaining value of the existing agreement(s);
- A new minimum service period goes into effect when the new service agreement term begins;
- The Customer agrees to pay any previously billed, but unpaid recurring, and any outstanding nonrecurring charges. The charges cannot be included as part of the new service agreement;
- All applicable nonrecurring charges will be assessed for the new contracted service(s).

EXHIBIT 4 - COMPETITIVE LOCAL EXCHANGE

CenturyTel Broadband Services, Inc.

Supplement No. 1
Telephone Pa. P.U.C. Tariff No. 1
Section 2
Original Page 17

Issued: August xx, 2021
Effective: September yy, 2021

Competitive Local Exchange Telecommunications Services

2. General Regulations

2.3 Establishing and Furnishing Service (Cont'd)

2.3.7 Termination of Service – Company Initiated

- A. The Company may suspend service under the following conditions provided that, unless otherwise stated, the customer shall be given seven (7) days written notice to comply with any rule or remedy any deficiency:
1. For nonpayment of an undisputed delinquent account or the undisputed portion of an account where a dispute exists as to part but not all of an amount billed by the Company.
 2. For failure to make a deposit as security for payment of future bills, the failure to provide a guarantee or establish credit, or the failure to comply with the material terms of a payment agreement.
 3. For use of telephone service for any property or purpose other than that described in the application.
 4. In the event of abandonment of the service or any other violation by the customer of the rules, regulations or conditions under which service is furnished.
 5. Fraud or material misrepresentation of identity to obtain telephone service.
 6. Unpaid indebtedness for telephone service previously furnished by the Company in the name of the customer within four (4) years of the date the bill is rendered.
 7. In the event of unauthorized or fraudulent use of service.
 8. Without notice, when the use of the service by a customer endangers the safety of a person or appears likely to prove physically harmful to the service delivery system of the Company. At the time of suspension, the Company will mail a notice of suspension to the customer's billing address.

EXHIBIT 4 - COMPETITIVE LOCAL EXCHANGE

CenturyTel Broadband Services, Inc.

Supplement No. 1
Telephone Pa. P.U.C. Tariff No. 1
Section 2
Original Page 18

Issued: August xx, 2021
Effective: September yy, 2021

Competitive Local Exchange Telecommunications Services

2. General Regulations

2.3 Establishing and Furnishing Service

2.3.7 Termination of Service – Company Initiated (Cont'd)

- B. When at least ten (10) days have passed since suspension of service, the Company may terminate service for failure to pay a reconnection fee and to remedy the original grounds for suspension due to any of the following reasons: 1) failure to make satisfactory arrangements to pay arrearages; 2) failure to post a deposit, furnish a third-party guarantee or otherwise establish credit; 3) failure to meet the requirements of a payment agreement; or 4) failure to give adequate assurances that an unauthorized use or practice will cease.

C. Nonrecurring Charge for Restoration of Service

A reconnection fee per occurrence may be charged when service is re-established for customers who have been suspended for non-payment and is payable at the time that the restoration of suspended service and facilities is arranged. If a customer's premises visit is required, an additional fee may be charged.

Nonrecurring Reconnection Charge

- Each line restored
 - Business

\$75.00

EXHIBIT 4 - COMPETITIVE LOCAL EXCHANGE

CenturyTel Broadband Services, Inc.

Supplement No. 1
Telephone Pa. P.U.C. Tariff No. 1
Section 2
Original Page 19

Issued: August xx, 2021
Effective: September yy, 2021

Competitive Local Exchange Telecommunications Services

2. General Regulations

2.3 Establishing and Furnishing Service (Cont'd)

2.3.8 Interruption of Service

When main telephone service is interrupted for a period of at least 24 hours, the Company, after due notice by the customer, shall apply the following schedule of allowances except in situations as provided in Paragraph C following.

- A. 1/30 of the tariff monthly rate of all services and facilities furnished by the Company rendered inoperative by the Company to the extent of being useless for each of the first three full 24-hour periods during which the interruption continues after notice by the customer, when the out-of-service period extends beyond a minimum period of 24 hours.
- B. 2/30 of each full 24 hour period beyond the first three 24 hour periods. However, in no instance shall the allowance for the out-of-service period exceed the total charges in a billing period for the service and facilities furnished by the Company rendered inoperative to the extent of being useless.
- C. When service is interrupted for a period of at least 24 hours due to such factors as storms, fires, floods or other conditions beyond the control of the Company, an allowance of 1/30 of the tariff monthly rate for all services and facilities furnished by the Company rendered inoperative to the extent of being useless shall apply for each full 24 hours during which the interruption continues after notice by the customer to the Company.
- D. The allowances described above are not applicable when service is interrupted by the negligence or willful act of the customer to service or where the company, under the terms of the contract for service, suspends or terminates service for nonpayment of charges, or for unlawful or improper use of the facilities or service, or for another reason provided for in the filed and effective tariff.

EXHIBIT 4 - COMPETITIVE LOCAL EXCHANGE

CenturyTel Broadband Services, Inc.

Supplement No. 1
Telephone Pa. P.U.C. Tariff No. 1
Section 2
Original Page 20

Issued: August xx, 2021
Effective: September yy, 2021

Competitive Local Exchange Telecommunications Services

2. General Regulations

2.4 Payment for Service

2.4.1 Customer Responsibility

A. The Customer is responsible for payment of all charges for facilities and services furnished to the Customer, including charges for services originated, terminated, or accepted, at such facilities.

B. Multi-Line Telephone Systems

1. Pursuant to 47 CFR §9.16(b)(1) and (2), multi-line telephone systems connected to the Company's network which were manufactured, imported, sold, leased, or installed after February 16, 2020 must be configured to:

- allow an end user to directly initiate a "911" call from any station equipped with dialing facilities, without dialing any additional digit, code, prefix, or post-fix, including any trunk-access code such as the digit 9, regardless of whether the user is required to dial such a digit, code, prefix, or post-fix for other calls, and
- provide MLTS notification to a central location at the facility where the system is installed or to another person or organization regardless of location, if the system is able to be configured to provide the notification without an improvement to the hardware or software of the system.

MLTS notification must (1) be initiated contemporaneously with the 911 call, provided that it is technically feasible to do so; (2) not delay the call to 911; and (3) be sent to a location where someone is likely to see or hear it.

Customers who connect multi-line telephone systems to the Company's facilities must agree to defend and indemnify the Company for acts and omissions resulting in non-compliance, as described in Section 2.2.3.H.

EXHIBIT 4 - COMPETITIVE LOCAL EXCHANGE

CenturyTel Broadband Services, Inc.

Supplement No. 1
Telephone Pa. P.U.C. Tariff No. 1
Section 2
Original Page 21

Issued: August xx, 2021
Effective: September yy, 2021

Competitive Local Exchange Telecommunications Services

2. General Regulations

2.4 Payment for Service

2.4.1 Customer Responsibility

B. Multi-Line Telephone Systems (Cont'd)

2. Pursuant to 47 C.F.R. § 9.16(b)(3), a person engaged in the business of installing MLTS may not install such a system in the United States unless it is configured such that it is capable of being programmed with and conveying the dispatchable location of the caller, as defined in 47 C.F.R. § 9.3, to the PSAP with 911 calls consistent with the requirements below. A person engaged in the business of managing or operating MLTS may not manage or operate such a system in the United States unless it is configured such that the dispatchable location of the caller, as defined in 47 C.F.R. §9.3, is conveyed to the PSAP with 911 calls consistent with the following requirements:
 - On-premise fixed telephones associated with a MLTS must provide dispatchable location by January 6, 2021;
 - No later than January 6, 2022, on-premise non-fixed telephones associated with a MLTS must provide dispatchable location where technically feasible, otherwise they shall provide dispatchable location based on end user manual update or on alternative location information as defined in 47 C.F.R. § 9.3;
 - No later than January 6, 2022, off-premise non-fixed telephones associated with a MLTS must provide dispatchable location where technically feasible, otherwise they shall provide dispatchable location based on end user manual update, or enhanced location information which may be coordinate based and consisting of the best available location that can be obtained from any available technology or combination of technologies at reasonable cost.

EXHIBIT 4 - COMPETITIVE LOCAL EXCHANGE

CenturyTel Broadband Services, Inc.

Supplement No. 1
Telephone Pa. P.U.C. Tariff No. 1
Section 2
Original Page 22

Issued: August xx, 2021
Effective: September yy, 2021

Competitive Local Exchange Telecommunications Services

2. General Regulations

2.4 Payment for Service

2.4.1 Customer Responsibility

B. Multi-Line Telephone Systems

2. Pursuant to 47 C.F.R. § 9.16(b)(3)...the following requirements: (Cont'd)

- Additionally, providers of fixed telephony services shall provide automated dispatchable location with 911 calls beginning January 6, 2021 pursuant to 47 C.F.R. § 9.8. Providers of interconnected VoIP service must comply with the location requirements under 47 C.F.R. § 9.11(b)(iv) for non-fixed services as of January 6, 2022. Customers to DID Service capable of accessing 911 emergency services shall be responsible for providing automated dispatchable location information as defined in 47 C.F.R. § 9.3 and for maintaining the accuracy of that information for fixed services as of January 6, 2021 and for non-fixed services where technically feasible as of January 6, 2022.
- Customers, particularly private switch owners, private branch exchange owners, and customers of DID service, may need to purchase additional features or services to comply with the dispatchable location provisions of RAY BAUM's Act. Dispatchable location capability may require Customers to purchase private switch automatic location identification (PS/ALI) service from the Company or from a third-party provider.

Customers who connect multi-line telephone systems to the Company's facilities must agree to defend and indemnify the Company for acts and omissions resulting in non-compliance, as described in Section 2.2.3.I.

EXHIBIT 4 - COMPETITIVE LOCAL EXCHANGE

CenturyTel Broadband Services, Inc.

Supplement No. 1
Telephone Pa. P.U.C. Tariff No. 1
Section 2
Original Page 23

Issued: August xx, 2021
Effective: September yy, 2021

Competitive Local Exchange Telecommunications Services

2. General Regulations

2.4 Payment for Service

2.4.2 Payment of Bills

A. Charges Due

Charges for local exchange service and facilities are billed in advance. Payment is due as required by statute or state administrative rules. All bills are payable by any means mutually acceptable to the Customer and the Company. Failure to receive a bill does not exempt the Customer from prompt payment of their account. The Customer is held responsible for all charges for local exchange service and facilities furnished at the Customer's request.

The Company shall utilize credit policies and reasonable and equitable methods in its debt collection practices as specified by state and federal government regulations.

B. Returned Payment Charge

A returned payment charge in the amount of \$25, or a lesser amount as permitted by state rule or law, may apply to the Customer's account for each occasion that a check, bank draft, or an electronic funds transfer item is returned to the Company for the reason for insufficient funds or no account.

C. Late Payment Charge

1. Billing will be payable upon receipt. The date of payment is the date the payment is received by the Company. Amounts not paid within 30 days after the invoice is rendered will be considered past due. A late payment charge at the rate of 1.5% per month (unless a lower rate is prescribed by law, in which event at the highest rate allowed by law) may accrue upon any unpaid amount commencing five days after the date the payment is past due. When billing is provided by a local exchange company on behalf of the Company, the local exchange company's late payment charge applies to all past due amounts, if applicable.

EXHIBIT 4 - COMPETITIVE LOCAL EXCHANGE

CenturyTel Broadband Services, Inc.

Supplement No. 1
Telephone Pa. P.U.C. Tariff No. 1
Section 2
Original Page 24

Issued: August xx, 2021
Effective: September yy, 2021

Competitive Local Exchange Telecommunications Services

2. General Regulations

2.4 Payment for Service

2.4.2 Payment of Bills

C. Late Payment Charge (Cont'd)

2. Collection procedures, temporary disconnection of service, and the requirements for deposit are unaffected by the application of a late payment charge.

D. Notice of Suspension

In the event it becomes necessary for service to be discontinued to a Customer for nonpayment, a written notice, mailed or delivered no sooner than five (5) days following the original due date of the bill, will be given advising the Customer of the amount due and the date by which the same must be paid. If the Customer fails to pay or make suitable arrangements for payment by said due date, the Company may suspend the service or discontinue the service and remove any or all of its equipment from the Customer's premises.

EXHIBIT 4 - COMPETITIVE LOCAL EXCHANGE

CenturyTel Broadband Services, Inc.

Supplement No. 1

Telephone Pa. P.U.C. Tariff No. 1

Issued: August xx, 2021

Section 2

Effective: September yy, 2021

Original Page 25

Competitive Local Exchange Telecommunications Services

2. General Regulations

2.4 Payment for Service (Cont'd)

2.4.3 Customer Deposits and Advance Payments

A. Deposits From Applicants for Service and Present Customers

1. Any applicant or Customer whose financial responsibility is not established to the satisfaction of the Company may be required to provide a deposit to the Company, pursuant to the provisions in state rules. The deposit will bear interest at a rate required or allowed by state laws or regulations.
2. The payment of a deposit shall in no way relieve the applicant or Customer from complying with the Tariff rules and regulations for the prompt payment of bills on presentation.

B. Advance Payment

To safeguard its interests, the Company may require the Customer to make an advance payment before services and facilities are furnished. in the following cases: 1) the construction of facilities and furnishing of special equipment, or 2) temporary service for short-term use. The advance payment will not exceed an amount equal to the nonrecurring charge(s) and one month's charges for the service or facility. In addition, where special construction is involved, the advance payment may also include an amount equal to the estimated nonrecurring charges for the special construction. The advance payment will be credited to the customer's initial bill. An advance payment may be required in addition to a deposit.

2.4.4. Billing Disputes

The customer is responsible for notifying the Company of any charges in dispute and the specific basis of such dispute. All charges not in dispute shall be paid by the customer by the payment due date. Upon notification of a dispute, the Company shall undertake an investigation of the disputed charges. At the conclusion of the investigation, the Company shall notify the customer of any amount determined by the Company to be correctly charged and such amount shall become immediately due and owing. Amounts determined by the Company to be correctly charged shall also be subject to the late payment charge specified in this Tariff. In the case of unresolved disputes the customer may contact the Bureau of Consumer Services at the following address:

The Bureau of Consumer Services
The Pennsylvania P.U.C.
P.O. Box 3265
Harrisburg, PA 17120
Telephone No: 1-800-782-1110

EXHIBIT 4 - COMPETITIVE LOCAL EXCHANGE

CenturyTel Broadband Services, Inc.

Supplement No. 1
Telephone Pa. P.U.C. Tariff No. 1
Section 3
Original Page 1

Issued: August xx, 2021
Effective: September yy, 2021

Competitive Local Exchange Telecommunications Services

3. Service Charges

3.1 Miscellaneous Nonrecurring Charges

A nonrecurring charge is a one-time charge associated with a given service or item of equipment made under certain conditions to customer-initiated requests to install, move, or change telephone service.

Nonrecurring charges, where applicable, are specified with services as stated in each section of this Tariff unless otherwise specified or included in this section.

3.1.1 Presubscriptions-2 (PIC-2)

- A. Toll presubscription is a procedure whereby a customer designates to the Company the IntraLATA and InterLATA toll providers, i.e., interexchange carriers (IXCs) which the customer wishes to be the carriers of choice for toll calls. Such calls are automatically directed to the designated carrier(s) without the need to use carrier access codes or additional dialing to direct the calls to the designated carrier. Toll presubscription does not prevent a customer, who has presubscribed to a toll carrier, from using carrier access codes or additional dialing to direct calls to an alternative toll carrier on a per call basis.

Each carrier will have one or more access codes assigned to it for various types of service. When an end user selects a carrier as its preferred IXC, only one access code of that carrier may be incorporated into the switching system of the telephone company permitting access to that carrier by the end user without dialing an access code. Should the same end user wish to use other services of the same carrier, it will be necessary for the end user to dial the necessary access code(s) to reach that carrier's other service(s).

An IXC must use Feature Group D (FGD) Switched Access Service to qualify as a presubscription toll provider unless prior arrangements have been made with or by the Company. IXCs must submit an Access Service Request (ASR) to the Company.

Selection of a toll presubscription provider by an end user is subject to the terms and conditions following.

EXHIBIT 4 - COMPETITIVE LOCAL EXCHANGE

CenturyTel Broadband Services, Inc.

Supplement No. 1
Telephone Pa. P.U.C. Tariff No. 1
Section 3
Original Page 2

Issued: August xx, 2021
Effective: September yy, 2021

Competitive Local Exchange Telecommunications Services

3. Service Charges

3.1 Miscellaneous Nonrecurring Charges

3.1.1 Presubscriptions-2 (PIC-2)(Cont'd)

B. At the option of the IXCs, the nonrecurring charge for a change in toll presubscription, as provided herein, may be billed to the IXCs, instead of the end user. This may involve charges resulting from end-user initial free choice Preferred Interexchange Carrier (PIC), as specified in C.1. following.

C. Presubscription Charge Application

1. End user choices for toll presubscription:

- Designating an intraLATA and interLATA IXC(s) as primary carrier(s) thereby requiring no access code to access those IXCs' service. End users are not required to choose the same IXC for intraLATA and interLATA toll presubscription. Other nonpresubscribed IXCs are accessed by dialing 10XXX, 101XXXX, or other required codes.
- Choosing no carrier as a primary carrier thus requiring 10XXX or 101XXXX code dialing to access all IXCs.

2. If a new customer cannot decide upon presubscription IXCs, the Company may extend a 30-day period following completion of the initial service request to make a choice without charge. In the interim, the customer will be assigned as a 'No-PIC' and must dial an access code to make toll calls.

3. If an IXC elects to discontinue Feature Group D, the IXC is obligated to contact, in writing, all end users who have selected the canceling IXC as their preferred toll provider. The IXC must inform the end users that it is canceling its Feature Group D Service, request that the end user select a new IXC, and state that the canceling IXC will pay the PIC change charge as provided herein. The IXC must provide written notification to the Company that this activity has taken place.

Following the IXC's discontinuance of service, the Company will bill or waive the canceling IXC the change charge for each end user that is currently designated to the IXC at the time of discontinuance.

EXHIBIT 4 - COMPETITIVE LOCAL EXCHANGE

CenturyTel Broadband Services, Inc.

Supplement No. 1
Telephone Pa. P.U.C. Tariff No. 1
Section 3
Original Page 3

Issued: August xx, 2021
Effective: September yy, 2021

Competitive Local Exchange Telecommunications Services

3. Service Charges

3.1 Miscellaneous Nonrecurring Charges

3.1.1 Presubscriptions-2 (PIC-2)

C. Presubscription Charge Application (Cont'd)

4. An unauthorized PIC change is a change in the presubscribed IXC that the end user denies authorizing. PIC disputes for end users are resolved through an investigative process.

If an unauthorized change in toll presubscription occurs, the IXC making the unauthorized change will be assessed a charge for unauthorized change in presubscription as provided at the end of this section. In addition, the IXC will be assessed the applicable charge for returning the end user to the preferred IXC.

If an unauthorized change in intraLATA and interLATA presubscription occurs at the same time on the same Business line, and the presubscribed IXC is the same carrier for intraLATA and interLATA, presubscription change charges as provided herein and the Company's Rates and Services Schedule Interstate No. 3 apply. In addition, the IXC will be assessed the applicable charges for returning the end user to the preferred IXC as provided herein and in the Company's Rates and Services Schedule Interstate No. 3.

D. End User Charge Discrepancy

1. When a discrepancy is determined regarding an end user's designation of a presubscription IXC, the following applies depending upon the situation described:
 - A signed letter of authorization takes precedence over an order other than subsequent, direct customer contact with the Company.
 - When two or more orders are received for an end user line generated by telemarketing, the date field on the mechanized record used to transmit PIC change information will be used as the PIC authorization date. The order with the latest application date/time determines customer choice.
 - If an end user denies requesting a change in toll presubscription as submitted by an IXC, and the IXC is unable to produce a letter of authorization, signed by the end user, the IXC will be assessed all applicable change charges. The nonrecurring change charges are provided herein. The IXC will also be assessed the presubscription change charge as specified herein, which was previously billed to the end user.

EXHIBIT 4 - COMPETITIVE LOCAL EXCHANGE

CenturyTel Broadband Services, Inc.

Supplement No. 1
Telephone Pa. P.U.C. Tariff No. 1
Section 3
Original Page 4

Issued: August xx, 2021
Effective: September yy, 2021

Competitive Local Exchange Telecommunications Services

3. Service Charges

3.1 Miscellaneous Nonrecurring Charges

3.1.1 Presubscriptions-2 (PIC-2)

D. End User Charge Discrepancy (Cont'd)

2. Verification of Orders for Telemarketing

Neither the IXC or the Company shall submit a PIC change order generated by outbound telemarketing unless and until the order has first been confirmed in accordance with the F.C.C.'s current anti-slamming practices and procedures.

E. PIC Switchback Option - Business/Residence

PIC Switchback is an option under which no investigation activities are performed by the Company when an end user denies requesting a change in primary toll carrier submitted by IXCs. The IXC participating in PIC Switchback will be billed the PIC Switchback Charge, and the presubscription change charge, as specified herein, to switch the end user to the end user's previous carrier.

When the Company is contacted by an end user who denies requesting a change in primary toll carrier, the end user will be credited the charge assessed for the disputed change in carrier, and will be switched back to the previous IXC at no charge. If this service is made available by the Company, IXCs may subscribe to or cancel PIC Switchback Service on 30 days notice to the Company by submitting a written request. A letter of authorization from the IXC will not be requested or accepted at a later date in the event of dispute of the charges assessed under the PIC Switchback option.

This option in no way relieves an IXC of the F.C.C. requirements for verifying all PIC orders obtained by outbound telemarketing prior to submitting those orders, or instituting steps to obtain verification of orders submitted to the Company.

In addition, the end user has the option of initiating a complaint to the F.C.C. or the Pennsylvania Public Utility Commission's Bureau of Consumer Services concerning unauthorized changes in toll presubscription.

EXHIBIT 4 - COMPETITIVE LOCAL EXCHANGE

CenturyTel Broadband Services, Inc.

Supplement No. 1
Telephone Pa. P.U.C. Tariff No. 1
Section 3
Original Page 5

Issued: August xx, 2021
Effective: September yy, 2021

Competitive Local Exchange Telecommunications Services

3. Service Charges

3.1 Miscellaneous Nonrecurring Charges

3.1.1 Presubscriptions-2 (PIC-2) (Cont'd)

F. Primary Interexchange Carrier Change Charge

InterLATA Presubscription is available pursuant to the Company's Interexchange Rates and Services Schedules

	<u>Nonrecurring Charge</u>
<ul style="list-style-type: none">PIC Change Charge, per line, per occurrence	\$5.00

EXHIBIT 4 - COMPETITIVE LOCAL EXCHANGE

CenturyTel Broadband Services, Inc.

Supplement No. 1
Telephone Pa. P.U.C. Tariff No. 1
Section 4
Original Page 1

Issued: August xx, 2021
Effective: September yy, 2021

Competitive Local Exchange Telecommunications Services

4. Reserved

EXHIBIT 4 - COMPETITIVE LOCAL EXCHANGE

CenturyTel Broadband Services, Inc.

Supplement No. 1
Telephone Pa. P.U.C. Tariff No. 1
Section 5
Original Page 1

Issued: August xx, 2021
Effective: September yy, 2021

Competitive Local Exchange Telecommunications Services

5. Exchange Services

5.1 Exchange Areas

5.1.1 Service Territory

An exchange is a geographically defined area established by the Company for the administration of telecommunication services.

In those exchanges and zones in which the Company initiates and provides local exchange service within the service territories of the ILECs listed below, the exchanges and zones in the Local Calling Areas shall be identical to the exchanges and zones within the Local Calling Areas of the incumbent local exchange provider unless otherwise tariffed herein. Where local service is being provided by the Company, the Company concurs with the exchange areas and maps filed by the ILECs.

Armstrong Telephone Company – North
Armstrong Telephone Company of Pennsylvania
Buffalo Valley Telephone Company
Citizens Telephone Company of Kecksburg
Citizens Telecom Company of New York
Conestoga Telephone & Telegraph Company
Consolidated Communications of Pennsylvania Company
Denver & Ephrata Telephone and Telegraph Company
Frontier Communications Commonwealth Telephone Company
Frontier Communications of Breezewood, LLC
Frontier Communications of Canton, LLC
Frontier Communications of Lakewood, LLC
Frontier Communications of Pennsylvania, LLC
Ironton Telephone Company
Lackawaxen Telecommunications Services, Inc.
Laurel Highland Telephone Company
Marianna and Scenery Hill Telephone Company
The North-Eastern Pennsylvania Telephone Company
North Penn Telephone Company
Palmerton Telephone Company Pa
Pymatuning Independent Telephone Company
South Canaan Telephone Company
TDS Telecom/Mahanoy & Mahantango Telephone Company
The United Telephone Company of Pennsylvania d/b/a CenturyLink
Verizon Pennsylvania LLC
Verizon North LLC
Windstream of Pennsylvania, Inc.

EXHIBIT 4 - COMPETITIVE LOCAL EXCHANGE

CenturyTel Broadband Services, Inc.

Supplement No. 1
Telephone Pa. P.U.C. Tariff No. 1
Section 5
Original Page 2

Issued: August xx, 2021
Effective: September yy, 2021

Competitive Local Exchange Telecommunications Services

5. Exchange Services

5.1 Exchange Areas (Cont'd)

5.1.2 Incumbent Local Exchange Carrier Exchange Areas and Local Calling Areas (LCA)

Local Calling Areas include all stations bearing the Central Office designLocal Calling Areas include all stations bearing the Central Office designations of the listed exchanges, unless otherwise noted.

Services described in Sections 6 and 8 of this Telephone Pa. P.U.C. Tariff No. 1 will be provided Customers, at Customer premises located in these areas pursuant to this or the Incumbent Local Exchange Carrier tariff, to the extent that: (a) Company has in place and available network facilities extending to such premises; or (b) Customer's premises is served by an ILEC wire center at which the Company maintains a colocation agreement and is able to reasonably employ such arrangement to interconnect to unbundled exchange link facilities which Company, in its sole discretion, judges to be of a type, grade, technical specification, quality and quantity sufficient to, and offered under conditions consistent with, the delivery of such services.

A. Verizon Pennsylvania Inc. Exchange Areas and Local Calling Areas

Exchange Area	Exchange, Zone or Wire Center Included in the Local Calling Area
Alexandria	Alexandria, Huntingdon, McConnellstown (CenturyLink)
Aliquippa	Aliquippa, Ambridge, Baden Glenwillard, Hookstown, Pitb. Subn. Zone 16, Rochester
Allentown	Allentown, Bath, Bethlehem, Catasauqua, Coopersburg (Commonwealth Tel.), Easton Emmaus (Verizon North), Hellertown, Ironton (Ironton Tel. Co.), Kutztown, Nazareth, New Smithville (Verizon North), New Tripoli (Verizon North), Northampton, Riegelsville, Slatington, Springtown, Topton (Conestoga Tel. & Tel. Co.)

EXHIBIT 4 - COMPETITIVE LOCAL EXCHANGE

CenturyTel Broadband Services, Inc.

Supplement No. 1
Telephone Pa. P.U.C. Tariff No. 1
Section 5
Original Page 3

Issued: August xx, 2021
Effective: September yy, 2021

Competitive Local Exchange Telecommunications Services

5. Exchange Services

5.1 Exchange Areas

5.1.2 Incumbent Local Exchange Carrier Exchange Areas and Local Calling Areas (LCA)

A. Verizon Pennsylvania Inc. Exchange Areas and Local Calling Areas (Cont'd)

Exchange Area	Exchange, Zone or Wire Center Included in the Local Calling Area
Altoona	Altoona, Bellwood, Cresson, Hollidaysburg, Tyrone
Ambridge	Aliquippa, Ambridge, Baden, Glenwillard, Pitb. Subn. Zone 16
Annville	Annville, Hershey (Verizon North), Jonestown (Verizon North), Lebanon, Mt. Gretna, Palmyra
Ashland	Ashland, Frackville, Girardville, Kulpmont, Mt. Carmel, Shenandoah
Austin	Austin, Countersport
Avella	Avella, Burgettstown, Washington
Avis	Avis, Jersey Shore, Lock Haven, Woolrich
Avondale	Avondale, Coatesville, Kemblesville, Kennett Square, Landenberg, Lenape, Mendenhall, Mortonville, Oxford, Unionville, West Chester, West Grove, Westtown, Hockessin, DE. (Verizon – DE.), Wilmington, DE. (Verizon – DE.)
Baden	Aliquippa, Ambridge, Baden, Rochester
Barnesboro	Barnesboro, Carrolltown, Cherry Tree, Glen Campbell, Hastings, Patton
Bath	Allentown, Bath, Bethlehem, Catasauqua, Easton, Nazareth, Northampton, Slatington

EXHIBIT 4 - COMPETITIVE LOCAL EXCHANGE

CenturyTel Broadband Services, Inc.

Supplement No. 1
Telephone Pa. P.U.C. Tariff No. 1
Section 5
Original Page 4

Issued: August xx, 2021
Effective: September yy, 2021

Competitive Local Exchange Telecommunications Services

5. Exchange Services

5.1 Exchange Areas

5.1.2 Incumbent Local Exchange Carrier Exchange Areas and Local Calling Areas (LCA)

A. Verizon Pennsylvania Inc. Exchange Areas and Local Calling Areas (Cont'd)

Exchange Area	Exchange, Zone or Wire Center Included in the Local Calling Area
Beaver Falls	Beaver Falls, Darlington (Windstream), Ellwood City, Enon Valley (Windstream), Hookstown, Midland, Rochester, Wampum, Zelienople
Bedminister	Bedminster, Carversville, Doylestown, Dublin, Ferndale (Commonwealth Tel.), Perkasio, Plumsteadville, Quakertown
Bellefonte	Bellefonte, Boalsburg, Centre Hall, Howard (CenturyLink), Snow Shoe, Spring Mills, State College, Zion (CenturyLink)
Belle Vernon	Belle Vernon, California, Charleroi, Donora, Fayette City, Monessen, Monongahela, Perryopolis, West Newton
Bellwood	Altoona, Bellwood, Tyrone
Berwick	Berwick, Bloomsburg, Shickshinny (Commonwealth Tel.), Wapwallopen (Commonwealth Tel.)
Bessemer	Bessemer, New Castle
Bethlehem	Allentown, Bath, Bethlehem, Catasauqua, Coopersburg (Commonwealth Tel.), Easton, Hellertown, Ironton (Ironton Tel. Co.), Nazareth, Northampton, Riegelsville, Slatington, Springtown

EXHIBIT 4 - COMPETITIVE LOCAL EXCHANGE

CenturyTel Broadband Services, Inc.

Supplement No. 1

Telephone Pa. P.U.C. Tariff No. 1

Issued: August xx, 2021

Section 5

Effective: September yy, 2021

Original Page 5

Competitive Local Exchange Telecommunications Services

5. Exchange Services

5.1 Exchange Areas

5.1.2 Incumbent Local Exchange Carrier Exchange Areas and Local Calling Areas (LCA)

A. Verizon Pennsylvania Inc. Exchange Areas and Local Calling Areas (Cont'd)

Exchange Area	Exchange, Zone or Wire Center Included in the Local Calling Area
Big Run	Big Run, Punxsutawney
Black Lick	Black Lick, Blairsville, Homer City, Indiana
Blairsville	Black Lick, Blairsville, Bolivar, Derry, Homer City, Indiana, Latrobe
Bloomsburg	Berwick, Bloomsburg, Catawissa, Danville, Millville, Numidia, Orangeville (Commonwealth Tel.), Washingtonville
Boalsburg	Bellefonte, Boalsburg, Centre Hall, Spring Mills, State College
Bolivar	Blairsville, Bolivar, New Florence
Bradford	Bradford, Duke Center (Armstrong North), Eldred, Mount Jewett, Rew, Smethport, Limestone, NY (Verizon – NY)
Brownsville	Brownsville, California, Charleroi, New Salem, Republic, Smock, Uniontown
Buckingham	Buckingham, Carversville, Doylestown, New Hope, Phila. Subn. Zone 45, Wycombe
Burgettstown	Avella, Burgettstown, McDonald, Midway (Windstream), Murdocksville (Armstrong), Paris
Bushkill	Bushkill, Lords Valley, Stroudsburg, Stroudsburg, NJ (Verizon – NJ)

EXHIBIT 4 - COMPETITIVE LOCAL EXCHANGE

CenturyTel Broadband Services, Inc.

Supplement No. 1
Telephone Pa. P.U.C. Tariff No. 1
Section 5
Original Page 6

Issued: August xx, 2021
Effective: September yy, 2021

Competitive Local Exchange Telecommunications Services

5. Exchange Services

5.1 Exchange Areas

5.1.2 Incumbent Local Exchange Carrier Exchange Areas and Local Calling Areas (LCA)

A. Verizon Pennsylvania Inc. Exchange Areas and Local Calling Areas (Cont'd)

Exchange Area	Exchange, Zone or Wire Center Included in the Local Calling Area
California	Belle Vernon, Brownsville, California, Charleroi, Fayette City
Canonsburg	Canonsburg, Hickory (Hickory Tel. Co.), McDonald, McMurray, Pitb. Subn. Zone 13, Washington
Carbondale	Carbondale, Chapman Lake (Verizon North), Clifford (The North-Eastern Pa. Tel. Co.), Forest City (The North-Eastern Pa. Tel. Co.), Jermyn, Olyphant, Scranton, Waymart (The South Canaan Tel. Co.)
Carrolltown	Barnesboro, Carrolltown, Ebensburg, Hastings, Patton
Carversville	Bedminster, Buckingham, Carversville, Doylestown, Dublin, New Hope, Plumsteadville, Wycombe
Catasauqua	Allentown, Bath, Bethlehem, Catasauqua, Easton, Hellertown, Ironton (Ironton Tel. Co), Nazareth, Northampton, Riegelsville, Slatington, Springtown
Catawissa	Bloomsburg, Catawissa, Danville, Elysburg, Numidia
Center Point	Center Point, Collegeville, Harleysville, Lansdale, Phila. Subn. Zone 30, North Wales, Schwenksville

EXHIBIT 4 - COMPETITIVE LOCAL EXCHANGE

CenturyTel Broadband Services, Inc.

Supplement No. 1
Telephone Pa. P.U.C. Tariff No. 1
Section 5
Original Page 7

Issued: August xx, 2021
Effective: September yy, 2021

Competitive Local Exchange Telecommunications Services

5. Exchange Services

5.1 Exchange Areas

5.1.2 Incumbent Local Exchange Carrier Exchange Areas and Local Calling Areas (LCA)

A. Verizon Pennsylvania Inc. Exchange Areas and Local Calling Areas (Cont'd)

Exchange Area	Exchange, Zone or Wire Center Included in the Local Calling Area
Centre Hall	Bellefonte, Boalsburg, Centre Hall, Millheim, Spring Mills, State College
Charleroi	Belle Vernon, Brownsville, California, Charleroi, Donora, Fayette City, Monessen, Monongahela
Cherry Tree	Barnesboro, Cherry Tree, Clymer, Glen Campbell
Chester Springs	Chester Springs, Eagle, Exton, Phila. Subn. Zone 28, Phoenixville, Pughtown, Royersford
Clairton	Clairton, Elizabeth, Pitb. Subn. Zone 10, Pitb. Subn. Zone 11
Clarion	Clarion, Knox (Windstream), Leeper, Shipperville (Windstream), Sligo (Windstream), Strattanville (Windstream)
Claysville	Claysville, Washington, West Alexander
Clearfield	Clearfield, Curwensville, Frenchville, Osceola Mills, Philipsburg, Winburne
Clymer	Clymer, Indiana
Coatesville	Avondale, Coatesville, Downingtown, Eagle, Exton, Glenmoore, Honey Brook, Kennett Square, Lenape, Mortonville, Parkesburg, Unionville, West Chester, West Grove, Westtown

EXHIBIT 4 - COMPETITIVE LOCAL EXCHANGE

CenturyTel Broadband Services, Inc.

Supplement No. 1
Telephone Pa. P.U.C. Tariff No. 1
Section 5
Original Page 8

Issued: August xx, 2021
Effective: September yy, 2021

Competitive Local Exchange Telecommunications Services

5. Exchange Services

5.1 Exchange Areas

5.1.2 Incumbent Local Exchange Carrier Exchange Areas and Local Calling Areas (LCA)

A. Verizon Pennsylvania Inc. Exchange Areas and Local Calling Areas (Cont'd)

Exchange Area	Exchange, Zone or Wire Center Included in the Local Calling Area
Collegeville	Center Point, Collegeville, Green Lane, Harleysville, Lansdale, North Wales, Phila. Subn. Zone 29, Phila. Subn. Zone 30, Phila. Subn. Zone 31, Phoenixville, Pottstown, Royersford, Schwenksville, Souderton
Connellsville	Connellsville, Dawson, Mount Pleasant, Scottdale, Uniontown
Coudersport	Austin, Coudersport, Roulette, Ulysses
Cresco	Cresco, Lords Valley, Mount Pocono, Newfoundland, Stroudsburg
Cresson	Altoona, Cresson, Ebensburg, Hollidaysburg, Portage
Curwensville	Clearfield, Curwensville, Mahafey
Danville	Bloomsburg, Catawissa, Danville, Elysburg, Northumberland, Sunbury, Washingtonville
Dauphin	Dauphin, Halifax, Harrisburg Zone 1
Dawson	Connellsville, Dawson, Perryopolis, Scottdale
Derry	Blairsville, Derry, Greensburg, Latrobe
Donora	Belle Vernon, Charleroi, Donora, Elizabeth, Monessen, Monongahela

EXHIBIT 4 - COMPETITIVE LOCAL EXCHANGE

CenturyTel Broadband Services, Inc.

Supplement No. 1

Telephone Pa. P.U.C. Tariff No. 1

Issued: August xx, 2021

Section 5

Effective: September yy, 2021

Original Page 9

Competitive Local Exchange Telecommunications Services

5. Exchange Services

5.1 Exchange Areas

5.1.2 Incumbent Local Exchange Carrier Exchange Areas and Local Calling Areas (LCA)

A. Verizon Pennsylvania Inc. Exchange Areas and Local Calling Areas (Cont'd)

Exchange Area	Exchange, Zone or Wire Center Included in the Local Calling Area
Dowlingtown	Chester Springs, Coatesville, Downingtown, Eagle, Exton, Glenmoore, Honey Brook, Lenape, Mortonville, Phila. Subn. Zone 28, Pughtown, West Chester, Westtown
Doylestown	Buckingham, Carversville, Doylestown, Dublin, Line Lexington, Phila. Subn. Zone 45, Plumsteadville, Wycombe
Dublin	Bedminster, Buckingham, Carversville, Doylestown, Dublin, Lansdale, Line Lexington, Perkasio, Plumsteadville, Quakertown, Souderton
DuBois	Brockway (Windstream), DuBois, Luthersburg (Windstream), Penfield (Windstream), Reynoldsville, Sykesville
Eagle	Chester Springs, Coatesville, Downingtown, Eagle, Exton, Glenmoore, Phila. Subn. Zone 28, Phoenixville, Pughtown, Royersford, West Chester
East Palestine	East Palestine, Pa., East Palestin, O. (AMERITECH, O.), New Waterford, O. (AMERITECH, O.), Rogers, O. (AMERITECH, O.)

EXHIBIT 4 - COMPETITIVE LOCAL EXCHANGE

CenturyTel Broadband Services, Inc.

Supplement No. 1

Telephone Pa. P.U.C. Tariff No. 1

Issued: August xx, 2021

Section 5

Effective: September yy, 2021

Original Page 10

Competitive Local Exchange Telecommunications Services

5. Exchange Services

5.1 Exchange Areas

5.1.2 Incumbent Local Exchange Carrier Exchange Areas and Local Calling Areas (LCA)

A. Verizon Pennsylvania Inc. Exchange Areas and Local Calling Areas (Cont'd)

Exchange Area	Exchange, Zone or Wire Center Included in the Local Calling Area
Easton	Allentown, Bethlehem, Bloomsbury, NJ (Verizon – NJ), Catasauqua, Easton, Hellertown, Nazareth, Philipsburg, NJ (Verizon – NJ), Riegelsville, Springtown, Upper Black Eddy
Ebensburg	Carrolltown, Colver (Windstream), Cresson, Ebensburg, Nanty-Glo (Verizon North), Johnstown (Verizon North)
Eldred	Bradford, Duke Center (Armstrong North), Eldred, Port Allegheny, Rew, Smethport
Elizabeth	Clairton, Donora, Elizabeth, Monongahela, Pitb. Subn. Zone 10, Pitb. Subn. Zone 11
Ellwood City	Beaver Falls, Ellwood City, New Castle, Portersville (CenturyLink), Wampum, Zelienople
Elysburg	Catawissa, Danville, Elysburg, Kulpmont, Mt. Carmel, Numidia, Shamokin, Sunbury
Endeavor	Endeavor, Tidioute, Tionesta
Exton	Chester Springs, Coatesville, Downingtown, Eagle, Exton, Glenmoore, Lenape, Mortonville, Phila. Subn. Zone 28, Pughtown, West Chester, Westtown

EXHIBIT 4 - COMPETITIVE LOCAL EXCHANGE

CenturyTel Broadband Services, Inc.

Supplement No. 1

Telephone Pa. P.U.C. Tariff No. 1

Issued: August xx, 2021

Section 5

Effective: September yy, 2021

Original Page 11

Competitive Local Exchange Telecommunications Services

5. Exchange Services

5.1 Exchange Areas

5.1.2 Incumbent Local Exchange Carrier Exchange Areas and Local Calling Areas (LCA)

A. Verizon Pennsylvania Inc. Exchange Areas and Local Calling Areas (Cont'd)

Exchange Area	Exchange, Zone or Wire Center Included in the Local Calling Area
Fairchance	Fairchance, Masontown, McClellandtown, Point Marion, Smithfield, Uniontown
Farmington	Farmington, Uniontown
Fayette City	Belle Vernon, California, Charleroi, Fayette City, Monessen, Perryopolis
Finleyville	Finleyville, McMurray, Monongahela, Pitb. Subn. Zone 11, Pitb. Subn. Zone 12
Fleetwood	Fleetwood, Kutztown, Leesport (Commonwealth Tel.), Oley (The Conestoga Tel. and Tel. Co.), Reading, Topton (The Conestoga Tel. and Tel. Co.)
Frackville	Ashland, Frackville, Girardville, Mahanoy City, Minersville, Pottsville, Saint Clair, Shenandoah
Freeland	Freeland, Hazleton, McAdoo, Weatherly, White Haven
Frenchville	Clearfield, Frenchville, Philipsburg, Snow Shoe, Winburne
Galeton	Galeton
Girardville	Ashland, Frackville, Girardville, Mahanoy City, Shenandoah
Glen Campbell	Barnesboro, Cherry Tree, Glen Campbell

EXHIBIT 4 - COMPETITIVE LOCAL EXCHANGE

CenturyTel Broadband Services, Inc.

Supplement No. 1
Telephone Pa. P.U.C. Tariff No. 1
Section 5
Original Page 12

Issued: August xx, 2021
Effective: September yy, 2021

Competitive Local Exchange Telecommunications Services

5. Exchange Services

5.1 Exchange Areas

5.1.2 Incumbent Local Exchange Carrier Exchange Areas and Local Calling Areas (LCA)

A. Verizon Pennsylvania Inc. Exchange Areas and Local Calling Areas (Cont'd)

Exchange Area	Exchange, Zone or Wire Center Included in the Local Calling Area
Glenmoore	Chester Springs, Coatesville, Downingtown, Eagle, Exton, Green Hills (The Conestoga Tel. and Tel. Co.), Glenmoore, Honey Brook, Morgantown (The Conestoga Tel. and Tel. Co.), Parkesburg, Pughtown, West Chester
Glenwillard	Aliquippa, Ambridge, Glenwillard, Pitb. Subn. Zone 15, Pitb. Subn. Zone 16
Green Lane	Center Point, Collegeville, Green Lane, Harleysville, Lansdale, Pennsburg, Perkasie, Quakertown, Schwenksville, Souderton, Sassamansville (The Conestoga Tel. and Tel. Co.)
Greensburg	Delmont (Windstream), Greensburg, Herminie, Jeannette, Kecksburg (Citizens Tel. Co. of Kecksburg), Latrobe, New Alexandria (Windstream), Youngwood
Greenville	Greenville, Sharpsville, Sheakleyville (Windstream), Transfer (The Pymatuning Ind. Tel. Co.)
Grove City	Blacktown (CenturyLink), Grove City, Harrisville (CenturyLink), Mercer, Wesley (Verizon North)
Halifax	Dauphin, Elizabethville (Commonwealth Tel.), Halifax, Harrisburg Zone 1, Millersburg (Commonwealth Tel.)

EXHIBIT 4 - COMPETITIVE LOCAL EXCHANGE

CenturyTel Broadband Services, Inc.

Supplement No. 1
Telephone Pa. P.U.C. Tariff No. 1
Section 5
Original Page 13

Issued: August xx, 2021
Effective: September yy, 2021

Competitive Local Exchange Telecommunications Services

5. Exchange Services

5.1 Exchange Areas

5.1.2 Incumbent Local Exchange Carrier Exchange Areas and Local Calling Areas (LCA)

A. Verizon Pennsylvania Inc. Exchange Areas and Local Calling Areas (Cont'd)

Exchange Area	Exchange, Zone or Wire Center Included in the Local Calling Area
Hamburg	Hamburg, Kempton (Verizon North), Leesport (Commonwealth Tel.), Reading
Hamlin	Hamlin, Lake Ariel, Moscow, Newfoundland, Olyphant, Scranton, Wallenpaupack
Harleysville	Center Point, Collegeville, Green Lane, Harleysville, Lansdale, Line Lexington, North Wales, Perkasie, Phila. Subn. Zone 30, Schwenksville, Souderton
Harrisburg Zone 1	Dauphin, Halifax, Harrisburg Zone 1, Harrisburg Zone 2, Hershey (Verizon North), Hummelstown, Lewisberry (Commonwealth Tel.), Marysville (CenturyLink), Mechanicsburg, Middletown, Shellsville (Verizon North)
Harrisburg Zone 2	Harrisburg Zone 1, Harrisburg Zone 2, Hershey (Verizon North), Hummelstown, Middletown
Hastings	Barnesboro, Carrolltown, Hastings, Patton
Hawley	Hawley, Honesdale, Lords Valley, Newfoundland, Wallenpaupack
Hazleton	Conyngnam-Drums (Commonwealth Tel.), Freeland, Hazleton, McAdoo, Nuremburg (Commonwealth Tel.), Weatherly, White Haven

EXHIBIT 4 - COMPETITIVE LOCAL EXCHANGE

CenturyTel Broadband Services, Inc.

Supplement No. 1

Telephone Pa. P.U.C. Tariff No. 1

Issued: August xx, 2021

Section 5

Effective: September yy, 2021

Original Page 14

Competitive Local Exchange Telecommunications Services

5. Exchange Services

5.1 Exchange Areas

5.1.2 Incumbent Local Exchange Carrier Exchange Areas and Local Calling Areas (LCA)

A. Verizon Pennsylvania Inc. Exchange Areas and Local Calling Areas (Cont'd)

Exchange Area	Exchange, Zone or Wire Center Included in the Local Calling Area
Hellertown	Allentown, Bethlehem, Catasauqua, Easton, Hellertown, Riegelsville, Springtown
Herminie	Greensburg, Herminie, Jeannette, Pittb. Subn. Zone 23
Hollidaysburg	Altoona, Cresson, Hollidaysburg
Homer City	Black Lick, Blairsville, Homer City, Indiana
Honesdale	Beach Lake (Verizon North), Galilee (Verizon North), Hawley, Honesdale, Lake Ariel, Lords Valley, Pleasant Mount (The North-Eastern Pa. Tel. Co.), South Canaan (The South Canaan Tel. Co.), Wallenpaupack, Waymart (The South Canaan Tel. Co.)
Honey Brook	Coatesville, Downingtown, Glenmoore, Green Hills (The Conestoga Tel. and Tel. Co.), Honey Brook, Morgantown (The Conestoga Tel. and Tel. Co.), Parkesburg
Hookstown	Aliquippa, Beaver Falls, Chester, W. Va. (Verizon – W. Va.), East Liverpool, O. (AMERITECH, O.), Hookstown, Midland, Rochester, Smiths Ferry
Houtzdale	Clearfield, Houtzdale, Osceola Mills, Philipsburg

EXHIBIT 4 - COMPETITIVE LOCAL EXCHANGE

CenturyTel Broadband Services, Inc.

Supplement No. 1

Telephone Pa. P.U.C. Tariff No. 1

Issued: August xx, 2021

Section 5

Effective: September yy, 2021

Original Page 15

Competitive Local Exchange Telecommunications Services

5. Exchange Services

5.1 Exchange Areas

5.1.2 Incumbent Local Exchange Carrier Exchange Areas and Local Calling Areas (LCA)

A. Verizon Pennsylvania Inc. Exchange Areas and Local Calling Areas (Cont'd)

Exchange Area	Exchange, Zone or Wire Center Included in the Local Calling Area
Hummelstown	Harrisburg Zone 1, Harrisburg Zone 2, Hershey (Verizon North), Hummelstown, Middletown, Palmyra, Shellsville (Verizon North)
Huntingdon	Alexandria, Huntingdon, Marklesburg (CenturyLink), McConnellstown (CenturyLink), Mount Union
Imperial	Imperial, McDonald, Murdocksville (Armstrong), Oakdale, Pitb. Subn. Zone 14, Pitb. Subn. Zone 15
Indiana	Black Lick, Blairsville, Clymer, Elderton (Windstream), Homer City, Indiana, Marion Center, Parkwood
Jeannette	Greensburg, Harrison City (Windstream), Herminie, Jeannette, Pitb. Subn. Zone 23
Jermyn	Carbondale, Chapman Lake (Verizon North), Jermyn, Olyphant, Scranton
Jersey Shore	Avis, Jersey Shore, Lock Haven, Oval (Pennsylvania Tel. Co.), Williamsport, Woolrich
Jim Thorpe	Jim Thorpe, Lehighton, Nesquehoning, Weatherly, White Haven
Kane	Kane, Ludlow, Mount Jewett

EXHIBIT 4 - COMPETITIVE LOCAL EXCHANGE

CenturyTel Broadband Services, Inc.

Supplement No. 1
Telephone Pa. P.U.C. Tariff No. 1
Section 5
Original Page 16

Issued: August xx, 2021
Effective: September yy, 2021

Competitive Local Exchange Telecommunications Services

5. Exchange Services

5.1 Exchange Areas

5.1.2 Incumbent Local Exchange Carrier Exchange Areas and Local Calling Areas (LCA)

A. Verizon Pennsylvania Inc. Exchange Areas and Local Calling Areas (Cont'd)

Exchange Area	Exchange, Zone or Wire Center Included in the Local Calling Area
Kemblesville	Avondale, Kemblesville, Kennett Square, Landenberg, Mendenhall, Oxford, Unionville, West Grove, Hockessin, DE (Verizon – DE), Newark, DE (Verizon – DE)
Kennett Square	Avondale, Coatesville, Kemblesville, Kennett Square, Landenberg, Lenape, Mendenhall, Mortonville, Unionville, West Chester, West Grove, Westtown, Hockessin, DE (Verision – DE), Wilmington, DE (Verizon – DE)
Kingston	Center Moreland (Commonwealth Tel.), Dallas (Commonwealth Tel.), Harveys Lake (Commonwealth Tel.), Kingston, Mountaintop, Nanticoke, Pittston, Plymouth, Trucksville (Commonwealth Tel.), Wilkes-Barre, Wyoming
Kulpmont	Ashland, Elysburg, Kulpmont, Mount Carmel, Shamokin
Kutztown	Allentown, Fleetwood, Kempton (Verizon North), Kutztown, Reading, Topton (The Conestoga Tel. and Tel. Co.)
Lake Ariel	Hamlin, Honesdale, Lake Ariel, Newfoundland, Olyphant, Scranton, South Canaan (The South Canaan Tel. Co.), Wallenpaupack, Waymart (The South Canaan Tel. Co.)

EXHIBIT 4 - COMPETITIVE LOCAL EXCHANGE

CenturyTel Broadband Services, Inc.

Supplement No. 1

Telephone Pa. P.U.C. Tariff No. 1

Issued: August xx, 2021

Section 5

Effective: September yy, 2021

Original Page 17

Competitive Local Exchange Telecommunications Services

5. Exchange Services

5.1 Exchange Areas

5.1.2 Incumbent Local Exchange Carrier Exchange Areas and Local Calling Areas (LCA)

A. Verizon Pennsylvania Inc. Exchange Areas and Local Calling Areas (Cont'd)

Exchange Area	Exchange, Zone or Wire Center Included in the Local Calling Area
Lake Como	Lake Como
Lancaster	Intercourse (Frontier Comm. Of PA), Lancaster, Landisville, Leola (Frontier Comm. Of PA), Lititz (Denver & Ephrata Tel. and Tel. Co.), Manheim (Denver & Ephrata Tel. and Tel. Co.), Millersville, Mount Joy (CenturyLink), Mountville (CenturyLink), New Holland (Frontier Comm. Of PA), Quarryville (Commonwealth Tel.), Rawlinsville (Commonwealth Tel.), Strasburg
Landenberg	Avondale, Kemblesville, Kennett Square, Landenberg, Lanape, Mendenhall, Oxford, Unionville, West Chester, West Grove, Westtown, Hockessin, DE (Verizon – DE), Newark, DE (Verizon – DE), Wilmington, DE (Verizon – DE)
Landisville	Lancaster, Landisville, Lititz (Denver & Ephrata Tel. and Tel. Co.), Manheim (Denver & Ephrata Tel. and Tel. Co.), Millersville, Mount Joy (CenturyLink), Mountville (CenturyLink), Strasburg
Lansdale	Center Point, Harleysville, Lansdale, Line Lexington, North Wales, Souderton
Latrobe	Blairsville, Derry, Greensburg, Kecksburg (Citizens Tel. Co. of Kecksburg), Latrobe, Ligonier, New Alexandria (Windstream)

EXHIBIT 4 - COMPETITIVE LOCAL EXCHANGE

CenturyTel Broadband Services, Inc.

Supplement No. 1

Telephone Pa. P.U.C. Tariff No. 1

Issued: August xx, 2021

Section 5

Effective: September yy, 2021

Original Page 18

Competitive Local Exchange Telecommunications Services

5. Exchange Services

5.1 Exchange Areas

5.1.2 Incumbent Local Exchange Carrier Exchange Areas and Local Calling Areas (LCA)

A. Verizon Pennsylvania Inc. Exchange Areas and Local Calling Areas (Cont'd)

Exchange Area	Exchange, Zone or Wire Center Included in the Local Calling Area
Lebanon	Annville, Frytown (Verizon North), Hershey (Verizon North), Jonestown (Verizon North) Lebanon, Mt. Gretna, Myerstown (Verizon North), Palmyra, Schaefferstown (Verizon North)
Leeper	Clarion, Leeper, Marienville
Lehighton	Jim Thorpe, Lehighton, Nesquehoning, Palmerton (Palmerton Tel. Co.)
Lenape	Avondale, Coatesville, Downingtown, Exton, Kennett Square, Landenberg, Lenape, Mendenhall, Mortonville, Phila. Subn. Zone 10, Phila. Subn. Zone 28, Unionville, West Chester, West Grove, Westtown
Lewistown	Bellefonte (CenturyLink), Lewistown, McVeytown, Mifflintown (CenturyLink), Port Royal (CenturyLink), Reedsville (CenturyLink)
Ligonier	Latrobe, Ligonier, Stahlstown (Laurel Highland Tel. Co.)
Line Lexington	Doylestown, Dublin, Harleysville, Lansdale, Line Lexington, North Wales, Perkasie, Phila. Subn. Zone 45, Souderton
Lock Haven	Avis, Beech Creek (CenturyLink), Jersey Shore, Lock Haven, Mill Hall (CenturyLink), Woolrich

EXHIBIT 4 - COMPETITIVE LOCAL EXCHANGE

CenturyTel Broadband Services, Inc.

Supplement No. 1
Telephone Pa. P.U.C. Tariff No. 1
Section 5
Original Page 19

Issued: August xx, 2021
Effective: September yy, 2021

Competitive Local Exchange Telecommunications Services

5. Exchange Services

5.1 Exchange Areas

5.1.2 Incumbent Local Exchange Carrier Exchange Areas and Local Calling Areas (LCA)

A. Verizon Pennsylvania Inc. Exchange Areas and Local Calling Areas (Cont'd)

Exchange Area	Exchange, Zone or Wire Center Included in the Local Calling Area
Lords Valley	Bushkill, Cresco, Hawley, Honesdale, Lords Valley, Mount Pocono, Newfoundland, Stroudsburg, Wallenpaupack
Lowellville	Bessemer, Hubbard, O. (AMERITECH, O.), Lowellville, Lowellville, O. (AMERITECH, O.), New Castle, North Lima, O. (AMERITECH, O.), Youngstown, O. (AMERITECH, O.)
Ludlow	Kane, Ludlow
Mahaffey	Mahaffey, Curwensville
Mahanoy City	Frackville, Girardville, Lakewood (Frontier Comm. – Lakewood), Mahanoy City, Shenandoah, Tamaqua
Marchand	Marchand, Punxsutawney
Marienville	Leeper, Marienville
Marion Center	Indiana, Marion Center
Masontown	Fairchance, Masontown, McClellandtown, Point Marion, Smithfield, Uniontown
McAdoo	Freeland, Hazleton, McAdoo, Tamaqua, Weatherly

EXHIBIT 4 - COMPETITIVE LOCAL EXCHANGE

CenturyTel Broadband Services, Inc.

Supplement No. 1

Telephone Pa. P.U.C. Tariff No. 1

Issued: August xx, 2021

Section 5

Effective: September yy, 2021

Original Page 20

Competitive Local Exchange Telecommunications Services

5. Exchange Services

5.1 Exchange Areas

5.1.2 Incumbent Local Exchange Carrier Exchange Areas and Local Calling Areas (LCA)

A. Verizon Pennsylvania Inc. Exchange Areas and Local Calling Areas (Cont'd)

Exchange Area	Exchange, Zone or Wire Center Included in the Local Calling Area
McClellandtown	Fairchance, Masontown, McClellandtown, Smithfield, Uniontown
McDonald	Burgettstown, Canonsburg, Imperial, McDonald, Midway (Windstream), Oakdale, Pitb. Subn. Zone 13
McMurray	Canonsburg, Finleyville, McMurray, Pitb. Subn. Zone 12, Pitb. Subn. Zone 13
McVeytown	Lewistown, McVeytown
Mechanicsburg	Dillsburg (Verizon North), Harrisburg Zone 1, Lewisberry (Commonwealth Tel.), Mechanicsburg
Mendenhall	Avondale, Kemblesville, Kennett Square, Landenberg, Lenape, Mendenhall, Phila. Subn. Zone 10, Unionville, West Chester, West Grove, Westtown, Hockessin, DE (Verizon – DE), Wilmington, DE (Verizon – DE)
Mercer	Blacktown (CenturyLink), Fredonia (Windstream), Grove City, Mercer, Sharon, Sharpsville, Wesley (Verizon North)
Middletown	Elizabethtown (CenturyLink), Harrisburg Zone 1, Harrisburg Zone 2, Hershey (Verizon North), Hummelstown, Middletown

EXHIBIT 4 - COMPETITIVE LOCAL EXCHANGE

CenturyTel Broadband Services, Inc.

Supplement No. 1

Telephone Pa. P.U.C. Tariff No. 1

Issued: August xx, 2021

Section 5

Effective: September yy, 2021

Original Page 21

Competitive Local Exchange Telecommunications Services

5. Exchange Services

5.1 Exchange Areas

5.1.2 Incumbent Local Exchange Carrier Exchange Areas and Local Calling Areas (LCA)

A. Verizon Pennsylvania Inc. Exchange Areas and Local Calling Areas (Cont'd)

Exchange Area	Exchange, Zone or Wire Center Included in the Local Calling Area
Midland	Beaver Falls, Hookstown, Midland, Rochester, Smiths Ferry
Millersville	Lancaster, Landsville, Millersville, Mountville (CenturyLink), Strasburg
Millheim	Bellefonte, Boalsburg, Centre Hall, Millheim, Spring Mills, State College
Millville	Bloomsburg, Millville, Washingtonville
Milton	Lewisburg (Buffalo Valley Tel. Co.), Mifflinburg (Buffalo Valley Tel. Co.), Milton, Northumberland, Sunbury, Washingtonville, Watsonstown (Windstream)
Minersville	Frackville, Minersville, New Philadelphia, Orwigsburg, Pottsville, Saint Clair, Schuylkill Haven, Tremont (Commonwealth Tel.)
Monessen	Belle Vernon, Charleroi, Donora, Fayette City, Monessen, Monongahela
Monongahela	Belle Vernon, Charleroi, Donora, Elizabeth, Finleyville, Monessen, Monongahela

EXHIBIT 4 - COMPETITIVE LOCAL EXCHANGE

CenturyTel Broadband Services, Inc.

Supplement No. 1

Telephone Pa. P.U.C. Tariff No. 1

Issued: August xx, 2021

Section 5

Effective: September yy, 2021

Original Page 22

Competitive Local Exchange Telecommunications Services

5. Exchange Services

5.1 Exchange Areas

5.1.2 Incumbent Local Exchange Carrier Exchange Areas and Local Calling Areas (LCA)

A. Verizon Pennsylvania Inc. Exchange Areas and Local Calling Areas (Cont'd)

Exchange Area	Exchange, Zone or Wire Center Included in the Local Calling Area
Moosic	Moosic, Pittston, Scranton, Taylor, Wyoming
Morrisville	Ewing, NJ (Verizon - NJ), Morrisville, Newtown, Phila. Subn. Zone 42, Phila. Subn. Zone 43, Phila, Subn. Zone 44, Trenton, NJ (Verizon - NJ), Yardley
Mortonville	Avondale, Coatesville, Downingtown, Exton, Kennett Square, Lenape, Mortonville, Parkesburg, Unionville, West Chester, West Grove, Westtown
Moscow	Hamlin, Moscow, Newfoundland, Scranton, Wallenpaupack
Mountaintop	Kingston, Mountaintop, Nanticoke, Nuangola (Commonwealth Tel.), Plymouth, Wilkes-Barre
Mount Carmel	Ashland, Elysburg, Kulpmont, Mount Carmel, Shamokin
Mount Gretna	Annville, Lebanon, Mount Gretna, Palmyra
Mount Jewett	Bradford, Mount Jewett, Kane
Mount Pleasant	Connellsville, Greensburg, Kecksburg (Citizens Tel. Co. of Kecksburg), Mount Pleasant, Scottdale, Youngwood

EXHIBIT 4 - COMPETITIVE LOCAL EXCHANGE

CenturyTel Broadband Services, Inc.

Supplement No. 1

Telephone Pa. P.U.C. Tariff No. 1

Issued: August xx, 2021

Section 5

Effective: September yy, 2021

Original Page 23

Competitive Local Exchange Telecommunications Services

5. Exchange Services

5.1 Exchange Areas

5.1.2 Incumbent Local Exchange Carrier Exchange Areas and Local Calling Areas (LCA)

A. Verizon Pennsylvania Inc. Exchange Areas and Local Calling Areas (Cont'd)

Exchange Area	Exchange, Zone or Wire Center Included in the Local Calling Area
Mount Pocono	Cresco, Lords Valley, Mount Pocono, Newfoundland, Stroudsburg
Mount Union	Huntingdon, McConnellstown (CenturyLink), Mount Union
Nanticoke	Kingston, Mountaintop, Nanticoke, Nuangola (Commonwealth Tel.), Plymouth, Wilkes-Barre
Nazareth	Allentown, Bath, Bethlehem, Catasauqua, Easton, Nazareth
Nesquehoning	Jim Thorpe, Lansford (Windstream), Lehighon, Nesquehoning
New Castle	Bessemer, Ellwood City, New Bedford (Verizon North), New Castle, New Wilmington (Verizon North), Plain Grove (CenturyLink), Princeton (Verizon North), Volant (CenturyLink), Wampum
New Florence	Bolivar, Johnstown, New Florence, Seward
Newfoundland	Cresco, Hamlin, Hawley, Lake Ariel, Lords Valley, Moscow, Mount Pocono, Newfoundland, Wallenpaupack
New Hope	Buckingham, Carversville, Doylestown, Lambertville, NJ (Verizon – NJ), New Hope, Newtown, Plumsteadville, Wycombe, Yardley

EXHIBIT 4 - COMPETITIVE LOCAL EXCHANGE

CenturyTel Broadband Services, Inc.

Supplement No. 1
Telephone Pa. P.U.C. Tariff No. 1
Section 5
Original Page 24

Issued: August xx, 2021
Effective: September yy, 2021

Competitive Local Exchange Telecommunications Services

5. Exchange Services

5.1 Exchange Areas

5.1.2 Incumbent Local Exchange Carrier Exchange Areas and Local Calling Areas (LCA)

A. Verizon Pennsylvania Inc. Exchange Areas and Local Calling Areas (Cont'd)

Exchange Area	Exchange, Zone or Wire Center Included in the Local Calling Area
New Kensington	New Kensington, Pitb. Subn. Zone 20, Springdale, Tarentum
New Philadelphia	Minersville, New Philadelphia, Orwigsburg, Pottsville, Saint Clair, Schuylkill Haven, Tamaqua
New Salem	Brownsville, New Salem, Republic, Uniontown
Newtown	Newtown, Phila. Subn. Zone 40, Phila. Subn. Zone 43, Wycombe, Yardley
North Wales	Center Point, Harleysville, Lansdale, Line Lexington, North Wales, Phila. Subn. Zone 30, Phila. Subn. Zone 33, Souderton
Northampton	Allentown, Bath, Bethlehem, Catasauqua, Ironton (Ironton Tel. Co.), Northampton, Slatington
Northumberland	Danville, Milton, Northumberland, Sunbury
Numidia	Bloomsburg, Catawissa, Elysburg, Numidia
Oakdale	Imperial, McDonald, Oakdale, Pitb. Subn. Zone 13, Pitb. Subn. Zone 14
Olyphant	Carbondale, Chapman Lake (Verizon North), Hamlin, Jermyn, Lake Ariel, Olyphant, Scranton, Taylor

EXHIBIT 4 - COMPETITIVE LOCAL EXCHANGE

CenturyTel Broadband Services, Inc.

Supplement No. 1

Telephone Pa. P.U.C. Tariff No. 1

Issued: August xx, 2021

Section 5

Effective: September yy, 2021

Original Page 25

Competitive Local Exchange Telecommunications Services

5. Exchange Services

5.1 Exchange Areas

5.1.2 Incumbent Local Exchange Carrier Exchange Areas and Local Calling Areas (LCA)

A. Verizon Pennsylvania Inc. Exchange Areas and Local Calling Areas (Cont'd)

Exchange Area	Exchange, Zone or Wire Center Included in the Local Calling Area
Orwigsburg	Auburn (Verizon North), Minersville, New Philadelphia, Orwigsburg, Pottsville, Saint Clair, Schuylkill Haven
Osceola Mills	Clearfield, Houtzdale, Osceola Mills, Philipsburg
Oxford	Avondale, Kemblesville, Kirkwood (Commonwealth Tel.), Landenberg, Oxford, West Grove
Palmyra	Annville, Harrisburg Zone 1, Hershey (Verizon North), Hummelstown, Lebanon, Mount Gretna, Palmyra
Paris	Burgettstown, Paris, Weirton, W. Va. (Verizon – W. Va.)
Parquesburg	Atglen (Commonwealth Tel.), Coatesville, Gap (Commonwealth Tel.), Glenmoore, Honey Brook, Mortonville, Parkesburg, West Grove
Parkwood	Indiana, Parkwood
Patton	Altoona, Barnesboro, Carrolltown, Hastings, Patton
Pennsburg	Bally (The Conestoga Tel. and Tel. Co.), Green Lane, Pennsburg, Perkasio, Quakertown, Sassamansville (The Conestoga Tel. and Tel. Co.), Souderton

EXHIBIT 4 - COMPETITIVE LOCAL EXCHANGE

CenturyTel Broadband Services, Inc.

Supplement No. 1

Telephone Pa. P.U.C. Tariff No. 1

Issued: August xx, 2021

Section 5

Effective: September yy, 2021

Original Page 26

Competitive Local Exchange Telecommunications Services

5. Exchange Services

5.1 Exchange Areas

5.1.2 Incumbent Local Exchange Carrier Exchange Areas and Local Calling Areas (LCA)

A. Verizon Pennsylvania Inc. Exchange Areas and Local Calling Areas (Cont'd)

Exchange Area	Exchange, Zone or Wire Center Included in the Local Calling Area
Perkasie	Bedminster, Doylestown, Dublin, Green Lane, Harleysville, Lansdale, Line Lexington, Pennsburg, Perkasie, Plumsteadville, Quakertown, Schwenksville, Souderton
Perryopolis	Belle Vernon, Dawson, Fayette City, Perryopolis, Uniontown
Philadelphia Zone 1	Phila. Zone 1, Phila. Zone 2, Phila. Zone 3, Phila. Zone 4
Philadelphia Zone 2	Phila. Zone 1, Phila. Zone 2, Phila. Zone 3, Phila. Zone 4, Phila. Sub. Zone 14, Phila. Sub. Zone 17, Phila. Sub. Zone 21, Phila. Sub. Zone 23, Phila. Sub. Zone 24
Philadelphia Zone 3	Phila. Zone 1, Phila. Zone 2, Phila. Zone 3, Phila. Zone 4, Phila. Sub. Zone 23, Phila. Sub. Zone 31, Phila. Sub. Zone 32, Phila. Sub. Zone 34
Philadelphia Zone 4	Phila. Zone 1, Phila. Zone 2, Phila. Zone 3, Phila. Zone 4, Phila. Sub. Zone 34, Phila. Sub. Zone 37, Phila. Sub. Zone 40, Phila. Sub. Zone 41
Chester Heights (Phil. Suburban Zone 10)	Chester, Chester Heights, Holly Oak, DE (Verizon – DE), Lenape, Media, Mendenhall, West Chester, Westtown, Wilmington, DE (Verizon – DE)

EXHIBIT 4 - COMPETITIVE LOCAL EXCHANGE

CenturyTel Broadband Services, Inc.

Supplement No. 1
Telephone Pa. P.U.C. Tariff No. 1
Section 5
Original Page 27

Issued: August xx, 2021
Effective: September yy, 2021

Competitive Local Exchange Telecommunications Services

5. Exchange Services

5.1 Exchange Areas

5.1.2 Incumbent Local Exchange Carrier Exchange Areas and Local Calling Areas (LCA)

A. Verizon Pennsylvania Inc. Exchange Areas and Local Calling Areas (Cont'd)

Exchange Area	Exchange, Zone or Wire Center Included in the Local Calling Area
Chester (Phil. Suburban Zone 11)	Chester, Chester Heights, Darby-Ridley Park-Sharon Hill, Holly Oak, DE (Verizon – DE), Media, Swarthmore
Media (Phil. Suburban Zone 12)	Broomall-Newton Square, Chester, Chester Heights, Media, Swarthmore
Swarthmore (Phil. Suburban Zone 13)	Broomall-Newton Square, Chester, Darby-Ridley Park-Sharon Hill, Havertown-Manoa, Media, Swarthmore, Upper Darby
Darby-Ridley Park-Sharon Hill (Phil. Suburban Zone 14)	Chester, Darby-Ridley Park-Sharon Hill, Phila. Zone 2, Swarthmore, Upper Darby
Upper Darby (Phil. Suburban Zone 17)	Darby-Ridley Park-Sharon Hill, Havertown-Manoa, Phila. Zone 2, Swarthmore, Upper Darby
Havertown-Manoa (Phil. Suburban Zone 21)	Ardmore, Broomall-Newton Square, Havertown-Manoa, Phila. Zone 2, Swarthmore, Upper Darby
Broomall-Newton Square (Phil. Suburban Zone 22)	Ardmore, Broomall-Newton Square, Bryn Mawr, Havertown-Manoa, Media, Paoli-Malvern-Berwyn, Swarthmore, Wayne
Cynwyd-Narberth (Phil. Suburban Zone 23)	Ardmore, Bryn Mawr, Cynwyd-Narberth, Phila. Zone 2, Phila. Zone 3
Ardmore (Phil. Suburban Zone 24)	Ardmore, Broomall-Newton Square, Bryn Mawr, Conshohocken, Cynwyd-Narberth, Havertown-Manoa, Phila. Zone 2, Wayne

EXHIBIT 4 - COMPETITIVE LOCAL EXCHANGE

CenturyTel Broadband Services, Inc.

Supplement No. 1

Telephone Pa. P.U.C. Tariff No. 1

Issued: August xx, 2021

Section 5

Effective: September yy, 2021

Original Page 28

Competitive Local Exchange Telecommunications Services

5. Exchange Services

5.1 Exchange Areas

5.1.2 Incumbent Local Exchange Carrier Exchange Areas and Local Calling Areas (LCA)

A. Verizon Pennsylvania Inc. Exchange Areas and Local Calling Areas (Cont'd)

Exchange Area	Exchange, Zone or Wire Center Included in the Local Calling Area
Bryn Mawr (Phil. Suburban Zone 25)	Ardmore, Broomall-Newton Square, Bryn Mawr, Conshohocken, Cynwyd-Narberth, Wayne
Wayne (Phil. Suburban Zone 26)	Ardmore, Broomall-Newton Square, Bryn Mawr, Conshohocken, Norristown, Paoli-Malvern-Berwyn, Valley Forge, Wayne
Paoli-Malvern-Berwyn (Phil. Suburban Zone 28)	Broomall-Newton Square, Chester Springs, Downingtown, Eagle, Exton, Lenape, Paoli-Malvern-Berwyn, Phoenixville, Valley Forge, Wayne, West Chester, Westtown
Valley Forge (Phil. Suburban Zone 29)	Collegeville, Norristown, Paoli-Malvern-Berwyn, Phoenixville, Royersford, Valley Forge, Wayne
Norristown (Phil. Suburban Zone 30)	Ambler, Center Point, Collegeville, Conshohocken, Harleysville, Lansdale, Norristown, North Wales, Phoenixville, Royersford, Schwenksville, Valley Forge, Wayne
Conshohocken (Phil. Suburban Zone 31)	Ambler, Ardmore, Bryn Mawr, Center Point, Collegeville, Conshohocken, Flourtown, Norristown, Phila. Zone 3, Wayne
Flourtown (Phil. Suburban Zone 32)	Ambler, Cheltenham-Elkins Park-Jenkintown, Conshohocken, Flourtown, Phila. Zone 3

EXHIBIT 4 - COMPETITIVE LOCAL EXCHANGE

CenturyTel Broadband Services, Inc.

Supplement No. 1

Telephone Pa. P.U.C. Tariff No. 1

Issued: August xx, 2021

Section 5

Effective: September yy, 2021

Original Page 29

Competitive Local Exchange Telecommunications Services

5. Exchange Services

5.1 Exchange Areas

5.1.2 Incumbent Local Exchange Carrier Exchange Areas and Local Calling Areas (LCA)

A. Verizon Pennsylvania Inc. Exchange Areas and Local Calling Areas (Cont'd)

Exchange Area	Exchange, Zone or Wire Center Included in the Local Calling Area
Ambler (Phil. Suburban Zone 33)	Ambler, Cheltenham-Elkins Park-Jenkintown, Conshohocken, Flourtown, Hatboro, Norristown, North Wales, Warrington, Willow Grove
Cheltenham-Elkins Park-Jenkintown (Phil. Suburban Zone 34)	Ambler, Bethayres-Huntingdon, Cheltenham-Elkins Park-Jenkintown, Flourtown, Hatboro, North Wales, Phila. Zone 3, Phila. Zone 4, Willow Grove
Bethayres-Huntingdon (Phil. Suburban Zone 37)	Bethayres-Huntingdon, Cheltenham-Elkins Park-Jenkintown, Feasterville-Churchville, Hatboro, Phila. Zone 4, Warrington, Willow Grove
Willow Grove (Phil. Suburban Zone 38)	Ambler, Bethayres-Huntingdon, Cheltenham-Elkins Park-Jenkintown, Feasterville-Churchville, Hatboro, Warrington, Willow Grove
Hatboro (Phil. Suburban Zone 39)	Ambler, Bethayres-Huntingdon, Cheltenham-Elkins Park-Jenkintown, Feasterville-Churchville, Hatboro, Warrington, Willow Grove
Feasterville-Churchville (Phil. Suburban Zone 40)	Bethayres-Huntingdon, Eddington-Cornwells Heights, Feasterville-Churchville, Hatboro, Langhorne, Newtown, Phila. Zone 4, Warrington, Willow Grove, Wycombe
Eddington-Cornwells Heights (Phil. Suburban Zone 41)	Bristol, Eddington-Cornwells Heights, Feasterville-Churchville, Langhorne, Phila. Zone 4

EXHIBIT 4 - COMPETITIVE LOCAL EXCHANGE

CenturyTel Broadband Services, Inc.

Supplement No. 1

Telephone Pa. P.U.C. Tariff No. 1

Issued: August xx, 2021

Section 5

Effective: September yy, 2021

Original Page 30

Competitive Local Exchange Telecommunications Services

5. Exchange Services

5.1 Exchange Areas

5.1.2 Incumbent Local Exchange Carrier Exchange Areas and Local Calling Areas (LCA)

A. Verizon Pennsylvania Inc. Exchange Areas and Local Calling Areas (Cont'd)

Exchange Area	Exchange, Zone or Wire Center Included in the Local Calling Area
Bristol (Phil. Suburban Zone 42)	Bristol, Eddington-Cornwells Heights, Langhorne, Levittown, Morrisville, Yardley
Langhorne (Phil. Suburban Zone 43)	Bristol, Eddington-Cornwells Heights, Feasterville- Churchville, Langhorne, Levittown, Morrisville, Newtown, Yardley
Levittown (Phil. Suburban Zone 44)	Bristol, Langhorne, Levittown, Morrisville, Newtown, Yardley
Warrington (Phil. Suburban Zone 45)	Ambler, Bethayres-Huntingdon, Buckingham, Doylestown, Feasterville-Churchville, Hatboro, Line Lexington, Warrington, Willow Grove, Wycombe
Philipsburg	Clearfield, Frenchville, Houtzdale, Osceola Mills, Philipsburg, Winburne
Phoenixville	Chester Springs, Collegeville, Eagle, Phila. Subn. Zone 28, Phila. Subn. Zone 29, Phoenixville, Pughtown, Royersford
<u>Pittsburgh Exchange Areas</u>	
Bellevue (Includes West View)	Bellevue, Braddock, Carrick, Coraopolis, Crafton, East Liberty, Homestead, Millvale, Perrysville, Pittsburgh
Braddock (Includes Wilkinsburg)	Bellevue, Braddock, Carrick, Crafton, East Liberty, Homestead, Millvale, Monroeville, Penn Hills, Pittsburgh

EXHIBIT 4 - COMPETITIVE LOCAL EXCHANGE

CenturyTel Broadband Services, Inc.

Supplement No. 1

Telephone Pa. P.U.C. Tariff No. 1

Issued: August xx, 2021

Section 5

Effective: September yy, 2021

Original Page 31

Competitive Local Exchange Telecommunications Services

5. Exchange Services

5.1 Exchange Areas

5.1.2 Incumbent Local Exchange Carrier Exchange Areas and Local Calling Areas (LCA)

A. Verizon Pennsylvania Inc. Exchange Areas and Local Calling Areas (Cont'd)

Exchange Area	Exchange, Zone or Wire Center Included in the Local Calling Area
Carrick (Includes Mt. Lebanon)	Bellevue, Bethel Park, Braddock, Bridgeville, Carnegie, Carrick, Crafton, East Liberty, Homestead, Millvale, Pittsburgh, Pleasant Hills
Crafton (Includes McKees Rocks)	Bellevue, Braddock, Carnegie, Carrick, Coraopolis, Crafton, East Liberty, Homestead, Millvale, Pittsburgh
East Liberty	Bellevue, Braddock, Carrick, Crafton, East Liberty, Fox Chapel, Homestead, Millvale, Oakmont, Pittsburgh
Homestead	Bellevue, Braddock, Carrick, Crafton, East Liberty, Homestead, McKeesport, Millvale, Pittsburgh, Pleasant Hills
Millvale (Includes Sharpsburg)	Bellevue, Braddock, Carrick, Crafton, East Liberty, Fox Chapel, Glenshaw, Homestead, Millvale, Oakmont, Pittsburgh
Pittsburgh	Aliquippa, Ambridge, Bellevue, Braddock, Canonsburg, Carrick, Clariton, Crafton, East Liberty, Elizabeth, Export, Glenwillard, Harrison City, Homestead, Imperial, McDonald, McMurray, Millvale, New Kingston,, Oakdale, Pittsburgh, Springdale, Tarentum,
Bethel Park (Pitt. Sub. 12)	Bethel Park, Bridgeville, Carrick, Finleyville, McMurray, Pleasant Hills
Bridgeville (Pitt. Sub. 13)	Bethel Park, Bridgeville, Canonsburg, Carnegie, Carrick, McDonald, McMurray, Oakdale

EXHIBIT 4 - COMPETITIVE LOCAL EXCHANGE

CenturyTel Broadband Services, Inc.

Supplement No. 1
Telephone Pa. P.U.C. Tariff No. 1
Section 5
Original Page 32

Issued: August xx, 2021
Effective: September yy, 2021

Competitive Local Exchange Telecommunications Services

5. Exchange Services

5.1 Exchange Areas

5.1.2 Incumbent Local Exchange Carrier Exchange Areas and Local Calling Areas (LCA)

A. Verizon Pennsylvania Inc. Exchange Areas and Local Calling Areas (Cont'd)

Exchange Area	Exchange, Zone or Wire Center Included in the Local Calling Area
Carnegie (Pitt. Sub. 14)	Bridgeville, Carnegie, Carrick, Coraopolis, Crafton, Imperial, Oakdale
Coraopolis (Pitt. Sub. 15)	Coraopolis, Carnegie, Sewickley, Bellevue, West View, Crafton, McKees Rocks, Ambridge, Glenwillard, Imperial
Fox Chapel (Includes Dorseyville) (Pitt. Sub. 19)	East Liberty, Fox Chapel, Glenshaw, Millvale, Oakmont, Springdale
Glenshaw (Pitt. Sub. 18)	Fox Chapel, Glenshaw, Millvale, Perrysville
Irwin (Pitt. Sub. 23)	Irwin, McKees Rocks, Monroeville, Greensburg, Harrison City (Windstream), Hermine, Jeannette
McKeesport (Pitt. Sub. 10)	McKeesport, Pleasant Hills, Bethel Park, Monroeville, Irwin, Clairton, Elizabeth, Homestead
Monroeville (Includes Turtle Creek) (Pitt. Sub. 22)	Braddock, Export, Harrison City, Irwin, McKeesport, Monroeville, Penn Hills
Oakmont (Pitt. Sub. 20)	East Liberty, Fox Chapel, Millvale, New Kensington, Oakmont, Penn Hills, Springdale, Tarentum

EXHIBIT 4 - COMPETITIVE LOCAL EXCHANGE

CenturyTel Broadband Services, Inc.

Supplement No. 1
Telephone Pa. P.U.C. Tariff No. 1
Section 5
Original Page 33

Issued: August xx, 2021
Effective: September yy, 2021

Competitive Local Exchange Telecommunications Services

5. Exchange Services

5.1 Exchange Areas

5.1.2 Incumbent Local Exchange Carrier Exchange Areas and Local Calling Areas (LCA)

A. Verizon Pennsylvania Inc. Exchange Areas and Local Calling Areas (Cont'd)

Exchange Area	Exchange, Zone or Wire Center Included in the Local Calling Area
Penn Hills (Pitt. Sub. 21)	Braddock, Export, Monroeville, Oakmont, Penn Hills
Perrysville (Pitt. Sub. 17)	Bellevue, Glenshaw, Perrysville, Wexford
Pleasant Hills (Pitt. Sub. 11)	Bethel Park, Carrick, Clairton, Elizabeth, Homestead, McKeesport, Pleasant Hills
Sewickley (Pitt. Sub. 16)	Sewickley, Coraopolis, Ambridge, Aliquippa, Glenwillard
Pittston	Harding (Commonwealth Tel.), Kingston, Moosic, Pittston, Scranton, Taylor, Wilkes-Barre, Wyoming
Plumsteadville	Bedminster, Buckingham, Carversville, Doylestown, Dublin, Ferndale (Commonwealth Tel.), Line Lexington, New Hope, Perkasio, Plumsteadville, Quakertown
Plymouth	Kingston, Mountaintop, Nanticoke, Plymouth, Wilkes- Barre
Point Marion	Cheat Lake (Verizon – W. Va.), Fairchance, Masontown, Point Marion, Morgantown, W. Va. (Verizon – W. Va.), Smithfield, Uniontown
Port Allegany	Eldred, Port Allegany, Roulette, Smethport

EXHIBIT 4 - COMPETITIVE LOCAL EXCHANGE

CenturyTel Broadband Services, Inc.

Supplement No. 1
Telephone Pa. P.U.C. Tariff No. 1
Section 5
Original Page 34

Issued: August xx, 2021
Effective: September yy, 2021

Competitive Local Exchange Telecommunications Services

5. Exchange Services

5.1 Exchange Areas

5.1.2 Incumbent Local Exchange Carrier Exchange Areas and Local Calling Areas (LCA)

A. Verizon Pennsylvania Inc. Exchange Areas and Local Calling Areas (Cont'd)

Exchange Area	Exchange, Zone or Wire Center Included in the Local Calling Area
Portage	Cresson, Ebensburg, Johnston, Portage, Southfork
Pottstown	Boyertown (The Conestoga Tel. and Tel. Co.), Collegeville, Douglassville (The Conestoga Tel. and Tel. Co.), Phoenixville, Pottstown, Pughtown, Royersford, Sassmansville (The Conestoga Tel. and Tel. Co.), Schwenksville
Pottsville	Auburn, Frackville, Friedensburg, Minersville, New Philadelphia, Orwigsburg, Pottsville, Schuylkill Haven, Saint Clair, Tamaqua
Pughtown	Chester Springs, Downingtown, Eagle, Exton, Glenmoore, Green Hills (The Conestoga Tel. and Tel. Co.), Morgantown (The Conestoga Tel. and Tel. Co.), Phoenixville, Pottstown, Pughtown, Royersford
Punxsutawney	Big Run, Marchand, Punxsutawney
Quakertown	Bedminster, Dublin, Ferndale (Commonwealth Tel.), Green Lane, Pennsburg, Perkasio, Plumsteadville, Quakertown, Souderton, Springtown

EXHIBIT 4 - COMPETITIVE LOCAL EXCHANGE

CenturyTel Broadband Services, Inc.

Supplement No. 1
Telephone Pa. P.U.C. Tariff No. 1
Section 5
Original Page 35

Issued: August xx, 2021
Effective: September yy, 2021

Competitive Local Exchange Telecommunications Services

5. Exchange Services

5.1 Exchange Areas

5.1.2 Incumbent Local Exchange Carrier Exchange Areas and Local Calling Areas (LCA)

A. Verizon Pennsylvania Inc. Exchange Areas and Local Calling Areas (Cont'd)

Exchange Area	Exchange, Zone or Wire Center Included in the Local Calling Area
Reading	Adamstown (Denver & Ephrata Tel. and Tel. Co.), Bernville (Verizon – North), Birdsboro (The Conestoga Tel. and Tel. Co.), Fleetwood, Green Hills (The Conestoga Tel. and Tel. Co.), Hamburg, Kutztown, Leesport (Commonwealth Tel.), Morgantown (The Conestoga Tel. and Tel. Co.), Oley (The Conestoga Tel. and Tel. Co.), Reading, Robesonia (Verizon – North), Topton (The Conestoga Tel. and Tel. Co.), Womelsdorf (Verizon – North), Yellow House (The Conestoga Tel. and Tel. Co.)
Renovo	Renovo
Republic	Brownsville, New Salem, Republic, Uniontown
Rew	Bradford, Duke Center (Armstrong North), Eldred, Limestone, NY (Verizon – NY), Rew, Smethport
Reynoldsville	DuBois, Reynoldsville, Sykesville
Riegelsville	Allentown, Bethlehem, Catasauqua, Easton, Ferndale (Commonwealth Tel.), Hellertown, Milford, NJ (Verizon – NJ), Philipsburg, NJ (Verizon – NJ), Riegelsville, Springtown, Upper Black Eddy
Rochester	Aliquippa, Ambridge, Baden, Beaver Falls, Hookstown, Midland, Rochester

EXHIBIT 4 - COMPETITIVE LOCAL EXCHANGE

CenturyTel Broadband Services, Inc.

Supplement No. 1
Telephone Pa. P.U.C. Tariff No. 1
Section 5
Original Page 36

Issued: August xx, 2021
Effective: September yy, 2021

Competitive Local Exchange Telecommunications Services

5. Exchange Services

5.1 Exchange Areas

5.1.2 Incumbent Local Exchange Carrier Exchange Areas and Local Calling Areas (LCA)

A. Verizon Pennsylvania Inc. Exchange Areas and Local Calling Areas (Cont'd)

Exchange Area	Exchange, Zone or Wire Center Included in the Local Calling Area
Roulette	Coudersport, Port Allegany, Roulette
Royersford	Center Point, Chester Springs, Collegeville, Eagle, Phila. Subn. Zone 29, Phila. Subn. Zone 30, Phoenixville, Pottstown, Pughtown, Royersford, Schwenksville
Russell	Russell, Sugar Grove, Warren, Youngsville
Saint Clair	Frackville, Minersville, New Philadelphia, Orwigsburg, Pottsville, Saint Clair, Schuylkill Haven
Saxton	Hopewell (CenturyLink), Saxton
Schuylkill Haven	Auburn (Verizon North), Friedensburg (Verizon North), Minersville, New Philadelphia, Orwigsburg, Pottsville, Saint Clair, Schuylkill Haven
Schwenksville	Center Point, Collegeville, Green Lane, Harleysville, Lansdale, Perkasio, Phila. Subn. Zone 30, Pottstown, Royersford, Sassamansville (The Conestoga Tel. and Tel. Co.), Schwenksville, Souderton
Scottdale	Connellsville, Dawson, Mount Pleasant, Scottdale

EXHIBIT 4 - COMPETITIVE LOCAL EXCHANGE

CenturyTel Broadband Services, Inc.

Supplement No. 1

Telephone Pa. P.U.C. Tariff No. 1

Issued: August xx, 2021

Section 5

Effective: September yy, 2021

Original Page 37

Competitive Local Exchange Telecommunications Services

5. Exchange Services

5.1 Exchange Areas

5.1.2 Incumbent Local Exchange Carrier Exchange Areas and Local Calling Areas (LCA)

A. Verizon Pennsylvania Inc. Exchange Areas and Local Calling Areas (Cont'd)

Exchange Area	Exchange, Zone or Wire Center Included in the Local Calling Area
Scranton	Clarks Summit (Commonwealth Tel.), Dalton (Commonwealth Tel.), Factoryville (Commonwealth Tel.), Hamlin, Jermyn, Lake Ariel, Lake Winola (Commonwealth Tel.), Moosic, Moscow, Olyphant, Pittston, Scranton, Taylor, Wyoming
Shamokin	Elysburg, Kulpmont, Mount Carmel, Shamokin, Sunbury, Trevorton (TDS – Mahanoy and Mahantango Tel. Co.)
Sharon	Mercer, Sharon, O. (AMERITECH, O.), Sharon, PA, Sharpsville, Transfer (The Pymatuning Ind. Tel. Co.), West Middlesex
Sharpsville	Greenville, Mercer, Sharon, O. (AMERITECH, O.), Sharon, PA, Sharpsville, Transfer (The Pymatuning Ind. Tel. Co.), West Middlesex
Shenandoah	Ashland, Frackville, Girardsville, Mahanoy City, Ringtown (Commonwealth Tel.), Shenandoah
Slatington	Allentown, Bath, Bethlehem, Catasauqua, Ironton (Ironton Tel. Co.), New Tripoli (Verizon North), Northampton, Slatington
Smethport	Bradford, Eldred, Port Allegany, Rew, Smethport

EXHIBIT 4 - COMPETITIVE LOCAL EXCHANGE

CenturyTel Broadband Services, Inc.

Supplement No. 1

Telephone Pa. P.U.C. Tariff No. 1

Issued: August xx, 2021

Section 5

Effective: September yy, 2021

Original Page 38

Competitive Local Exchange Telecommunications Services

5. Exchange Services

5.1 Exchange Areas

5.1.2 Incumbent Local Exchange Carrier Exchange Areas and Local Calling Areas (LCA)

A. Verizon Pennsylvania Inc. Exchange Areas and Local Calling Areas (Cont'd)

Exchange Area	Exchange, Zone or Wire Center Included in the Local Calling Area
Smithfield	Fairchance, Masontown, McClellandtown, Point Marion, Smithfield, Uniontown
Smiths Ferry	Chester, W. Va. (Verizon – W. Va.), East Liverpool, O. (AMERITECH, O.), Hookstown, Midland, Rochester, Smiths Ferry
Smock	Brownsville, Smock, Uniontown
Snow Shoe	Bellefonte, Frenchville, Snow Shoe
Souderton	Center Point, Collegeville, Doylestown, Dublin, Green Lane, Harleysville, Lansdale, Line Lexington, North Wales, Pennsburg, Perkasio, Quakertown, Schwenksville, Souderton
Springdale	New Kensington, Pitb. Subn. Zone 19, Pitb. Subn. Zone 20, Springdale, Tarentum
Spring Mills	Bellefonte, Boalsburg, Centre Hall, Millheim, Spring Mills, State College
Springtown	Allentown, Bethlehem, Catasauqua, Easton, Ferndale (Commonwealth Tel.), Hellertown, Milford, NJ (Verizon – NJ), Quakertown, Riegelsville, Springtown, Upper Black Eddy

EXHIBIT 4 - COMPETITIVE LOCAL EXCHANGE

CenturyTel Broadband Services, Inc.

Supplement No. 1
Telephone Pa. P.U.C. Tariff No. 1
Section 5
Original Page 39

Issued: August xx, 2021
Effective: September yy, 2021

Competitive Local Exchange Telecommunications Services

5. Exchange Services

5.1 Exchange Areas

5.1.2 Incumbent Local Exchange Carrier Exchange Areas and Local Calling Areas (LCA)

A. Verizon Pennsylvania Inc. Exchange Areas and Local Calling Areas (Cont'd)

Exchange Area	Exchange, Zone or Wire Center Included in the Local Calling Area
State College	Bellefonte, Boalsburg, Centre Hall, Port Matilda (Windstream), Spring Mills, State College
Strasburg	Gap (Commonwealth Tel.), Intercourse (Frontier Comm. Of PA), Lancaster, Landisville, Millersville, Quarryville (Commonwealth Tel.), Rawlinsville (Commonwealth Tel.), Strasburg
Stroudsburg	Bushkill, Cresco, Lords Valley, Mount Pocono, Saylorburg (Commonwealth Tel.), Stroudsburg, Stroudsburg, NJ (Verizon – NJ)
Sugar Grove	Russell, Sugar Grove, Warren, Youngsville
Sunbury	Danville, Elysburg, Milton, Northumberland, Selinsgrove (Verizon North), Shamokin, Sunbury
Sykesville	DuBois, Luthersburg (Windstream), Reynoldsville, Sykesville
Tamaqua	Lakewood (Frontier Comm. – Lakewood), Lansford (Windstream), Mahanoy City, McAdoo, New Philadelphia, Pottsville, Tamaqua
Tarentum	New Kensington, Pitb. Subn. Zone 20, Springdale, Tarentum

EXHIBIT 4 - COMPETITIVE LOCAL EXCHANGE

CenturyTel Broadband Services, Inc.

Supplement No. 1
Telephone Pa. P.U.C. Tariff No. 1
Section 5
Original Page 40

Issued: August xx, 2021
Effective: September yy, 2021

Competitive Local Exchange Telecommunications Services

5. Exchange Services

5.1 Exchange Areas

5.1.2 Incumbent Local Exchange Carrier Exchange Areas and Local Calling Areas (LCA)

A. Verizon Pennsylvania Inc. Exchange Areas and Local Calling Areas (Cont'd)

Exchange Area	Exchange, Zone or Wire Center Included in the Local Calling Area
Taylor	Moosic, Olyphant, Pittston, Scranton, Taylor, Wyoming
Tidioute	Endeavor, Tidioute, Tionesta, Warren
Tyrone	Altoona, Bellwood, Tyrone, Warriors Mark (Windstream)
Tionesta	Endeavor, Tidioute, Tionesta
Ulysess	Coudersport, Ulysses
Uniontown	Brownsville, Connellsville, Fairchance, Farmington, Masontown, McClellandtown, New Salem, Point Marion, Republic, Smithfield, Smock, Uniontown
Unionville	Avondale, Coatesville, Kemblesville, Kennett Square, Landenberg, Lenape, Mendenhall, Mortonville, Unionville, West Chester, West Grove, Westtown
Upper Black Eddy	Easton, Ferndale (Commonwealth Tel.), Frenchtown, NJ (Verizon – NJ), Milford, NJ (Verizon – NJ) Riegelsville, Springtown, Uhlerstown (Commonwealth Tel.), Upper Black Eddy
Wallenpaupack	Hamlin, Hawley, Honesdale, Lake Ariel, Lords Valley, Moscow, Newfoundland, Wallenpaupack

EXHIBIT 4 - COMPETITIVE LOCAL EXCHANGE

CenturyTel Broadband Services, Inc.

Supplement No. 1

Telephone Pa. P.U.C. Tariff No. 1

Issued: August xx, 2021

Section 5

Effective: September yy, 2021

Original Page 41

Competitive Local Exchange Telecommunications Services

5. Exchange Services

5.1 Exchange Areas

5.1.2 Incumbent Local Exchange Carrier Exchange Areas and Local Calling Areas (LCA)

A. Verizon Pennsylvania Inc. Exchange Areas and Local Calling Areas (Cont'd)

Exchange Area	Exchange, Zone or Wire Center Included in the Local Calling Area
Wampum	Beaver Falls, Ellwood City, New Castle, Wampum
Warren	Russell, Sheffield (Windstream), Sugar Grove, Tidioute, Warren, Youngsville
Washington	Avella, Buffalo (Verizon North), Canonsburg, Claysville, Hickory (Hickory Tel. Co.), McMurray, Taylorstown (Verizon North), Washington, West Alexander
Washingtonville	Bloomsburg, Danville, Millville, Milton, Turbotville (Windstream), Washingtonville
Weatherly	Freeland, Hazleton, Jim Thorpe, McAdoo, Weatherly, White Haven
West Alexander	Claysville, Washington, West Alexander
West Chester	Downingtown, Exton, Lenape, Mendenhall, Mortonville, Phila. Subn. Zone 28, West Chester, Westtown
West Grove	Avondale, Coatesville, Kemblesville, Kennett Square, Landenberg, Lenape, Mendenhall, Mortonville, Oxford, Parkesburg, Unionville, West Chester, West Grove, Westtown, Hockessin, DE (Verizon – DE)

EXHIBIT 4 - COMPETITIVE LOCAL EXCHANGE

CenturyTel Broadband Services, Inc.

Supplement No. 1
Telephone Pa. P.U.C. Tariff No. 1
Section 5
Original Page 42

Issued: August xx, 2021
Effective: September yy, 2021

Competitive Local Exchange Telecommunications Services

5. Exchange Services

5.1 Exchange Areas

5.1.2 Incumbent Local Exchange Carrier Exchange Areas and Local Calling Areas (LCA)

A. Verizon Pennsylvania Inc. Exchange Areas and Local Calling Areas (Cont'd)

Exchange Area	Exchange, Zone or Wire Center Included in the Local Calling Area
West Middlesex	Sharon, Sharon, O. (AMERITECH, O.), Sharpsville, West Middlesex
West Newton	Belle Vernon, West Newton, Yukon (Yukon-Waltz Tel. Co.)
Westtown	Lenape, Mendenhall, Phila. Subn. Zone 10, West Chester, Westtown
White Haven	Freeland, Hazleton, Jim Thorpe, Weatherly, White Haven
Wilkes-Barre	Center Moreland (Commonwealth Tel.), Dallas (Commonwealth Tel.), Harveys Lake (Commonwealth Tel.), Kingston, Mountaintop, Nanticoke, Nuangola (Commonwealth Tel.), Pittston, Plymouth, Trucksville (Commonwealth Tel.), Wilkes-Barre, Wyoming
Williamsport	Jersey Shore, Loyalsock (Verizon North), Oval (Pennsylvania Tel. Co.), Trout Run (Verizon North), Williamsport

EXHIBIT 4 - COMPETITIVE LOCAL EXCHANGE

CenturyTel Broadband Services, Inc.

Supplement No. 1

Telephone Pa. P.U.C. Tariff No. 1

Issued: August xx, 2021

Section 5

Effective: September yy, 2021

Original Page 43

Competitive Local Exchange Telecommunications Services

5. Exchange Services

5.1 Exchange Areas

5.1.2 Incumbent Local Exchange Carrier Exchange Areas and Local Calling Areas (LCA)

A. Verizon Pennsylvania Inc. Exchange Areas and Local Calling Areas (Cont'd)

Exchange Area	Exchange, Zone or Wire Center Included in the Local Calling Area
Winburne	Clearfield, Frenchville, Philipsburg, Winburne
Woolrich	Avis, Jersey Shore, Lock Haven, Woolrich
Wycombe	Buckingham, Doylestown, New Hope, Newtown, Phila. Subn. Zone 40, Phila. Subn. Zone 45, Wycombe
Wyoming	Kingston, Moosic, Pittston, Scranton, Taylor, Wilkes- Barre, Wyoming
Yardley	Ewing, NJ (Verizon - NJ), Morrisville, New Hope, Newtown, Phila. Subn. Zone 42, Phila. Subn. Zone 43, Phila. Subn. Zone 44, Trenton, NJ (Verizon - NJ), Wycombe, Yardley
Youngsville	Russell, Sugar Grove, Warren, Youngsville
Youngwood	Greensburg, Mount Pleasant, Youngwood
Zelienople	Beaver Falls, Criders Corners (North Pitt. Tel. Co.), Ellwood City, Evans City (CenturyLink), Zelienople

EXHIBIT 4 - COMPETITIVE LOCAL EXCHANGE

CenturyTel Broadband Services, Inc.

Supplement No. 1
Telephone Pa. P.U.C. Tariff No. 1
Section 5
Original Page 44

Issued: August xx, 2021
Effective: September yy, 2021

Competitive Local Exchange Telecommunications Services

5. Exchange Services

5.1 Exchange Areas

5.1.2 Incumbent Local Exchange Carrier Exchange Areas and Local Calling Areas (LCA) (Cont'd)

B. Verizon North Incorporated Exchange Areas and Local Calling Areas

Exchange Area	Exchange, Zone or Wire Center Included in the Local Calling Area
Airville	Brogue, Delta, Red Lion
Auburn	Friedensburg, Orwigsburg, Pine Grove, Pottsville, Schuylkill Haven
Avonmore	Apollo (Windstream), Saltsburg, Vandergrift
Beach Lake	Galilee, Honesdale, Narrowsburg, NY (Citizens Tel.)
Beaver Springs	Middleburg, Mount Pleasant Mills, Selinsgrove
Beaverdale	Johnstown, South Fork
Berlin	Meyersdale, Rockwood, Somerset, Stoystown
Bernville	Frystown, Hamburg, Robesonia, Womelsdorf, Reading
Boswell	Hooversville, Johnstown, Somerset, Stoystown
Brogue	Airville, Red Lion, York
Brookside	Jersey Shore, Trout Run, Williamsport

EXHIBIT 4 - COMPETITIVE LOCAL EXCHANGE

CenturyTel Broadband Services, Inc.

Supplement No. 1
Telephone Pa. P.U.C. Tariff No. 1
Section 5
Original Page 45

Issued: August xx, 2021
Effective: September yy, 2021

Competitive Local Exchange Telecommunications Services

5. Exchange Services

5.1 Exchange Areas

5.1.2 Incumbent Local Exchange Carrier Exchange Areas and Local Calling Areas (LCA)

B. Verizon North Incorporated Exchange Areas and Local Calling Areas (Cont'd)

Exchange Area	Exchange, Zone or Wire Center Included in the Local Calling Area
Buffalo	Avella, Canonsburg, Taylorstown, Washington
Cambridge Springs	Edinboro, Meadville, Saegertown (Windstream)
Central City	Berlin, Johnstown, Somerset, Windber
Chapman Lake	Carbondale, Clark Summit (Commonwealth Telephone Co.), Jermyn, Olyphant, Scranton
Clintonville	Franklin, Wesley
Confluence	Rockwood, Salisbury
Cooperstown	Franklin, Oil City
Corry	Spartansburg, Union City, Wattsburg
Davidsville	Johnstown
Delta	Airville, Fawn Grove, Cardiff, Md. (Verizon – Md.)
Dillsburg	Dover, Harrisburg Zone 1, Mechanicsburg

EXHIBIT 4 - COMPETITIVE LOCAL EXCHANGE

CenturyTel Broadband Services, Inc.

Supplement No. 1

Telephone Pa. P.U.C. Tariff No. 1

Issued: August xx, 2021

Section 5

Effective: September yy, 2021

Original Page 46

Competitive Local Exchange Telecommunications Services

5. Exchange Services

5.1 Exchange Areas

5.1.2 Incumbent Local Exchange Carrier Exchange Areas and Local Calling Areas (LCA)

B. Verizon North Incorporated Exchange Areas and Local Calling Areas (Cont'd)

Exchange Area	Exchange, Zone or Wire Center Included in the Local Calling Area
Dingman's Ferry	Milford/Log Tavern, Montague, NJ (CenturyLink)
East Berlin	Dover, Hanover (CenturyLink), New Oxford (CenturyLink), York
Edinboro	Cambridge Springs, Erie, McKean
Elkland	Knoxville, Lawrenceville (Commonwealth Telephone Co.), Westfield
Emmaus	Allentown, Bethlehem, Ironton (Ironton Telephone Co.)
Erie	Edinboro, Fairview, Girard, McKean, North East, Waterford, Wattsburg
Fairview	Erie, Girard, McKean
Fawn Grove	Delta, Stewartstown, Jarrettsville, Md. (Service to NXX 692 and 941 only), Cardiff, Md. (Verizon – Md.)
Franklin	Cooperstown, Oil City
Friedensburg	Auburn, Orwigsburg, Pine Grove, Pottsville, Schuylkill Haven

EXHIBIT 4 - COMPETITIVE LOCAL EXCHANGE

CenturyTel Broadband Services, Inc.

Supplement No. 1
Telephone Pa. P.U.C. Tariff No. 1
Section 5
Original Page 47

Issued: August xx, 2021
Effective: September yy, 2021

Competitive Local Exchange Telecommunications Services

5. Exchange Services

5.1 Exchange Areas

5.1.2 Incumbent Local Exchange Carrier Exchange Areas and Local Calling Areas (LCA)

B. Verizon North Incorporated Exchange Areas and Local Calling Areas (Cont'd)

Exchange Area	Exchange, Zone or Wire Center Included in the Local Calling Area
Frystown	Bernville, Jonestown, Myerstown, Lebanon
Galilee	Beach Lake, Callicoon (Verizon – NY), Honesdale, Narrowsburg, NY (Citizens Tel.)
Girard	Erie, Fairview
Glen Rock	Jefferson, Loganville, Stewartstown, York
Grand Valley	Pleasantville, Titusville, Youngsville
Harrison Valley	Ulysses, Westfield
Hershey	Annville, Elizabethtown (CenturyLink), Harrisburg Zone 1 and 2, Hummelstown, Lebanon, Middletown, Palmyra, Shellsville, Steelton
Hooversville	Boswell, Johnstown, Stoystown, Somerset
Jefferson	Glen Rock, Hanover (CenturyLink), Spring Grove, York
Johnstown	Beaverdale, Davidsville, Nanty Glo, Seward, South Fork, Windber
Jonestown	Frystown, Shellsville, Annville, Lebanon

EXHIBIT 4 - COMPETITIVE LOCAL EXCHANGE

CenturyTel Broadband Services, Inc.

Supplement No. 1
Telephone Pa. P.U.C. Tariff No. 1
Section 5
Original Page 48

Issued: August xx, 2021
Effective: September yy, 2021

Competitive Local Exchange Telecommunications Services

5. Exchange Services

5.1 Exchange Areas

5.1.2 Incumbent Local Exchange Carrier Exchange Areas and Local Calling Areas (LCA)

B. Verizon North Incorporated Exchange Areas and Local Calling Areas (Cont'd)

Exchange Area	Exchange, Zone or Wire Center Included in the Local Calling Area
Kempton	Allentown, Hamburg, Kutztown, New Smithville, New Tripoli
Knoxville	Elkland
Lincolnton	Union City, Spartansburg, Townville (Windstream)
Loganville	Glen Rock, Red Lion, York
Loyalsock	Muncy, Trout Run, Williamsport
Manchester	Dover, York
Mantzville	Lehighton, McKeansburg, Tamaqua
Matamoras	Cuddebackville, NY (Verizon – NY), Milford/Log Tavern, Montague, NJ (CenturyLink), Port Jervis, NY (Verizon – NY)
McKean	Edinboro, Erie, Fairview
McKeansburg	Mantzville, Orwigsburg, Pottsville, Schuylkill Haven
Meyersdale	Berlin, Rockwood, Salisbury, Somerset

EXHIBIT 4 - COMPETITIVE LOCAL EXCHANGE

CenturyTel Broadband Services, Inc.

Issued: August xx, 2021
Effective: September yy, 2021

Supp. No. ~ to
Supplement No. 1
Telephone Pa. P.U.C. Tariff No. 1
Section 5
Original Page 49

Competitive Local Exchange Telecommunications Services

5. Exchange Services

5.1 Exchange Areas

5.1.2 Incumbent Local Exchange Carrier Exchange Areas and Local Calling Areas (LCA)

B. Verizon North Incorporated Exchange Areas and Local Calling Areas (Cont'd)

Exchange Area	Exchange, Zone or Wire Center Included in the Local Calling Area
Middleburg	Beaver Springs, Mifflinburg (Buffalo Valley Tel. Co.), Mount Pleasant Mills, Selinsgrove
Milford/Log Tavern	Cuddlebackville, NY (Verizon – NY), Dingman's Ferry, Matamoras, Montague, NJ (CenturyLink), Port Jervis, NY (Verizon – NY)
Mount Pleasant Mills	Beaver Springs, Middleburg, Selinsgrove
Myerstown	Frystown, Schaefferstown, Womelsdorf, Lebanon
Nanty Glo	Ebensburg, Johnstown
New Bedford	New Castle, New Wilmington
New Smithville	Allentown, Ironton (Ironton Telephone Co.), Kempton, New Tripoli
New Tripoli	Allentown, Kempton, New Smithville, Slatington
New Wilmington	New Bedford, New Castle, Sharon, Volant (CenturyLink)
North East	Erie, South Ripley, NY (Verizon – NY), Wattsburg

EXHIBIT 4 - COMPETITIVE LOCAL EXCHANGE

CenturyTel Broadband Services, Inc.

Supplement No. 1

Telephone Pa. P.U.C. Tariff No. 1

Issued: August xx, 2021

Section 5

Effective: September yy, 2021

Original Page 50

Competitive Local Exchange Telecommunications Services

5. Exchange Services

5.1 Exchange Areas

5.1.2 Incumbent Local Exchange Carrier Exchange Areas and Local Calling Areas (LCA)

B. Verizon North Incorporated Exchange Areas and Local Calling Areas (Cont'd)

Exchange Area	Exchange, Zone or Wire Center Included in the Local Calling Area
Oil City	Cooperstown, Franklin, Pleasantville, Titusville
Pine Grove	Auburn, Friedensburg, Tremont (Commonwealth Telephone Co.)
Pleasantville	Grand Valley, Oil City, Titusville
Princeton	New Castle, Portersville (CenturyLink), Ellwood City
Red Lion	Brogue, Loganville, York
Robesonia	Bernville, Womelsdorf, Reading
Rockwood	Berlin, Confluence, Meyersdale, Somerset
Sabinsville	Westfield
Salisbury	Confluence, Meyersdale, Grantsville, Md. (Verizon – Md.)
Saltsburg	Avonmore
Sayre	Waverly, NY (Verizon – NY)

EXHIBIT 4 - COMPETITIVE LOCAL EXCHANGE

CenturyTel Broadband Services, Inc.

Supplement No. 1
Telephone Pa. P.U.C. Tariff No. 1
Section 5
Original Page 51

Issued: August xx, 2021
Effective: September yy, 2021

Competitive Local Exchange Telecommunications Services

5. Exchange Services

5.1 Exchange Areas

5.1.2 Incumbent Local Exchange Carrier Exchange Areas and Local Calling Areas (LCA)

B. Verizon North Incorporated Exchange Areas and Local Calling Areas (Cont'd)

Exchange Area	Exchange, Zone or Wire Center Included in the Local Calling Area
Schaefferstown	Myerstown, Womelsdorf, Lebanon
Selinsgrove	Beaver Springs, Middleburg, Mount Pleasant Mills, Sunbury
Selinsgrove – Shamokin Dam	Beaver Springs, Middleburg, Mount Pleasant Mills, Sunbury
Seward	Johnstown, New Florence
Shellsville	Jonestown, Harrisburg Zone 1, Hummelstown, Hershey
Shohola	Barryville, NY (Verizon – NY), Milford/Log Tavern
Somerset	Berlin, Boswell, Rockwood, Stoystown
South Fork	Beaverdale, Johnstown
Spartansburg	Corry, Lincolnville, Titusville, Townville (Windstream)

EXHIBIT 4 - COMPETITIVE LOCAL EXCHANGE

CenturyTel Broadband Services, Inc.

Issued: August xx, 2021
Effective: September yy, 2021

Supp. No. ~ to
Supplement No. 1
Telephone Pa. P.U.C. Tariff No. 1
Section 5
Original Page 52

Competitive Local Exchange Telecommunications Services

5. Exchange Services

5.1 Exchange Areas

5.1.2 Incumbent Local Exchange Carrier Exchange Areas and Local Calling Areas (LCA)

B. Verizon North Incorporated Exchange Areas and Local Calling Areas (Cont'd)

Exchange Area	Exchange, Zone or Wire Center Included in the Local Calling Area
Spring Grove	Hanover (CenturyLink), Jefferson, York
Stewartstown	Fawn Grove, Glen Rock, Red Lion, York, Jarrettsville, Md. (Service to NXX 941 only)
Stoystown	Berlin, Boswell, Hooversville, Somerset
Taylorstown	Buffalo, Claysville, Washington
Titusville	Grand Valley, Oil City, Pleasantville, Spartansburg
Trout Run	Brookside, Loyalsock, Williamsport
Union City	Corry, Erie, Lincolnville, Waterford, Wattsburg
Vandergrift	Apollo (Windstream), Avonmore, Leechburg (Windstream)
Waterford	Erie, Union City, Wattsburg
Wattsburg	Corry, Erie, North East, Uion City, Waterford

EXHIBIT 4 - COMPETITIVE LOCAL EXCHANGE

CenturyTel Broadband Services, Inc.

Supplement No. 1
Telephone Pa. P.U.C. Tariff No. 1
Section 5
Original Page 53

Issued: August xx, 2021
Effective: September yy, 2021

Competitive Local Exchange Telecommunications Services

5. Exchange Services

5.1 Exchange Areas

5.1.2 Incumbent Local Exchange Carrier Exchange Areas and Local Calling Areas (LCA)

B. Verizon North Incorporated Exchange Areas and Local Calling Areas (Cont'd)

Exchange Area	Exchange, Zone or Wire Center Included in the Local Calling Area
Wellersburg	Mt. Savage, Md., Cumberland, Md., Frostburg, Md. (Verizon – Md.), Meyersdale, Hyndman (CenturyLink)
Wesley	Clintonville, Harrisville (CenturyLink), Grove City, Mercer
Westfield	Elkland, Harrison Valley, Knoxville, Sabinsville
Windber	Central City, Johnstown
Womelsdorf	Bernville, Myerstown, Robesonia, Schaefferstown, Reading
Wrightsville	Red Lion, York, Columbia (CenturyLink)
York	Dover, Loganville, Manchester, Red Lion, Spring Grove, Wrightsville

EXHIBIT 4 - COMPETITIVE LOCAL EXCHANGE

CenturyTel Broadband Services, Inc.

Supplement No. 1
Telephone Pa. P.U.C. Tariff No. 1
Section 5
Original Page 54

Issued: August xx, 2021
Effective: September yy, 2021

Competitive Local Exchange Telecommunications Services

5. Exchange Services

5.1 Exchange Areas

5.1.2 Incumbent Local Exchange Carrier Exchange Areas and Local Calling Areas (LCA)

C. Frontier Commonwealth Exchange Areas and Local Calling Areas (Cont'd)

An "*" next to exchange in Local Service Area indicates a one-way EAS route; all others are two-way.

Exchange Area	Exchange, Zone or Wire Center Included in the Local Calling Area
Atglen	Atglen, Gap, Parkesburg
Bangor	Bangor, Belvidere, Easton*, Pen Argyl, Portland, Saylorburg
Belvidere	Bangor, Belvidere, Belvidere, NJ, Easton*, Hope, NJ, Oxford, NJ, Pen Argyl
Benton	Benton, Huntington Mills, Orangeville
Blossburg	Blossburg, Covington, Liberty, Mansfield, Wellsboro*
Brooklyn	Brooklyn, Montrose, Nicholson, Springville
Center Moreland	Center Moreland, Dallas, Harding, Harveys Lake, Kingston, Lake Winola, Noxen, Pittston*, Trucksville, Tunkhannock, Wilkes-Barre, Wyoming*
Clarks Summit	Clarks Summit, Dalton, Factoryville, Lake Winola, Scranton
Conyngam-Drums	Conyngam, Hazleton, Nuremberg, Wapwallopen
Coopersburg	Allentown, Bethlehem, Coopersburg, Emmaus* , Quakertown*
Covington	Blossburg, Covington, Liberty, Mansfield, Wellsboro*
Dallas	Center Moreland, Dallas, Harding, Harveys Lake, Kingston, Noxen, Sweet Valley, Trucksville, Wilkes-Barre
Dalton	Clarks Summit, Dalton, Factoryville, Lake Winola, Nicholson, Scranton

EXHIBIT 4 - COMPETITIVE LOCAL EXCHANGE

CenturyTel Broadband Services, Inc.

Supplement No. 1
Telephone Pa. P.U.C. Tariff No. 1
Section 5
Original Page 55

Issued: August xx, 2021
Effective: September yy, 2021

Competitive Local Exchange Telecommunications Services

5. Exchange Services

5.1 Exchange Areas

5.1.2 Incumbent Local Exchange Carrier Exchange Areas and Local Calling Areas (LCA)

C. Frontier Commonwealth Exchange Areas and Local Calling Areas (Cont'd)

Exchange Area	Exchange, Zone or Wire Center Included in the Local Calling Area
Dushore	Dushore, Estella, Laporte, New Albany
Eagles Mere	Eagles Mere, Estella, Laporte, Muncy Valley
Estella	Dushore, Eagles Mere, Estella, Laporte
Elizabethville	Elizabethville, Gratz, Halifax, Lykens, Millersburg
Factoryville	Clarks Summit, Clifford, Dalton, Factoryville, Lake Winola, Nicholson, Scranton, Tunkhannock
Ferndale	Bedminster, Doylestown*, Ferndale, Milford, NJ, Plumsteadville, Quakertown, Reigelsville, Springtown, Uhlertown, Upper Black Eddy
Gap	Atglen, Gap, Intercourse, Kirkwood, Parkesburg, Quarryville, AStrasburg, Lancaster*
Gratz	Elizabethville, Gratz, Lykens, Tower City, Valley View
Hallstead	Hallstead, Lawsville, New Milford, Susquehanna
Harding	Center Moreland, Clarks Summit*, Dallas, Harding, Pittston, Scranton*, Trucksville, Tunkhannock*, Wilkes- Barre*
Harveys Lake	Center Moreland, Dallas, Harveys Lake, Kingston Noxen, Sweet Valley, Trucksville, Wilkes-Barre*
Hensel	Hensel, Kirkwood, Lancaster*, Quarryville, Rawlinsville
Huntington Mills	Benton, Huntington Mills, Muhlenburg, Shickshinny

EXHIBIT 4 - COMPETITIVE LOCAL EXCHANGE

CenturyTel Broadband Services, Inc.

Supplement No. 1
Telephone Pa. P.U.C. Tariff No. 1
Section 5
Original Page 56

Issued: August xx, 2021
Effective: September yy, 2021

Competitive Local Exchange Telecommunications Services

5. Exchange Services

5.1 Exchange Areas

5.1.2 Incumbent Local Exchange Carrier Exchange Areas and Local Calling Areas (LCA)

C. Frontier Commonwealth Exchange Areas and Local Calling Areas (Cont'd)

Exchange Area	Exchange, Zone or Wire Center Included in the Local Calling Area
Kirkwood	Gap, Hensel, Kirkwood, Lancaster* , Oxford, Quarryville
Laceyville	Laceyville, Mehoopany, Tunckhannock* , Wyalusing
Lake Winola	Center Moreland, Clarks Summit, Dalton, Factoryville, Winola, Nicholson, Scranton, Tunhannock
Laporte	Dushore, Eagles Mere, Estella, Laporte, Muncy Valley, New Albany
Lawrenceville	Elkland, Lawrenceville, Tioga
Lawsville	Hallstead, Lawsville, Montrose, Rush, St. Joseph
Leesport	Fleetwood, Hamburg, Leesport, Reading
Leraysville	LeRaysville, Rome, Rush, Towanda, Warren Center
Lewisberry	Harrisburg (Zone1) Lewisberry, Mechanicsburg
Liberty	Blossburg, Liberty, Morris
Lykens	Elizabethville, Gratz, Lykens, Tower City, Valley View
Mansfield	Blossburg, Covington, Mansfield, Roseville, Tioga, Wellsboro
Mehoopany	Laceyville, Mehoopany, Tunkhannock
Middlebury Center	Middlebury Center, Tioga, Wellsboro

EXHIBIT 4 - COMPETITIVE LOCAL EXCHANGE

CenturyTel Broadband Services, Inc.

Supplement No. 1
Telephone Pa. P.U.C. Tariff No. 1
Section 5
Original Page 57

Issued: August xx, 2021
Effective: September yy, 2021

Competitive Local Exchange Telecommunications Services

5. Exchange Services

5.1 Exchange Areas

5.1.2 Incumbent Local Exchange Carrier Exchange Areas and Local Calling Areas (LCA)

C. Frontier Commonwealth Exchange Areas and Local Calling Areas (Cont'd)

Exchange Area	Exchange, Zone or Wire Center Included in the Local Calling Area
Millersburg	Elizabethville, Halifax, Millersburg
Montrose	Brooklyn, Lawsville, Montrose, Rush, St. Joseph, Springville
Morris	Liberty, Morris, Wellsboro
Muhlenburg	Huntingdon Mills, Muhlenburg, Nanticoke*, Shickshinny, Sweet Valley, Wilkes-Barre*
Muncy Valley	Eagles Mere, Hughesville*, Laporte, Muncy Valley
New Albany	Dushore, Laporte, New Albany, Towanda, Wyalusing
Nicholson	Brooklyn, Dalton, Factoryville, Lake Winola, Nicholson, Springville, Tunkhannock*
Noxen	Centermoreland, Dallas, Harveys Lake, Noxen, Sweet Valley, Trucksville, Tunkhannock
Nuangola	Mountaintop, Nanticoke, Nuangola, Shickshinny, Wapwallopen, Wilkes-Barre
Nuremberg	Conyngham, Hazleton, Nuremberg, Ringtown

EXHIBIT 4 - COMPETITIVE LOCAL EXCHANGE

CenturyTel Broadband Services, Inc.

Supplement No. 1
Telephone Pa. P.U.C. Tariff No. 1
Section 5
Original Page 58

Issued: August xx, 2021
Effective: September yy, 2021

Competitive Local Exchange Telecommunications Services

5. Exchange Services

5.1 Exchange Areas

5.1.2 Incumbent Local Exchange Carrier Exchange Areas and Local Calling Areas (LCA)

C. Frontier Commonwealth Exchange Areas and Local Calling Areas (Cont'd)

Exchange Area	Exchange, Zone or Wire Center Included in the Local Calling Area
Orangeville	Benton, Berwick*, Bloomsburg, Orangeville
Pen Argyl	Bangor, Belvidere, Easton*, Nazareth*, Pen Argyl, Saylorsburg
Pocono Lake	Mount Pocono*, Pocono Lake, Stroudsburg*, White Haven*
Portland	Bangor, Columbia, NJ, Portland, Stroudsburg*
Quarryville	Gap, Hensel, Kirkwood, Lancaster , Quarryville, Rawlinsville, Strasburg
Rawlinsville	Hensel, Lancaster, Millersville*, Quarryville, Rawlinsville, Strasburg
Ringtown	Nuremberg, Ringtown, Shenandoah
Rome	LeRaysville, Nichols, NY , Rome, Sayre* , Towanda, Ulster, Warren Center
Rush	Lawsville, LeRaysville, Montrose, Rush, Springville, St. Joseph
St. Joseph	Lawsville, Montrose, Rush, St. Joseph, Warren Center

EXHIBIT 4 - COMPETITIVE LOCAL EXCHANGE

CenturyTel Broadband Services, Inc.

Supplement No. 1
Telephone Pa. P.U.C. Tariff No. 1
Section 5
Original Page 59

Issued: August xx, 2021
Effective: September yy, 2021

Competitive Local Exchange Telecommunications Services

5. Exchange Services

5.1 Exchange Areas

5.1.2 Incumbent Local Exchange Carrier Exchange Areas and Local Calling Areas (LCA)

C. Frontier Commonwealth Exchange Areas and Local Calling Areas (Cont'd)

Exchange Area	Exchange, Zone or Wire Center Included in the Local Calling Area
Saylorsburg	Bangor, Pen Argyl, Saylorsburg, Stroudsburg
Shickshinny	Berwick, Huntington Mills, Muhlenburg, Nanticoke*, Nuangola, Shickshinny, Wapwallopen, Wilkes-Barre*
Springville	Brooklyn, Montrose, Nicholson, Rush, Springville, Tunkhannock*
Susquehanna	Hallstead, Jackson, Susquehanna, Thompson
Sweet Valley	Dallas, Harveys Lake, Kingston*, Muhlenburg, Noxen, Sweet Valley, Trucksville, Wilkes-Barre
Tioga	Lawrenceville, Mansfield, Middlebury Center, Tioga, Wellsboro*
Towanda	LeRaysville, Leroy, New Albany, Rome, Towanda, Troy, Ulster, Wyalusing
Tower City	Gratz, Lykens, Tower City, Tremont, Valley View
Tremont	Minersville, Pine Grove, Pottsville*, Tower City, Tremont, Valley View

EXHIBIT 4 - COMPETITIVE LOCAL EXCHANGE

CenturyTel Broadband Services, Inc.

Supplement No. 1
Telephone Pa. P.U.C. Tariff No. 1
Section 5
Original Page 60

Issued: August xx, 2021
Effective: September yy, 2021

Competitive Local Exchange Telecommunications Services

5. Exchange Services

5.1 Exchange Areas

5.1.2 Incumbent Local Exchange Carrier Exchange Areas and Local Calling Areas (LCA)

C. Frontier Commonwealth Exchange Areas and Local Calling Areas (Cont'd)

Exchange Area	Exchange, Zone or Wire Center Included in the Local Calling Area
Troy	Canton, Leroy, Towanda, Troy
Trucksville	Center Moreland, Dallas, Harding, Harveys Lake, Kingston, Noxen, Sweet Valley, Trucksville, Wilkes- Barre
Tunkhannock	Centermoreland, Factoryville, Lake Winola, Mehoopany, Noxen, Tunkhannock
Uhlerstown	Doylestown* , Ferndale, Frenchtown, NJ, Plumsteadville*, Uhlerstown, Upper Black Eddy
Ulster	Rome, Sayre* , Towanda, Ulster
Valley View	Gratz, Lykens, Tower City, Tremont, Valley View
Wapwallopen	Berwick, Conyngham, Nuangola, Shickshinny, Wapwallopen
Warren Center	LeRaysville, Nichols, NY, Rome, St. Joseph, Warren Center
Wellsboro	Mansfield, Middlebury Center, Morris, Wellsboro
Wyalusing	Laceyville, New Albany, Towanda, Wyalusing

EXHIBIT 4 - COMPETITIVE LOCAL EXCHANGE

CenturyTel Broadband Services, Inc.

Supplement No. 1
Telephone Pa. P.U.C. Tariff No. 1
Section 5
Original Page 61

Issued: August xx, 2021
Effective: September yy, 2021

Competitive Local Exchange Telecommunications Services

5. Exchange Services

5.1 Exchange Areas

5.1.2 Incumbent Local Exchange Carrier Exchange Areas and Local Calling Areas (LCA) (Cont'd)

D. Consolidated Communications of PA Exchange Areas and Local Calling Areas

Exchange Area	Exchange, Zone or Wire Center Included in the Local Calling Area
Cooperstown	Cooperstown, Criders Corners, Curtisville, Freeport, Gibsonia, Mars, Saxonburg, Wexford, Butler and Nixon
Criders Corners	Cooperstown, Criders Corners, Curtisville, Freeport, Gibsonia, Mars, Saxonburg, Wexford, Perrysville and Zelianople
Curtisville	Cooperstown, Criders Corners, Curtisville, Freeport, Gibsonia, Mars, Saxonburg, Wexford and Tarentum
Freeport	Cooperstown, Criders Corners, Curtisville, Freeport, Gibsonia, Mars, Saxonburg, Wexford and Tarentum
Gibsonia	Cooperstown, Criders Corners, Curtisville, Freeport, Gibsonia, Mars, Saxonburg, Wexford and Glenshaw
Mars	Cooperstown, Criders Corners, Curtisville, Freeport, Gibsonia, Mars, Saxonburg, Wexford and Perrysville
Saxonburg	Butler , Cooperstown, Criders Corners, Curtisville, Freeport, Gibsonia, Mars, Saxonburg, Wexford and Tarentum
Wexford	Cooperstown, Criders Corners, Curtisville, Freeport, Gibsonia, Mars, Saxonburg, Perrysville, and Wexford

EXHIBIT 4 - COMPETITIVE LOCAL EXCHANGE

CenturyTel Broadband Services, Inc.

Supplement No. 1
Telephone Pa. P.U.C. Tariff No. 1
Section 5
Original Page 62

Issued: August xx, 2021
Effective: September yy, 2021

Competitive Local Exchange Telecommunications Services

5. Exchange Services

5.1 Exchange Areas

5.1.2 Incumbent Local Exchange Carrier Exchange Areas and Local Calling Areas (LCA) (Cont'd)

E. Ironton Telephone Company Exchange Areas and Local Calling Areas

Exchange Area	Exchange, Zone or Wire Center Included in the Local Calling Area
Ironton	Allentown, Bath, Bethlehem, Catasauqua, Coopersburg, Easton, Emmaus, Hellertown, Kempton, Kutztown, Nazareth, New Smithville, New Tripoli, Northampton, Slatington, Springtown, Topton, Upper Black Eddy

F. Marianna and Scenery Hill Telephone Company Exchange Areas and Local Calling Areas

Exchange Area	Exchange, Zone or Wire Center Included in the Local Calling Area
Marianna	Bentleyville, Fredericktown, Marianna, Richeyville, Scenery Hill, Washington
Scenery Hill	Bentleyville, Fredericktown, Marianna, Richeyville, Scenery Hill, Washington

EXHIBIT 4 - COMPETITIVE LOCAL EXCHANGE

CenturyTel Broadband Services, Inc.

Supplement No. 1
Telephone Pa. P.U.C. Tariff No. 1
Section 5
Original Page 63

Issued: August xx, 2021
Effective: September yy, 2021

Competitive Local Exchange Telecommunications Services

5. Exchange Services

5.1 Exchange Areas

5.1.2 Incumbent Local Exchange Carrier Exchange Areas and Local Calling Areas (LCA) (Cont'd)

G. North Eastern PA Telephone Company Exchange Areas and Local Calling Areas

Exchange Area	Exchange, Zone or Wire Center Included in the Local Calling Area
Clifford	Carbondale, Clifford, Factoryville
Forest City	Carbondale, Forest City, Pleasant Mount, Union Dale
Harford	Clifford, Harford, New Milford
Jackson	Jackson, New Milford, Susquehanna, Thompson
New Milford	Hallstead, Harford, New Milford
Pleasant Mount	Forest City, Honesdale, Pleasant Mount, Union Dale
Thompson	Jackson, Susquehanna, Thompson
Union Dale	Forest City, Pleasant Mount, Union Dale

EXHIBIT 4 - COMPETITIVE LOCAL EXCHANGE

CenturyTel Broadband Services, Inc.

Supplement No. 1

Telephone Pa. P.U.C. Tariff No. 1

Issued: August xx, 2021

Section 5

Effective: September yy, 2021

Original Page 64

Competitive Local Exchange Telecommunications Services

5. Exchange Services

5.1 Exchange Areas

5.1.2 Incumbent Local Exchange Carrier Exchange Areas and Local Calling Areas (LCA) (Cont'd)

H. United Telephone Co. of PA Exchange Areas and Local Calling Area

Exchange Area	Exchange, Zone or Wire Center Included in the Local Calling Area
Allensville	Allensville, Belleville, Huntingdon, Lewistown
Bedford	Bedford, Charlesville, Everett, Fishertown, Osterburg, Schellsburg
Bedford Valley	Bedford, Bedford Valley, Hyndman
Beech Creek	Beech Creek, Howard, Lock Haven, Mill Hall
Belleville	Allensville, Belleville, Lewistown, Reedsville
Biglerville	Biglerville, Gettysburg, York Springs
Blacktown	Blacktown, Plain Grove, Volant, Grove City, Mercer
Blain	Blain, East Waterford, Loysville
Blue Ridge Summit	Blue Ridge Summit, Highfield, Md., Waynesboro
Bruin	Chicora, North Washington, Parker, Petrolia, Bruin
Butler	Chicora, Connoquenessing, Meridian, Nixon, Prospect, West Sunbury, Butler
Carlisle	Carlisle, Mount Holly Springs, Newville
Chambersburg	Chambersburg, Fayetteville, Marion, Saint Thomas
Charlesville	Bedford, Charlesville, Everett

EXHIBIT 4 - COMPETITIVE LOCAL EXCHANGE

CenturyTel Broadband Services, Inc.

Supplement No. 1

Telephone Pa. P.U.C. Tariff No. 1

Issued: August xx, 2021

Section 5

Effective: September yy, 2021

Original Page 65

Competitive Local Exchange Telecommunications Services

5. Exchange Services

5.1 Exchange Areas

5.1.2 Incumbent Local Exchange Carrier Exchange Areas and Local Calling Areas (LCA)

H. United Telephone Co. of PA Exchange Areas and Local Calling Areas (Cont'd)

Exchange Area	Exchange, Zone or Wire Center Included in the Local Calling Area
Chicora	Bruin, Butler, North Washington, Petrolia, Chicora
Claysburg	Altoona , Claysburg, Hollidaysburg, Osterburg, Roaring Spring
Clearville	Bedford, Clearville, Everett
Columbia	Columbia, Elizabethtown, Lancaster, Marietta, Mount Joy, Mountville, Wrightsville
Connoquenessing	Butler, Evans City, Meridian, Nixon, Prospect, Connoquenessing
Dry Run	Chambersburg, Dry Run
Duncannon	Duncannon, Harrisburg Zone 1, Marysville, New Bloomfield, Newport
East Waterford	Blain, East Waterford, Mifflintown, Port Royal
Eau Claire	Emlenton, Foxburg, North Washington, Parker, Eau Claire
Elizabethtown	Elizabethtown, Columbia, Hershey, Lancaster, Marietta, Mt. Joy, Middletown
Emlenton	Eau Claire, Foxburg, Parker, Rockland, Emlenton
Evans City	Butler, Connoquenessing, Criders Corners, Nixon, Zelienople, Evans City
Everett	Bedford, Breezewood, Clearville, Everett

EXHIBIT 4 - COMPETITIVE LOCAL EXCHANGE

CenturyTel Broadband Services, Inc.

Supplement No. 1

Telephone Pa. P.U.C. Tariff No. 1

Issued: August xx, 2021

Section 5

Effective: September yy, 2021

Original Page 66

Competitive Local Exchange Telecommunications Services

5. Exchange Services

5.1 Exchange Areas

5.1.2 Incumbent Local Exchange Carrier Exchange Areas and Local Calling Areas (LCA)

H. United Telephone Co. of PA Exchange Areas and Local Calling Areas (Cont'd)

Exchange Area	Exchange, Zone or Wire Center Included in the Local Calling Area
Fairfield	Emmitsburg, Md., Fairfield, Gettysburg
Fayetteville	Chambersburg, Fayetteville
Fishertown	Bedford, Fishertown, Osterburg, Schellsburg
Foxburg	Eau Claire, Emlenton, Parker, Foxburg
Gettysburg	Biglerville, Fairfield, Gettysburg
Greencastle	Chambersburg, Greencastle, Marion, Waynesboro
Hanover	Hanover, Jefferson, Littlestown, New Oxford
Harrisville	Plain Grove, Portersville, Slippery Rock, Volant, West Sunbury, Wesley, Harrisville, Grove City
Hewitt	Cumberland, Md., Flintstone, Md., Hewitt, Oldtown, Md., Ridgeley, W. Va., State Line
Hopewell	Everett, Hopewell, Saxton
Howard	Beech Creek, Bellefonte, Howard, State College, Zion

EXHIBIT 4 - COMPETITIVE LOCAL EXCHANGE

CenturyTel Broadband Services, Inc.

Supplement No. 1
Telephone Pa. P.U.C. Tariff No. 1
Section 5
Original Page 67

Issued: August xx, 2021
Effective: September yy, 2021

Competitive Local Exchange Telecommunications Services

5. Exchange Services

5.1 Exchange Areas

5.1.2 Incumbent Local Exchange Carrier Exchange Areas and Local Calling Areas (LCA)

H. United Telephone Co. of PA Exchange Areas and Local Calling Areas (Cont'd)

Exchange Area	Exchange, Zone or Wire Center Included in the Local Calling Area
Hyndman	Bedford, Bedford Valley, Hyndman
Ickesburg	Ickesburg, Loysville, Millerstown, New Bloomfield, Newport, Port Royal
Littlestown	Gettysburg, Hanover, Littlestown, New Oxford, Silver Run, Md.
Liverpool	Liverpool, Millerstown, Newport
Loysburg	Loysburg, Martinsburg, Roaring Spring
Loysville	Blain, Ickesburg, Loysville, New Bloomfield
Marietta	Columbia, Elizabethtown, Lancaster, Marietta, Mt. Joy, Mountville
Marion	Chambersburg, Greencastle, Marion
Marklesburg	McConnellstown, Huntingdon, Marklesburg
Martinsburg	Altoona , Hollidaysburg, Loysburg, Martinsburg, Roaring Spring, Williamsburg
Marysville	Duncannon, Harrisburg Zone 1, Marysville

EXHIBIT 4 - COMPETITIVE LOCAL EXCHANGE

CenturyTel Broadband Services, Inc.

Supplement No. 1
Telephone Pa. P.U.C. Tariff No. 1
Section 5
Original Page 68

Issued: August xx, 2021
Effective: September yy, 2021

Competitive Local Exchange Telecommunications Services

5. Exchange Services

5.1 Exchange Areas

5.1.2 Incumbent Local Exchange Carrier Exchange Areas and Local Calling Areas (LCA)

H. United Telephone Co. of PA Exchange Areas and Local Calling Areas (Cont'd)

Exchange Area	Exchange, Zone or Wire Center Included in the Local Calling Area
McAlisterville	McAlisterville, Mifflintown, Port Royal, Richfield, Thompsontown
McConnellstown	Alexandria , Huntingdon, Mount Union, Marklesburg, McConnellstown
McConnellsburg	McConnellsburg
Mercersburg	Chambersburg, Greencastle, Marion, Mercersburg, Saint Thomas
Meridian	Butler, Connoquenessing, Nixon, Prospect, Meridian
Mifflintown	East Waterford, Lewistown, McAlisterville, Mifflintown, Port Royal, Thompsontown
Millerstown	Ickesburg, Liverpool, Millerstown, New Bloomfield, Newport, Thompsontown
Mill Hall	Beech Creek, Lock Haven, Mill Hall
Mount Joy	Mount Joy, Columbia, Elizabethtown, Marietta, Mountville, Lancaster, Landisville, Manheim
Mountville	Mountville, Columbia, Marietta, Millersville, Mount Joy, Lancaster, Landisville

EXHIBIT 4 - COMPETITIVE LOCAL EXCHANGE

CenturyTel Broadband Services, Inc.

Supplement No. 1
Telephone Pa. P.U.C. Tariff No. 1
Section 5
Original Page 69

Issued: August xx, 2021
Effective: September yy, 2021

Competitive Local Exchange Telecommunications Services

5. Exchange Services

5.1 Exchange Areas

5.1.2 Incumbent Local Exchange Carrier Exchange Areas and Local Calling Areas (LCA)

H. United Telephone Co. of PA Exchange Areas and Local Calling Areas (Cont'd)

Exchange Area	Exchange, Zone or Wire Center Included in the Local Calling Area
Mt. Holly Springs	Carlisle, Mt. Holly Springs
New Bloomfield	Duncannon, Ickesburg, Loysville, Millerstown, New Bloomfield, Newport
New Oxford	East Berlin, Hanover, Littlestown, New Oxford, Gettysburg
Newburg	Chambersburg, Newburg, Newville, Shippensburg
Newport	Duncannon, Ickesburg, Liverpool, Millerstown, New Bloomfield, Newport
Newville	Carlisle, Newburg, Newville
Nixon	Butler, Connoquenessing, Evans City, Meridian, Nixon, Saxonburg
North Washington	Bruin, Butler, Chicora, Eau Claire, Petrolia, West Sunbury, North Washington
Orbisonia	Orbisonia, Mt. Union, Shade Gap, Three Springs
Osterburg	Bedford, Claysburg, Fishertown, Osterburg

EXHIBIT 4 - COMPETITIVE LOCAL EXCHANGE

CenturyTel Broadband Services, Inc.

Supplement No. 1
Telephone Pa. P.U.C. Tariff No. 1
Section 5
Original Page 70

Issued: August xx, 2021
Effective: September yy, 2021

Competitive Local Exchange Telecommunications Services

5. Exchange Services

5.1 Exchange Areas

5.1.2 Incumbent Local Exchange Carrier Exchange Areas and Local Calling Areas (LCA)

H. United Telephone Co. of PA Exchange Areas and Local Calling Areas (Cont'd)

Exchange Area	Exchange, Zone or Wire Center Included in the Local Calling Area
Parker	Bruin, Eau Claire, Emlenton, Foxburg, Petrolia, Callensburg , Parker
Petrolia	Bruin, Butler, Chicora, North Washington, Parker, Petrolia
Plain Grove	Harrisville, Portersville, Slippery Rock, Volant, Blacktown, Grove City
Portersville	Butler, Harrisville, Plain Grove, Prospect, Volant, Slippery Rock, Princeton, Elwood City, Portersville, Zelienople
Port Royal	East Waterford, Ickesburg, Lewistown, McAlisterville, Mifflintown, Port Royal, Thompsontown
Prospect	Butler, Connoquenessing, Meridian, Portersville, Prospect
Reedsville	Belleville, Lewistown, Reedsville
Richfield	McAlisterville, Mt. Pleasant Mills, Richfield
Roaring Spring	Altoona, Claysburg, Hollidaysburg, Loysburg, Martinsburg, Roaring Spring

EXHIBIT 4 - COMPETITIVE LOCAL EXCHANGE

CenturyTel Broadband Services, Inc.

Supplement No. 1
Telephone Pa. P.U.C. Tariff No. 1
Section 5
Original Page 71

Issued: August xx, 2021
Effective: September yy, 2021

Competitive Local Exchange Telecommunications Services

5. Exchange Services

5.1 Exchange Areas

5.1.2 Incumbent Local Exchange Carrier Exchange Areas and Local Calling Areas (LCA)

H. United Telephone Co. of PA Exchange Areas and Local Calling Areas (Cont'd)

Exchange Area	Exchange, Zone or Wire Center Included in the Local Calling Area
Saint Thomas	Chambersburg, Mercersburg, Saint Thomas
Schellsburg	Bedford, Fishertown, Schellsburg
Shade Gap	Orbisonia, Shade Gap, Three Springs
Shippensburg	Chambersburg, Newburg, Shippensburg
Slippery Rock	Butler, Harrisville, Plain Grove, Portersville, Volant, West Sunbury, Slippery Rock
State Line	Cumberland, Md., Flintstone, Md., Hewitt, Oldtown, Md., Ridgeley, W. Va. State Line
Thompsontown	McAlisterville, Mifflintown, Millerstown, Port Royal, Thompsontown
Three Springs	Orbisonia, Shade Gap, Three Springs, Huntingdon
Volant	Harrisville, Plain Grove, Portersville, Slippery Rock, New Castle, Blacktown, New Wilmington, Volant
Waynesboro	Blue Ridge Summit, Greencastle, Highfield, Md., Waynesboro, Chambersburg
West Sunbury	Butler, Harrisville, North Washington, Slippery Rock, West Sunbury
Williamsburg	Altoona, Hollidaysburg, Martinsburg, Williamsburg
York Springs	Biglerville, Gettysburg, York Springs
Zion	Bellefonte, Howard, State College, Zion

EXHIBIT 4 - COMPETITIVE LOCAL EXCHANGE

CenturyTel Broadband Services, Inc.

Supplement No. 1
Telephone Pa. P.U.C. Tariff No. 1
Section 5
Original Page 72

Issued: August xx, 2021
Effective: September yy, 2021

Competitive Local Exchange Telecommunications Services

5. Exchange Services

5.1 Exchange Areas

5.1.2 Incumbent Local Exchange Carrier Exchange Areas and Local Calling Areas (LCA) (Cont'd)

I. Windstream Pennsylvania, Inc. Exchange Areas and Local Calling Areas

Exchange Area	Exchange, Zone or Wire Center Included in the Local Calling Area
Albion	Albion, Fairview, Erie, Girard and West Springfield
Apollo	Apollo, Leechburg and Vandergrift
Bobtown	Bobtown, Carmichaels, Greensboro, Mt. Morris and Mt. Morris, W. Va.
Brave	Brave, Rogersville, Spraggs, Waynesburg, New Freeport, Graysville, and Blacksville, W.Va.
Brockway	Brockway, DuBois and Falls Creek
Brookville	Brookville, Corsica, Hazen, Sigel and Summerville
Callensburg	Callensburg, Clarion , Knox, Parker, Rimersburg and Sligo
Carmichaels	Bobtown, Carmichaels, Fredericktown, Greensboro, Jefferson, Mt. Morris, Rices Landing, Mt. Morris, W.Va., and Waynesburg
Coalport	Coalport, Glasgow, Altoona, and Houtzdale

EXHIBIT 4 - COMPETITIVE LOCAL EXCHANGE

CenturyTel Broadband Services, Inc.

Supplement No. 1

Telephone Pa. P.U.C. Tariff No. 1

Issued: August xx, 2021

Section 5

Effective: September yy, 2021

Original Page 73

Competitive Local Exchange Telecommunications Services

5. Exchange Services

5.1 Exchange Areas

5.1.2 Incumbent Local Exchange Carrier Exchange Areas and Local Calling Areas (LCA)

I. Windstream Pennsylvania, Inc. Exchange Areas and Local Calling Areas (Cont'd)

Exchange Area	Exchange, Zone or Wire Center Included in the Local Calling Area
Cochranton	Cochranton, Conneaut Lake, Conneautville, Fredonia, Guys Mills, Linesville, Meadville, Sandy Lake, Saegertown, Sheakleyville, and Townville
Colver	Colver, Barnesboro, Carrolltown, Ebensburg, Johnstown, Nanty Glo, and South Fork
Conneaut Lake	Cochranton, Conneaut Lake, Conneautville, Guys Mills, Linesville, Meadville, Saegertown, and Townville
Conneautville	Cochranton, Conneaut Lake, Conneautville, Guys Mills, Linesville, Meadville, Saegertown, and Townville
Corsica	Corsica, Brookville, Clarion, Hazen, Sigel, Strattanville, Summerville
Darlington	Darlington, Beaver Falls, Enon Valley, and Rochester
Dayton	Dayton, Timblin, Kittanning and Rural Valley
Delmont	Delmont, Export, Harrison City, Greensburg, and New Alexandria
Driftwood	Driftwood and Emporium
East Brady	East Brady, Kittanning, Petrolia, and Rimersburg
Elderton	Elderton, Kittanning and Indiana
Emporium	Emporium and Driftwood
Enon Valley	Enon Valley, Beaver Falls, Darlington, New Castle, and Rochester

EXHIBIT 4 - COMPETITIVE LOCAL EXCHANGE

CenturyTel Broadband Services, Inc.

Supplement No. 1
Telephone Pa. P.U.C. Tariff No. 1
Section 5
Original Page 74

Issued: August xx, 2021
Effective: September yy, 2021

Competitive Local Exchange Telecommunications Services

5. Exchange Services

5.1 Exchange Areas

5.1.2 Incumbent Local Exchange Carrier Exchange Areas and Local Calling Areas (LCA)

I. Windstream Pennsylvania, Inc. Exchange Areas and Local Calling Areas (Cont'd)

Exchange Area	Exchange, Zone or Wire Center Included in the Local Calling Area
Export	Export, Harrison City, and Delmont,; Pittsburgh Suburban Zone 21 (Penn Hills), Pittsburgh Suburban Zone 22A (Turtle Creek), and Pittsburgh Suburban Zone 22B (Monroeville)
Ford City	Ford City, Kittanning and Worthington
Fredericktown	Carmichaels, Fredericktown, Greensboro, Jefferson, Rices Landing, and Marianna
Fredonia	Cochranton, Fredonia, Greenville, Sandy Lake, Sheakleyville, and Mercer
Glasgow	Coalport, Glasgow, and Altoona
Graysville	Brave, Graysville, New Freeport, Rogersville, Spraggs, Waynesburg, and Blacksville, W. Va.
Greensboro	Bobtown, Carmichaels, Fredericktown, Greensboro, Jefferson, Mt. Morris, Mt. Morris W. Va., and Rices Landing and Waynesburg
Guys Mills	Cochranton, Conneaut Lake, Conneautville, Guys Mills, Linesville, Meadville, Saegertown, and Townville
Harrison City	Export, Harrison City, Delmont, Irwin, Jeannette and Pittsburgh Suburban Zone 22B (Monroeville)
Hawthorn	Hawthorn, New Bethlehem and Summerville

EXHIBIT 4 - COMPETITIVE LOCAL EXCHANGE

CenturyTel Broadband Services, Inc.

Supplement No. 1
Telephone Pa. P.U.C. Tariff No. 1
Section 5
Original Page 75

Issued: August xx, 2021
Effective: September yy, 2021

Competitive Local Exchange Telecommunications Services

5. Exchange Services

5.1 Exchange Areas

5.1.2 Incumbent Local Exchange Carrier Exchange Areas and Local Calling Areas (LCA)

I. Windstream Pennsylvania, Inc. Exchange Areas and Local Calling Areas (Cont'd)

Exchange Area	Exchange, Zone or Wire Center Included in the Local Calling Area
Hazen	Hazen, Brockway, Brookville, Corsica, Dubois, Sigel, and Summerville
Hughesville	Hughesville, Muncy, and Williamsport
Jamestown	Jamestown, Conneaut Lake, Linesville, Meadville, Westford, and Greenville
Jefferson	Carmichaels, Fredericktown, Greensboro, Jefferson, Rices Landing, and Waynesburg
Johnsonburg	Johnsonburg, Kersey, Ridgway, St. Marys, Weedville, and Wilcox
Kersey	Johnsonburg, Kersey, Ridgway, St. Marys, Weedville, and Wilcox
Kittanning	East Brady, Elderton, Ford City, Kittanning, Rural Valley, Templeton, Worthington, and Dayton
Knox	Knox, Callensburg, Clarion, Rockland, Shipperville, and Venus
Lansford	Lansford, Nesquehoning and Tamaqua
Leechburg	Apollo, Leechburg, New Kensington, and Vandergrift
Linesville	Cochranton, Conneaut Lake, Conneautville, Guys Mills, Linesville, Meadville, Saegertown, and Townville

EXHIBIT 4 - COMPETITIVE LOCAL EXCHANGE

CenturyTel Broadband Services, Inc.

Supplement No. 1

Telephone Pa. P.U.C. Tariff No. 1

Issued: August xx, 2021

Section 5

Effective: September yy, 2021

Original Page 76

Competitive Local Exchange Telecommunications Services

5. Exchange Services

5.1 Exchange Areas

5.1.2 Incumbent Local Exchange Carrier Exchange Areas and Local Calling Areas (LCA)

I. Windstream Pennsylvania, Inc. Exchange Areas and Local Calling Areas (Cont'd)

Exchange Area	Exchange, Zone or Wire Center Included in the Local Calling Area
Luthersburg	Luthersburg, Dubois, and Sykesville
Meadville	Cochranton, Conneaut Lake, Conneautville, Guys Mills, Meadville, Saegertown, Linesville, Townville, Cambridge Springs
Midway	Midway, Burgettstown, and McDonald
Montgomery	Montgomery, Muncy, Watsontown, and Williamsport
Mount Morris	Bobtown, Carmichaels, Greensboro, Core, Mt. Morris, Mt. Morris, W. Va., and Waynesburg
Muncy	Hughesville, Montgomery, Muncy, and Williamsport
New Alexandria	Delmont, Greensburg, Latrobe, and New Alexandria
New Bethlehem	New Bethlehem, Sligo, and Hawthorn
New Freeport	Brave, Graysville, New Freeport, Rogersville, Spraggs, Waynesburg, Blacksville W. Va., and Hundred, W. Va.
Penfield	Penfield, Weedville, and DuBois
Port Matilda	Port Matilda, Warriors Mark, Bellefonte, and State College
Rices Landing	Carmichaels, Fredericktown, Greensboro, Jefferson, and Rices Landing
Richeyville	Bentleyville, Marianna, Scenery Hill, Richeyville, Brownsville, California, Fredericktown, and Washington

EXHIBIT 4 - COMPETITIVE LOCAL EXCHANGE

CenturyTel Broadband Services, Inc.

Supplement No. 1
Telephone Pa. P.U.C. Tariff No. 1
Section 5
Original Page 77

Issued: August xx, 2021
Effective: September yy, 2021

Competitive Local Exchange Telecommunications Services

5. Exchange Services

5.1 Exchange Areas

5.1.2 Incumbent Local Exchange Carrier Exchange Areas and Local Calling Areas (LCA)

I. Windstream Pennsylvania, Inc. Exchange Areas and Local Calling Areas (Cont'd)

Exchange Area	Exchange, Zone or Wire Center Included in the Local Calling Area
Ridgway	Johnsonburg, Kersey, Ridgway, St. Marys, Weedville, and Wilcox
Rimersburg	Rimersburg, Callensburg, Clarion, East Brady, and Sligo
Rockland	Rockland, Emlenton, Franklin, Knox, and Oil City
Rogersville	Brave, Graysville, New Freeport, Rogersville, Spraggs, Waynesburg, and Blacksville, W. Va.
Rural Valley	Dayton, Kittanning and Rural Valley
Saegertown	Cochranton, Conneaut Lake, Conneautville, Guys Mills, Linesville, Meadville, Townville, Cambridge Springs and Saegertown
Saint Marys	Johnsonburg, Kersey, Ridgway, Saint Marys, Weedville, and Wilcox
Sandy Lake	Cochranton, Fredonia, Sandy Lake, and Sheakleyville
Sheakleyville	Cochranton, Fredonia, Sandy Lake, Sheakleyville, and Greenville
Sheffield	Sheffield and Warren
Shipperville	Shipperville, Clarion, Knox, and Venus
Sigel	Sigel, Brookville, Corsica, Hazen, and Summerville

EXHIBIT 4 - COMPETITIVE LOCAL EXCHANGE

CenturyTel Broadband Services, Inc.

Supplement No. 1

Telephone Pa. P.U.C. Tariff No. 1

Issued: August xx, 2021

Section 5

Effective: September yy, 2021

Original Page 78

Competitive Local Exchange Telecommunications Services

5. Exchange Services

5.1 Exchange Areas

5.1.2 Incumbent Local Exchange Carrier Exchange Areas and Local Calling Areas (LCA)

I. Windstream Pennsylvania, Inc. Exchange Areas and Local Calling Areas (Cont'd)

Exchange Area	Exchange, Zone or Wire Center Included in the Local Calling Area
Spraggs	Brave, Graysville, New Freeport, Rogersville, Spraggs, Waynesburg, and Blacksville, W. Va.
Strattanville	Strattanville, Clarion, and Corsica
Summerville	Summerville, Brookville, Corsica, Hawthorn, Hazen and Sigel
Templeton	Kittanning and Templeton
Timblin	Timblin, Dayton, Hawthorn, New Bethlehem and Punxsutawney
Townville	Cochranon, Conneaut Lake, Conneautville, Guys Mills, Linesville, Meadville, Saegertown, Spartansburg, Townville, Lincolnville, and Titusville
Turbotville	Turbotville, Watsonstown, and Washingtonville
WarriorsMark	Warriors Mark, Port Matilda, Tyrone, and State College
Watsonstown	Montgomery, Turbotville; Milton, Lewisburg and Watsonstown
Waynesburg	Brave, Carmichaels, Graysville, Mount Morris, New Freeport, Rogersville, Spraggs, Blacksville, W. Va., and Waynesburg
Weedville	Johnsonburg, Kersey, Ridgway, St. Marys, Weedville, Wilcox, and Penfield

EXHIBIT 4 - COMPETITIVE LOCAL EXCHANGE

CenturyTel Broadband Services, Inc.

Supplement No. 1
Telephone Pa. P.U.C. Tariff No. 1
Section 5
Original Page 79

Issued: August xx, 2021
Effective: September yy, 2021

Competitive Local Exchange Telecommunications Services

5. Exchange Services

5.1 Exchange Areas

5.1.2 Incumbent Local Exchange Carrier Exchange Areas and Local Calling Areas (LCA)

I. Windstream Pennsylvania, Inc. Exchange Areas and Local Calling Areas (Cont'd)

Exchange Area	Exchange, Zone or Wire Center Included in the Local Calling Area
Westford	Conneaut Lake, Jamestown, Linesville, Meadville, and Westford
West Springfield	West Springfield, Albion, Erie, Fairview, and Girard
Wilcox	Johnsonburg, Kersey, Ridgway, St. Marys, Weedville, and Wilcox
Worthington	Butler, Ford City, Kittanning, and Worthington

J. Frontier Communications of Breezewood Exchange Areas and Local Calling Areas

Exchange Area	Exchange, Zone or Wire Center Included in the Local Calling Area
Breezewood	Breezewood, New Granada, Everett (United d/b/a CenturyLink)
Needmore	Needmore, Warfordsburg, Hancock MD (C&P of MD)
New Granada	New Granada, Breezewood
Warfordsburg	Needmore, Warfordsburg, Hancock MD (C&P of MD)

EXHIBIT 4 - COMPETITIVE LOCAL EXCHANGE

CenturyTel Broadband Services, Inc.

Supplement No. 1
Telephone Pa. P.U.C. Tariff No. 1
Section 5
Original Page 80

Issued: August xx, 2021
Effective: September yy, 2021

Competitive Local Exchange Telecommunications Services

5. Exchange Services

5.1 Exchange Areas

5.1.2 Incumbent Local Exchange Carrier Exchange Areas and Local Calling Areas (LCA) (Cont'd)

K. Frontier Communications of Lakewood Exchange Areas and Local Calling Areas

Exchange Area	Exchange, Zone or Wire Center Included in the Local Calling Area
Lakewood	Lakewood, Mahanoy City, Tamaqua (Verizon PA)
Mahanoy City	Lakewood, Mahanoy City, Tamaqua (Verizon PA)
Tamaqua	Lakewood, Mahanoy City, Tamaqua (Verizon PA)

L. Palmerton Telephone Company Exchange Areas and Local Calling Areas

Exchange Area	Exchange, Zone or Wire Center Included in the Local Calling Area
Bowmanstown	Bowmanstown, Kresgeville, Kunkletown, Palmerton, Lehighon, Slatington
Kresgeville	Bowmanstown, Kresgeville, Kunkletown, Palmerton, Saylorsburg, Stroudsburg
Kunkletown	Bowmanstown, Kresgeville, Kunkletown, Palmerton, Saylorsburg, Stroudsburg
Palmerton	Bowmanstown, Kresgeville, Kunkletown, Allentown, Slatington, Lehighon, Palmerton

EXHIBIT 4 - COMPETITIVE LOCAL EXCHANGE

CenturyTel Broadband Services, Inc.

Supplement No. 1
Telephone Pa. P.U.C. Tariff No. 1
Section 5
Original Page 81

Issued: August xx, 2021
Effective: September yy, 2021

Competitive Local Exchange Telecommunications Services

5. Exchange Services

5.1 Exchange Areas

5.1.2 Incumbent Local Exchange Carrier Exchange Areas and Local Calling Areas (LCA) (Cont'd)

M. Denver & Ephrata Telephone Company Exchange Areas and Local Calling Areas

Exchange Area	Exchange, Zone or Wire Center Included in the Local Calling Area
Adamstown	Adamstown, Akron, Denver, Ephrata, Lititz, Manheim, Terre Hill, Reading
Akron	Adamstown, Akron, Denver, Ephrata, Lititz, Manheim, Leola, New Holland, Terre Hill, Lancaster
Denver	Akron, Adamstown, Denver, Ephrata, Lititz, Manheim, Terre Hill
Ephrata	Akron, Adamstown, Denver, Ephrata, Lititz, Manheim, Leola, New Holland, Terre Hill, Lancaster
Lititz	Adamstown, Akron, Denver, Ephrata, Lititz, Manheim, Leola, Lancaster, Landisville
Manheim	Adamstown, Akron, Denver, Ephrata, Lititz, Manheim, Mt. Joy, Lancaster, Landisville

N. Buffalo Valley Telephone Company Territory Exchange Areas and Local Calling Areas

Exchange Area	Exchange, Zone or Wire Center Included in the Local Calling Area
Lewisburg	Lewisburg, Mifflinburg, Milton (Verizon PA)
Mifflinburg	Lewisburg, Mifflinburg, Milton (Verizon PA)

EXHIBIT 4 - COMPETITIVE LOCAL EXCHANGE

CenturyTel Broadband Services, Inc.

Supplement No. 1
Telephone Pa. P.U.C. Tariff No. 1
Section 5
Original Page 82

Issued: August xx, 2021
Effective: September yy, 2021

Competitive Local Exchange Telecommunications Services

5. Exchange Services

5.1 Exchange Areas

5.1.2 Incumbent Local Exchange Carrier Exchange Areas and Local Calling Areas (LCA) (Cont'd)

O. Frontier Communications of Pennsylvania Exchange Areas and Local Calling Areas

Exchange Area	Exchange, Zone or Wire Center Included in the Local Calling Area
Intercourse	Intercourse, Leola, New Holland, Terre Hill, Gap (Commonwealth Tel. Co.), Lancaster, Strasburg (Verizon)
Leola	Intercourse, Leola, New Holland, Terre Hill, Akron, Ephrata, Lititz (Denver & Ephrata Tel. Co.); Lancaster (Verizon)
New Holland	Intercourse, Leola, New Holland, Terre Hill; Akron, Ephrata (Denver & Ephrata Tel. Co.); Lancaster (Verizon)
Terre Hill	Intercourse, Leola, New Holland, Terre Hill; Adamstown, Akron, Denver, Ephrata (Denver & Ephrata Tel. Co.); Green Hills, Morgantown (Conestoga Tel. & Tel. Co.)

P. Armstrong Telephone Company (Murdocksville Independent) Exchange Areas and Local Calling Areas

Exchange Area	Exchange, Zone or Wire Center Included in the Local Calling Area
Clinton	Clinton, Murdocksville
Murdocksville	Clinton, Murdocksville

EXHIBIT 4 - COMPETITIVE LOCAL EXCHANGE

CenturyTel Broadband Services, Inc.

Supplement No. 1

Telephone Pa. P.U.C. Tariff No. 1

Issued: August xx, 2021

Section 5

Effective: September yy, 2021

Original Page 83

Competitive Local Exchange Telecommunications Services

5. Exchange Services

5.1 Exchange Areas

5.1.2 Incumbent Local Exchange Carrier Exchange Areas and Local Calling Areas (LCA) (Cont'd)

Q. Conestoga Telephone & Telegraph Company Exchange Areas and Local Calling Areas

Exchange Area	Exchange, Zone or Wire Center Included in the Local Calling Area
Bally	Bally, Boyertown, Oley, Sassamansville, Topton, Yellow House; Allentown, Pennsburg, Pottstown (Verizon PA)
Birdsboro	Birdsboro, Douglassville, Green Hills, Morgantown, Oley, Yellow House; Pottstown, Reading (Verizon PA)
Boyertown	Boyertown, Bally, Douglassville, Oley, Sassamansville, Yellow House; Pottstown, Reading (Verizon PA)
Douglassville	Douglassville, Birdsboro, Boyertown, Green Hills, Morgantown, Oley, Yellow House; Pottstown, Reading (Verizon PA)
Green Hills	Green Hills, Birdsboro, Douglassville, Morgantown, Oley, Yellow House; Glenmoore, Honeybrook, Pughtown, Reading (Verizon PA); Terre Hill (Enterprise Tel.)
Morgantown	Morgantown, Birdsboro, Douglassville, Green Hills; Downingtown, Eagle, Exton, Chester Springs, Glenmoore, Honeybrook, Pughtown, Reading (Verizon PA); Terre Hill (Enterprise Tel.)
Oley	Oley, Bally, Birdsboro, Boyertown, Douglassville, Green Hills, Topton, Yellow House; Fleetwood, Reading (Verizon PA)
Sassamansville	Sassamansville, Bally, Boyertown; Green Lane, Pennsburg, Pottstown, Schwenksville (Verizon PA)
Topton	Topton, Bally, Oley; Allentown, Fleetwood, Kutztown, Reading (Verizon PA)
Yellow House	Yellow House, Bally, Birdsboro, Boyertown, Douglassville, Green Hills, Oley; Pottstown, Reading (Verizon PA)

EXHIBIT 4 - COMPETITIVE LOCAL EXCHANGE

CenturyTel Broadband Services, Inc.

Supplement No. 1
Telephone Pa. P.U.C. Tariff No. 1
Section 5
Original Page 84

Issued: August xx, 2021
Effective: September yy, 2021

Competitive Local Exchange Telecommunications Services

5. Exchange Services

5.1 Exchange Areas

5.1.2 Incumbent Local Exchange Carrier Exchange Areas and Local Calling Areas (LCA) (Cont'd)

R. Laurel Highland Telephone Company Exchange Areas and Local Calling Areas

Exchange Area	Exchange, Zone or Wire Center Included in the Local Calling Area
Stahlstown	Indian Head, Ligonier (Verizon PA), Stahlstown
Indian Head	Stahlstown, Connellsville (Verizon PA), Indian Head

S. Pymatuning Independent Telephone Company Exchange Areas and Local Calling Areas

Exchange Area	Exchange, Zone or Wire Center Included in the Local Calling Area
Transfer	Greensville, Sharpsville, Sharon (Verizon), Transfer

T. Service Area of Incumbent Local Exchange Carrier: Armstrong Telephone Company North Territory

Exchange Area	Exchange, Zone or Wire Center Included in the Local Calling Area
Duke Center	Duke Center, Gradford, Eldred, Rew (Verizon PA)

EXHIBIT 4 - COMPETITIVE LOCAL EXCHANGE

CenturyTel Broadband Services, Inc.

Supplement No. 1
Telephone Pa. P.U.C. Tariff No. 1
Section 5
Original Page 85

Issued: August xx, 2021
Effective: September yy, 2021

Competitive Local Exchange Telecommunications Services

5. Exchange Services

5.1 Exchange Areas

5.1.2 Incumbent Local Exchange Carrier Exchange Areas and Local Calling Areas (LCA) (Cont'd)

U. Citizens Telephone Company of Kecksburg Exchange Areas and Local Calling Areas

Exchange Area	Exchange, Zone or Wire Center Included in the Local Calling Area
Kecksburg	Kecksburg (Citizens Tel. Co. of Kecksburg), Mt. Pleasant, Latrobe, Greensburg (Verizon PA)

V. Frontier Communications of Canton, LLC Exchange Areas and Local Calling Areas

Exchange Area	Exchange, Zone or Wire Center Included in the Local Calling Area
Canton Leroy	Canton, Leroy, Troy (Commonwealth Tel. Co.) Canton, Leroy, Troy, Towanda (Commonwealth Tel. Co.)

W. Citizens Telecom Company of New York Exchange Areas and Local Calling Areas

Exchange Area	Exchange, Zone or Wire Center Included in the Local Calling Area
Little Meadows	Appalachin, NY; Endicott, NY; Owego, NY (Verizon); Little Meadows
Quaker Lake	Binghamton, NY (Verizon); Hawleytown, NY; Quaker Lake

EXHIBIT 4 - COMPETITIVE LOCAL EXCHANGE

CenturyTel Broadband Services, Inc.

Supplement No. 1
Telephone Pa. P.U.C. Tariff No. 1
Section 5
Original Page 86

Issued: August xx, 2021
Effective: September yy, 2021

Competitive Local Exchange Telecommunications Services

5. Exchange Services

5.1 Exchange Areas

5.1.2 Incumbent Local Exchange Carrier Exchange Areas and Local Calling Areas (LCA) (Cont'd)

X. Lackawaxen Telephone Company Exchange Areas and Local Calling Areas

Exchange Area	Exchange, Zone or Wire Center Included in the Local Calling Area
---------------	---

Rowland	Rowland
---------	---------

Y. North Penn Telephone Company T Exchange Areas and Local Calling Areas

Exchange Area	Exchange, Zone or Wire Center Included in the Local Calling Area
---------------	---

Bentley Creek	Bentley Creek
Millerton	Millerton
Roseville	Roseville, Mansfield

Z. South Canaan Telephone Company Exchange Areas and Local Calling Areas

Exchange Area	Exchange, Zone or Wire Center Included in the Local Calling Area
---------------	---

South Canaan	South Canaan, Waymart, Carbondale, Hamlin, Honesdale, Lake Ariel (Bell of Pennsylvania)
Waymart	South Canaan, Waymart, Carbondale, Honesdale, Lake Ariel (Bell of Pennsylvania)

AA. TDS Telecom/Mahonoy & Mahantango Telephone Company T Exchange Areas and Local Calling Areas

Exchange Area	Exchange, Zone or Wire Center Included in the Local Calling Area
---------------	---

Leck Kill	Leck Kill, Trevorton
Mandata	Mandata, Trevorton
Trevorton	Mandata, Shamokin (Verizon), Trevorton

EXHIBIT 4 - COMPETITIVE LOCAL EXCHANGE

CenturyTel Broadband Services, Inc.

Supplement No. 1
Telephone Pa. P.U.C. Tariff No. 1
Section 6
Original Page 1

Issued: August xx, 2021
Effective: September yy, 2021

Competitive Local Exchange Telecommunications Services

6. Voice Offerings

6.1 Connected Voice

6.1.1 Description

- A. Connected Voice is a VoIP (Voice over Internet Protocol) service available to single line business and residence customers. Connected Voice provides inbound calling and unlimited local and domestic long distance direct-dialed outbound calling utilizing an Internet Protocol (IP) to IP or Public Switched Telephone Network (PSTN) to IP (or vice-versa) hand-off and which Customer certifies to Company is either originated by Subscribers in or terminated to Subscribers via an IP format (or is otherwise enhanced traffic). Company will route calls to the PSTN or an IP address and terminate them to a Customer Voice over Internet Protocol (VoIP) Application. The following calling features are included:

- Caller Identification
- Three-Way Calling
- Anonymous Call Block
- Call Forwarding
- Call Waiting/Cancel Call Waiting
- Call Hold
- Do Not Disturb (block all calls)

- B. Internet or data connectivity and compatible analog or digital phones are required.
- C. Connected Voice is offered for a minimum service term of one month.

6.1.2 Rates

Per Line \$40.00

EXHIBIT 4 - COMPETITIVE LOCAL EXCHANGE

CenturyTel Broadband Services, Inc.

Supplement No. 1
Telephone Pa. P.U.C. Tariff No. 1
Section 6
Original Page 2

Issued: August xx, 2021
Effective: September yy, 2021

Competitive Local Exchange Telecommunications Services

6. Voice Offerings

6.2 Federal Lifeline Assistance Program

6.2.2 Description

A. Description

The Federal Lifeline Program assists qualified low-income applicants with reductions in their monthly Local Exchange Service rate. The assistance applies to a single telephone line or broadband service, or a bundle of broadband and single telephone line service at the applicant's principal place of residence.

B. Eligibility Requirements

To receive assistance an applicant must demonstrate an annual household income at or below 135 percent of the federal poverty guidelines, or must demonstrate participation by the applicant, applicant's dependent(s) or a member of applicant's household ^[1] in one of the following programs:

- Federal Public Housing Assistance (FPHA) or Section 8
- Medicaid
- Supplemental Nutrition Assistance Program (SNAP)
- Supplemental Security Income (SSI)
- Veterans Pension benefit and Survivors Pension

C. Terms and Conditions

1. An applicant may request Lifeline assistance directly through the on-line consumer portal of the National Lifeline Eligibility Verifier (NLEV), also known as National Verifier. Applicants may also mail a completed paper application, Household Worksheet, and proof of eligibility to the Lifeline Support Center. Applicants may contact the Company to request that paper copies of the application and Household Worksheet be mailed to them or may obtain the required forms from the following website: <https://www.lifelinesupport.org/lv/nv/default.aspx>.

Customers may also contact USAC at <https://www.usac.org/lifeline/contact-us/> or by telephone at 1-800-234-9476 to request a paper Lifeline application or household worksheet.

2. The Federal Lifeline Program credit may be applied to any qualifying residential Local Exchange Service provided by the Company (including Packaged Services).

^[1] A household is defined, for purposes of administering this program, as any individual or group of individuals who live together at the same address and share income and expenses.

EXHIBIT 4 - COMPETITIVE LOCAL EXCHANGE

CenturyTel Broadband Services, Inc.

Supplement No. 1

Telephone Pa. P.U.C. Tariff No. 1

Issued: August xx, 2021

Section 6

Effective: September yy, 2021

Original Page 3

Competitive Local Exchange Telecommunications Services

6. Voice Offerings

6.2 Federal Lifeline Assistance Program

6.2.2 Description

C. Terms and Conditions (Continued)

3. Customers are limited to one credit per household, which may be applied towards a qualifying wireline service, a qualifying broadband service or a qualifying bundled voice and data service package. Customers are not eligible to receive a credit from the Company if they receive a Federal Lifeline Program credit for a service provided by another Eligible Telecommunications Carrier or Lifeline Broadband Provider.
4. The Federal Lifeline Program credit will begin with the first billing date after the Company is notified by applicants who qualify for benefits or when new service is established by a qualifying customer.
5. Applicants must provide proof of eligibility and be deemed eligible for participation before monthly credits begin. Credits will only be issued on a go-forward basis.
6. Nonrecurring charges will not apply when establishing this program on existing service.
7. Partial payments made by Lifeline customers will be applied first towards local service charges.
8. The discount shall be applied first to the subscriber line charge, and then to the monthly service rate for Lifeline eligible services.
9. At no time shall the total Lifeline discount exceed the sum of the subscriber line charge and the monthly service rate, excluding applicable taxes, fees, and other surcharges.
10. All Lifeline recipients will be required to recertify their eligibility every year.
11. Toll and Casual Dialing Restriction (also known as Toll Blocking) is available to Lifeline customers upon request at no charge. No service deposit will be required for applicants who voluntarily elect toll restriction with the initiation of Lifeline service.

Any Lifeline customer who has a past due balance in toll message charges will be automatically restricted from access to toll services until the outstanding balance is paid. The customer will not be charged for the toll restriction placed on the account. The Restoration Charge applies to Lifeline customers whose message toll service has been restricted for nonpayment.

If a Lifeline customer is toll restricted for a second occurrence, the Company may, at its discretion, place the Lifeline customer on a permanent toll restriction. A Lifeline subscriber's request for reconnection or re-establishment of local service will not be denied if the service was previously suspended or disconnected for non-payment of toll charges.

EXHIBIT 4 - COMPETITIVE LOCAL EXCHANGE

CenturyTel Broadband Services, Inc.

Supplement No. 1
Telephone Pa. P.U.C. Tariff No. 1
Section 6
Original Page 3

Issued: August xx, 2021
Effective: September yy, 2021

Competitive Local Exchange Telecommunications Services

6. Voice Offerings

6.2 Federal Lifeline Assistance Program

6.2.2 Description (Cont'd)

D. Monthly Credit

	<u>Credit Amount</u>
Federal Lifeline Program Credit, per month	
• Qualifying voice-only service	
- Voice-only credit amount as of December 1, 2020	\$5.25
- Voice-only credit amount in eligible Census blocks ^[1] as of December 1, 2021	\$5.25
- Voice-only credit amount in non-eligible Census blocks ^[1] as of December 1, 2021	\$0.00
• Qualifying Broadband or bundled service	\$9.25

^[1] Effective December 1, 2021, the federal lifeline credit for a qualifying voice-only service is available only to customers residing in eligible Census blocks. This mandate is per the public notice which was released on June 1, 2021 (**updated on July 29, 2021**). In the Third Report and Order, Further Report and Order, and Order on Reconsideration ("Order"), (Docket No.s 11-42, 09-197, 10-90), released on April 27, 2016 as FCC 16-38 and published in the Federal Register on May 24, 2016 - the FCC ordered the annual release of updated exception Census blocks. These identified Census blocks where ETCs can continue to claim \$5.25 in reimbursement for voice-only Lifeline services offered to eligible subscribers after December 1, 2021 can be found at: https://www.usac.org/wp-content/uploads/lifeline/documents/Data/voice_CB_blocks.zip.

EXHIBIT 4 - COMPETITIVE LOCAL EXCHANGE

CenturyTel Broadband Services, Inc.

Supplement No. 1
Telephone Pa. P.U.C. Tariff No. 1
Section 7
Original Page 1

Issued: August xx, 2021
Effective: September yy, 2021

Competitive Local Exchange Telecommunications Services

7. Reserved for Future Use

EXHIBIT 4 - COMPETITIVE LOCAL EXCHANGE

CenturyTel Broadband Services, Inc.

Supplement No. 1
Telephone Pa. P.U.C. Tariff No. 1
Section 8
Original Page 1

Issued: August xx, 2021
Effective: September yy, 2021

Competitive Local Exchange Telecommunications Services

8. Integrated Services Digital Network

8.1 Primary Rate Service Offerings

8.1.1 ISDN Primary Rate Interface (PRI)

A. Description

Qwest Integrated Services Digital Network Primary Rate Interface (ISDN PRI) is a digital business service that provides PBX equipment and host computer access to a wide variety of switched services. These switched services include circuit switched voice (local calling, Message Toll Service (MTS), 800 and circuit switched data). Each Qwest ISDN PRI will allow connection of the aforementioned services via a single central office connection. This service allows PBX equipment and host computer type devices to connect to central office services in bulk quantity, rather than on a line by line or service by service basis.

Each Qwest ISDN PRI connection provides access from a Customer premises to the Company's circuit switched voice and circuit switched data via a 1.544 Mbps central office port termination and a 1.544 Mbps Digital Local Loop to the Customer's premises. The Digital Local Loop is a DS1 with Clear Channel Capability. The central office port connection is provided in base capacities of twenty-three 64 Kbps "B" channels and one 64 Kbps "D" channel (23B+D), plus a twenty-four 64 Kbps "B" Channels (24B), plus twenty-three 64 Kbps "B" Channels and one 64 Kbps Backup "D" channel (23B+BuD). The "D" channel is used for out-of-band signaling and control of the "B" channels. Where technology permits, "D" channels can be shared by multiple ISDN PRI's for the same Customer. "B" channels can be dedicated to each circuit switched voice and circuit switched data service by type or they can be shared among service types by using the call by call feature.

All Customer Provided Equipment is the responsibility of the customer.

B. Definitions

"B" Channel - "B" Channel (Bearer Channel) is a 64 Kbps digital channel capable of transporting circuit switched voice and circuit switched data.

"D" Channel - "D" Channel (Delta Channel) is a 64 Kbps digital channel used to transport signaling and control the B channels.

Out of Band Signaling - Out of Band Signaling is signaling that is separated from the channel carrying the circuit switched voice and data services.

EXHIBIT 4 - COMPETITIVE LOCAL EXCHANGE

CenturyTel Broadband Services, Inc.

Supplement No. 1
Telephone Pa. P.U.C. Tariff No. 1
Section 8
Original Page 2

Issued: August xx, 2021
Effective: September yy, 2021

Competitive Local Exchange Telecommunications Services

8. Integrated Services Digital Network

8.1 Primary Rate Service Offerings

8.1.1 ISDN Primary Rate Interface (PRI)

B. Definitions (Cont'd)

Incoming Calling Line Identification - All calling numbers presented to the services working on ISDN PRI can be delivered to the Customer's CPE, including calls made to Direct Inward Dialing Service telephone numbers. This feature is optioned on a per ISDN PRI Port basis only and is offered in appropriately equipped central offices.

Clear Channel Capability - The "B" channels on the ISDN PRI are clear, since all signaling and control functions are handled by the "D" channel. This allows all 64 Kbps on each "B" channel to be used for Customer information over the ISDN PRI connection. Calls over the network may be either by 56 Kbps or 64 Kbps depending on the public network in place between the ISDN PRI and the distant end of the call.

Digital Voice Transmission - All voice calls are transmitted using digital signaling.

Channel Configuration - Allows some or all B Channels to be dedicated to exchange and MTS, DID, or 800 Services. Multiple dedicated trunk groups can be established on the same Primary port or group of Primary ports.

Direct Inward Dialing (DID) Signal - Permits incoming dialed calls from the exchange network to reach a specific number serviced by Customer-premises equipment (CPE) without the assistance of an attendant. It also provides for the unique identification of the call based on digits sent to the CPE by the central office. The central office will outpulse digits to the CPE which can further process the calls as desired.

Equal Access - Allows the Customer to preselect an Intra and Interexchange Carrier. for each circuit switched voice or circuit switched data trunk group. The carrier designation can be changed for applicable charges as shown in Section 3, Presubscription-2 (PIC) of this Tariff.

EXHIBIT 4 - COMPETITIVE LOCAL EXCHANGE

CenturyTel Broadband Services, Inc.

Supplement No. 1
Telephone Pa. P.U.C. Tariff No. 1
Section 8
Original Page 3

Issued: August xx, 2021
Effective: September yy, 2021

Competitive Local Exchange Telecommunications Services

8. Integrated Services Digital Network

8.1 Primary Rate Service Offerings

8.1.1 ISDN Primary Rate Interface (PRI)

B. Definitions (Cont'd)

Calling Number Delivery - Standard feature which allows for the end user to receive caller ID information.

Circuit-Switched Data Connection - A Circuit-Switched Data Connection is a central office translation that provisions 23 or 24 B-channels on a Qwest ISDN PRI T1 facility. All B-channels are dedicated with 2-way operation and have access to the exchange network. Incoming calls are restricted to circuit-switched data or video.

ISDN Trunk Connection - An ISDN Trunk Connection (TC) is a central office translation that provisions each B-channel in a Qwest ISDN PRI. The TC allows access to the exchange network. One ISDN Trunk Connection is required for each B-channel used in a PRI.

- Dedicated Qwest ISDN PRI
 - Each B-channel is dedicated to inward, outward, or 2-way traffic.

Network Connection - The network connection provides switching to the local exchange and toll networks, and includes the channel trunk-side configuration for the entire DS1 facility.

Calling Number Identification - This feature displays the call identification information and the calling party's DN (including nonpublished and nonlisted DNs) prior to the call being answered. Callers have the ability to inhibit the display of calling party information to the terminating number.

Calling Number Identification Blocking-All Calls - All outgoing calls will be blocked for Qwest ISDN PRI customers where technically feasible as determined by the Company.

EXHIBIT 4 - COMPETITIVE LOCAL EXCHANGE

CenturyTel Broadband Services, Inc.

Supplement No. 1
Telephone Pa. P.U.C. Tariff No. 1
Section 8
Original Page 4

Issued: August xx, 2021
Effective: September yy, 2021

Competitive Local Exchange Telecommunications Services

8. Integrated Services Digital Network

8.1 Primary Rate Service Offerings

8.1.1 ISDN Primary Rate Interface (PRI)

B. Definitions (Cont'd)

Direct Inward/Outward Dialing - Allows station users to place or receive calls by-passing the attendant.

Circuit-Switched Data - Allows the transmission of circuit-switched data on a voice channel.

2B Channel Transfer - 2B Channel Transfer allows the transfer of two independent calls when both calls have been answered or when one call has been answered and one call is alerting. Notification of transfer is given to transferred users.

ISDN Redirecting Number Delivery (RND) - RND provides not only the original calling number, but one or more numbers from which a call was redirected. If a call is redirected multiple times, both the first and the last redirecting numbers will be delivered. On calls forwarded, a redirecting reason is also provided to the RND subscriber indicating why a call was forwarded, e.g., the Call Forwarding Variable, Call Forwarding Busy, or Call Forwarding Don't Answer feature was active. When a call is forwarded multiple times, the first and last redirecting reasons will be provided to the RND subscriber.

C. Terms and Conditions

1. Each Qwest ISDN PRI consists of one T1 facility and one Service Configuration. A customer may request more than one PRI per premises.
2. Terms, conditions, rates and charges, as described for Qwest ISDN PRI are in addition to the regular rates and charges for the service with which Qwest ISDN PRI is associated.
3. Some services are not available and/or compatible with Qwest ISDN PRI.
4. The PRI facility for all channels may be provisioned on an existing or new T3 facility.
5. Qwest ISDN PRI customers must subscribe to a minimum of one 23B+D Service Configuration.

EXHIBIT 4 - COMPETITIVE LOCAL EXCHANGE

CenturyTel Broadband Services, Inc.

Supplement No. 1
Telephone Pa. P.U.C. Tariff No. 1
Section 8
Original Page 5

Issued: August xx, 2021
Effective: September yy, 2021

Competitive Local Exchange Telecommunications Services

8. Integrated Services Digital Network

8.1 Primary Rate Service Offerings

8.1.1 ISDN Primary Rate Interface (PRI)

C. Terms and Conditions (Cont'd)

6. A Direct Inward Dialing (*DID*) Trunk Termination, in 8.1.1.D.2. following, is required for each inward or 2-way B-channel TC in a PRI.
- 7 Circuit-Switched Data Qwest ISDN PRI is only intended for data calls, including video.
8. Cancellation Of Application For Service
 - a. A customer may cancel an order for the installation of service at any time prior to notification by the Company that service is available for the customer's use. The cancellation date is the date the Company receives written or verbal notice from the customer that the order is to be cancelled. Cancellation charges will apply.
 - b. When a customer cancels an order for the discontinuance of service, no charges apply.
 - c. A request for cancellation after completion of an installation will be treated as a discontinuance of service.

EXHIBIT 4 - COMPETITIVE LOCAL EXCHANGE

CenturyTel Broadband Services, Inc.

Supplement No. 1
Telephone Pa. P.U.C. Tariff No. 1
Section 8
Original Page 6

Issued: August xx, 2021
Effective: September yy, 2021

Competitive Local Exchange Telecommunications Services

8. Integrated Services Digital Network

8.1 Primary Rate Service Offerings

8.1.1 ISDN Primary Rate Interface (PRI) (Cont'd)

D. Rates and Charges

Customer will be charged monthly recurring charges for stand alone service and for any additional features and capabilities selected by the customer, and non-recurring charges, as set forth below.

1. Stand Alone Service:

Service configurations are In-Only, Out-Only, or Two-way, 23B+D, and/or 23B + Backup D, and/or 24B, T-1 facility and Common Equipment with 24 channels on a DS1 Facility:

	Maximum Nonrecurring Charge	Maximum Monthly Rate
- Monthly Rate	\$1,000.00	\$1,400.00
- 1-Year Plan	500.00	1,325.00
- 2-Year Plan	500.00	1,250.00
- 3-Year Plan	500.00	1,175.00

In-Only, Out-Only, or Two-way, 23B+D, and/or 23B + Backup D, and/or 24B, T-1 facility and Common Equipment provisioned on a DS3 facility:

	Maximum Nonrecurring Charge	Maximum Monthly Rate
- Monthly Rate	\$1,000.00	\$1,350.00
- 1-Year Plan	500.00	1,275.00
- 2-Year Plan	500.00	1,200.00
- 3-Year Plan	500.00	1,125.00

EXHIBIT 4 - COMPETITIVE LOCAL EXCHANGE

CenturyTel Broadband Services, Inc.

Supplement No. 1
Telephone Pa. P.U.C. Tariff No. 1
Section 8
Original Page 7

Issued: August xx, 2021
Effective: September yy, 2021

Competitive Local Exchange Telecommunications Services

8. Integrated Services Digital Network

8.1 Primary Rate Service Offerings

8.1.1 ISDN Primary Rate Interface (PRI)

D. Rates and Charges (Cont'd)

2. Direct Inward Dialing Numbers

DID subscribers may need to purchase additional features or services to comply with the dispatchable location provisions of RAY BAUM's Act, as described in Section 2.4.1.B. 2.

Service configurations are In-Only, Out-Only, or Two-way, 23B+D, and/or 23B + Backup D, and/or 24B, T-1 facility and Common Equipment with 24 channels.

3. Nonrecurring charges:

Charges will apply for work activities (e.g., installation) associated with the provisioning of this service.

	Maximum Nonrecurring Charge
• All miscellaneous Line changes or trunk group rearrangements, or rearrangements of facilities, per facility	\$ 50.00
• Cancellation Charge	1,500.00
• Rollover Charge	
- Move existing DS1 to DS3 on vacant channels	325.00
• Moving current customer T1 facility	
- Within same central office	500.00
- Outside current central office	1,000.00

EXHIBIT 4 - COMPETITIVE LOCAL EXCHANGE

CenturyTel Broadband Services, Inc.

Supplement No. 1
 Telephone Pa. P.U.C. Tariff No. 1
 Section 8
 Original Page 8

Issued: August xx, 2021
 Effective: September yy, 2021

Competitive Local Exchange Telecommunications Services

8. Integrated Services Digital Network

8.1 Primary Rate Service Offerings

8.1.1 ISDN Primary Rate Interface (PRI)

D. Rates and Charges (Cont'd)

4. Additional Features and Capabilities:

	Maximum Monthly <u>Rate</u>	Maximum Nonrecurring <u>Charge</u>
• Clear channel (per Digital Local Loop)	\$ 0.00	\$ 350.00
• T1/PRI Reconfiguration Charge	0.00	150.00
• System Intercommunication Service, per Trunk Group	35.00	250.00
• Network Ring Again, Per ISDN PRI equipped	75.00	400.00
• Network Name Display, Per ISDN PRI equipped	50.00	250.00
• Circuit-Switched Data Connection, per T1 facility		
- 23B data only channels	700.00	1,250.00
- 24B data only channels	725.00	1,500.00
• Optional Features, per T1 facility		
- 2B Channel Transfer	40.00	100.00
- ISDN Calling Name Delivery	25.00	175.00
- ISDN Redirecting Number Delivery	10.00	75.00

EXHIBIT 4 - COMPETITIVE LOCAL EXCHANGE

CenturyTel Broadband Services, Inc.

Supplement No. 1
Telephone Pa. P.U.C. Tariff No. 1
Section 8
Original Page 9

Issued: August xx, 2021
Effective: September yy, 2021

Competitive Local Exchange Telecommunications Services

8. Integrated Services Digital Network

8.1 Primary Rate Service Offerings

8.1.1 ISDN Primary Rate Interface (PRI)

D. Rates and Charges (Cont'd)

5. Individual Case Basis (ICB) Agreements

The prices, terms and conditions for this service set forth in this Tariff may be negotiated with customers on an ICB basis as established in an individual customer contract.

EXHIBIT 4 - COMPETITIVE LOCAL EXCHANGE

CenturyTel Broadband Services, Inc.

Supplement No. 1
Telephone Pa. P.U.C. Tariff No. 1
Section 9
Original Page 1

Issued: August xx, 2021
Effective: September yy, 2021

Competitive Local Exchange Telecommunications Services

9. Emergency Services

9.1 Telecommunications Service Priority (TSP) Service

A. Description

Telecommunications Service Priority (TSP) Service allows the Company to provision and restore the customer's National Security/Emergency Preparedness (NS/EP) Telecommunications Services with TSP Authorization Codes before services without such assignments as set forth in 47 CFR Part 64, Appendix A. TSP Service is available on Company services that have a unique and identifiable circuit identification number. The service is provided on a per circuit basis and includes Qwest On-Net and Leased Local Access. The underlying NS/EP Telecommunications Service is offered pursuant to the terms and conditions of the Agreement, Service Exhibit, and/or Services Schedule applicable to the service. TSP Service is only available to federal, state and local government users and certain private sector organizations that have services that support an NS/EP function.

B. Conditions

1. The customer must provide the TSP Authorization Code before the Company shall provide service.
2. The Company will not accept TSP assignments or orders without an assigned TSP Authorization Code.
3. TSP restoration priorities must be requested and assigned before a service outage occurs

C. Special Construction

If the customer requires special construction of any kind associated with the TSP, they will be charged a one-time special construction charge determined at the time of such special construction.

EXHIBIT 4 - COMPETITIVE LOCAL EXCHANGE

CenturyTel Broadband Services, Inc.

Supplement No. 1
Telephone Pa. P.U.C. Tariff No. 1
Section 9
Original Page 2

Issued: August xx, 2021
Effective: September yy, 2021

Competitive Local Exchange Telecommunications Services

9. Emergency Services

9.2 Emergency Reporting Services

9.2.1 Enhanced Emergency Number Service (E911)

- A. Enhanced Emergency Number Service (E911) allows Customers to reach appropriate emergency services including police, fire and medical services. Enhanced 911 has the ability to selectively route an emergency call to the primary E911 provider so that it reaches the correct emergency service located closest to the caller. In addition, the Customer's address and telephone information will be displayed to the primary E911 provider for display at the Public Service Answering Point (PSAP).
- B. This service is offered solely as an aid in handling assistance calls in connection with fire, police and other emergencies. The Company is not responsible for any losses, claims, demands, suits or any liability whatsoever, whether suffered, made, instituted or asserted by the Customer or by any other party or person for any personal injury to or death of any person or persons, and for any loss, damage or destruction of any property, whether owned by the Customer or others, caused or claimed to have been caused by: (1) mistakes, omissions, interruptions, delays, errors or other defects in the provision of this service, or (2) installation, operation, failure to operate, maintenance, removal, presence, condition, location or use of any equipment and facilities furnishing this service.
- C. Neither is the Company responsible for any infringement or invasion of the right of privacy of any person or persons, caused or claimed to have been caused, directly or indirectly, by the installation, operation, failure to operate, maintenance, removal, presence, condition, occasion or use of enhanced 911 service features and the equipment associated therewith, or by any services furnished by the Company including, but not limited to, the identification of the telephone number, address or name associated with the telephone used by the party or parties accessing enhanced 911 service, and which arise out of the negligence or other wrongful act of the Company, the Customer, its Users, agencies or municipalities, or the employees or agents of any one of them.
- D. The Company's switched network services enable the Customer to access E911 Emergency Service.

EXHIBIT 4 - COMPETITIVE LOCAL EXCHANGE

CenturyTel Broadband Services, Inc.

Supplement No. 1
Telephone Pa. P.U.C. Tariff No. 1
Section 9
Original Page 3

Issued: August xx, 2021
Effective: September yy, 2021

Competitive Local Exchange Telecommunications Services

9. Emergency Services

9.2 Emergency Reporting Services

9.2.1 Enhanced Emergency Number Service (E911) (Cont'd)

E. Glossary of Terms

Host Telephone Company - the service provider, which is also the telecommunications public utility, that provides 9-1-1 service to the county/municipality and that houses the Automatic Location Identification (ALI)/MSAG data used for providing 9-1-1 service.

Service Provider - a telecommunications public utility regulated by the Pennsylvania Public Utility Commission which has or requests access to the county/municipality 9-1-1 system or connection to the serving selective router including, but not limited to, local exchange carriers and Competitive Local Exchange Telecommunications Services. Qwest Communications Company, LLC is a service provider of E911 service.

Content - the data elements of the MSAG including, but not necessarily limited to, the data elements that are entered into the following fields -I of a standard Master Street Address Guide (MSAG) record:

- A Tax area record
- B Locality
- C Street
- D Thoroughfare
- E Directional [where required]
- F Even (E), odd (O), or all (A) [applied to house numbers]
- G Low-high range of house numbers
- H Public Safety Answering Point (PSAP)
- I Latitude/Longitude (LAT/LONG) [where required]

Formatting, Format - changes to the identity of fields, order of fields, and number and arrangement of data elements in each field, and a telephone company's rearrangement or regrouping of such data, without changing the MSAG content, for purposes of validating against MSAG records.

EXHIBIT 4 - COMPETITIVE LOCAL EXCHANGE

CenturyTel Broadband Services, Inc.

Supplement No. 1
Telephone Pa. P.U.C. Tariff No. 1

Issued: August xx, 2021
Effective: September yy, 2021

Section 9
Original Page 4

Competitive Local Exchange Telecommunications Services

9. Emergency Services

9.2 Emergency Reporting Services

9.2.1 Enhanced Emergency Number Service (E911)(Cont'd)

F. Regulations

The Company will comply with the Protocols, as set forth in, and in the form of, Service Provider E-9-1-1 Protocols, Service Provider E-9-1-1 Questionnaire and Testing Procedures in accordance with the Petition of Bell Atlantic-Pennsylvania, Inc. for a Declaratory Order (MSAG); Docket No. P-00971203; Settlement Agreement of all Parties and Joint Petition entered August 7, 1998.

The Company is indemnified under the Public Safety Emergency Telephone Act, Act 78 of 1990.

The Company's liability is fully stated in B. and C., above, and in Section 2, General Regulations.

Cases of service interruptions affecting public health and safety shall receive priority attention under any and all conditions, particularly in time of disaster. Every appropriate resource will be utilized. The Company will make reasonable best efforts to have its system fully functional as soon as possible, unless conditions beyond the Company's control prevent service restoration.

The Host Telephone Company will install the county's/municipality's MSAG in read/write format and will not modify the content of the MSAG, unless requested or permitted to do so by the county/municipality. A request to modify content by the Host Telephone Company shall be responded to by the county/municipality within ten (10) business days or the request is deemed to be approved. The request shall be in writing and shall set forth, in reasonable detail, the proposed modification and all reasons in support. The request shall be granted provided the modification is necessary for the Host Telephone Company's provision, maintenance, or upgrading of the 9-1-1 service.