

ATTACHMENT “5”
MARTINS CREEK – SIEGFRIED #2 230 kV TRANSMISSION LINE REPLACEMENT
PPL ELECTRIC MAGNETIC FIELD MANAGEMENT PROGRAM



**MAGNETIC
FIELD
MANAGEMENT**
**PPL Electric Utilities
Corporation**

DECEMBER 2004

TABLE OF CONTENTS

INTRODUCTION	1
DEVELOPMENT OF PPL EU's MAGNETIC FIELD MANAGEMENT PROGRAM.....	6
VARIABLES THAT AFFECT MAGNETIC FIELDS	6
Effect of Phase Current on Magnetic Fields	6
Effect of Conductor Configuration on Magnetic Fields	7
Effect of Distance from the Magnetic Field Source	7
SUMMARY OF PPL EU's MAGNETIC FIELD MANAGEMENT PROGRAM.....	8
MAGNETIC FIELD MANAGEMENT PROGRAM GUIDELINES	9
Overhead Lines	9
New or Rebuilt Transmission Lines	9
Reconductoring or Adding Additional Circuits to Existing Transmission Lines	14
Distribution Lines	14
Underground Transmission Lines.....	15
CHARTS.....	16

INTRODUCTION

At PPL Electric Utilities Corp. (PPL EU), magnetic field management means investigating and implementing methods at low or no cost to reduce magnetic fields in new or rebuilt transmission and distribution lines. This document explains PPL EU's Magnetic Field Management Program, which is part of PPL EU's larger Electric and Magnetic Fields (EMF) policy.

PPL EU's View

Some people are worried that electric and magnetic fields are harming their health. Others think the scientific research does not show a problem at all, and still others believe there's just too much scientific uncertainty to draw any conclusions.

Here's what we do know now. Various panels of scientists that have reviewed the EMF research generally have drawn two main conclusions. First, the large body of evidence does not demonstrate that EMF are harmful. Second, additional research is recommended to explore questions raised in some studies.

Given these conclusions, PPL EU is taking a reasoned approach in responding to the EMF issue. PPL EU's approach to the EMF issue consists of five elements:

- Providing EMF information to customers and employees
- Providing magnetic field measurements
- Establishing and implementing a magnetic field management program to reduce magnetic fields in new or rebuilt facilities when it can be done at no, or low, cost
- Integrating EMF in the public involvement process that PPL EU undertakes in the siting of transmission lines
- Have supported additional research

EMF Are All Around Us

Electric and magnetic fields occur in nature and in all living things. The earth, for instance, has a magnetic field, which makes the needle on a compass point north.

Electric fields and magnetic fields of a different type also surround every wire that carries electricity. In everyday life, these EMF arise from several basic sources, including power lines, electrical appliances, home and building wiring, other utility lines and cables, and currents flowing on water pipes. Though they often occur together, EMF are made up of two separate components:

Electric Fields

Electric fields are produced by the voltage—or electrical pressure—on a wire. The higher the voltage, the higher the electric field. As long as a wire is energized—has voltage present—an electric field is present (see Figure 1). In other words, an appliance, or an electric power line, doesn't actually have to be turned on to create an electric field. It just has to be plugged in. Electric fields diminish with distance and can be blocked or partially shielded by objects such as trees and houses.

Magnetic Fields

Magnetic fields are created by the current or flow of electricity through a wire. Generally speaking, the higher the current, the higher the magnetic field. Because they only occur when current is flowing, magnetic fields are present only when the power is turned on (see Figure 1). Magnetic fields also diminish with distance, but—unlike electric fields—are not blocked by common objects. In recent years, public and scientific interest has turned toward the magnetic field component of EMF because of some scientific studies regarding these fields.

Figure 1

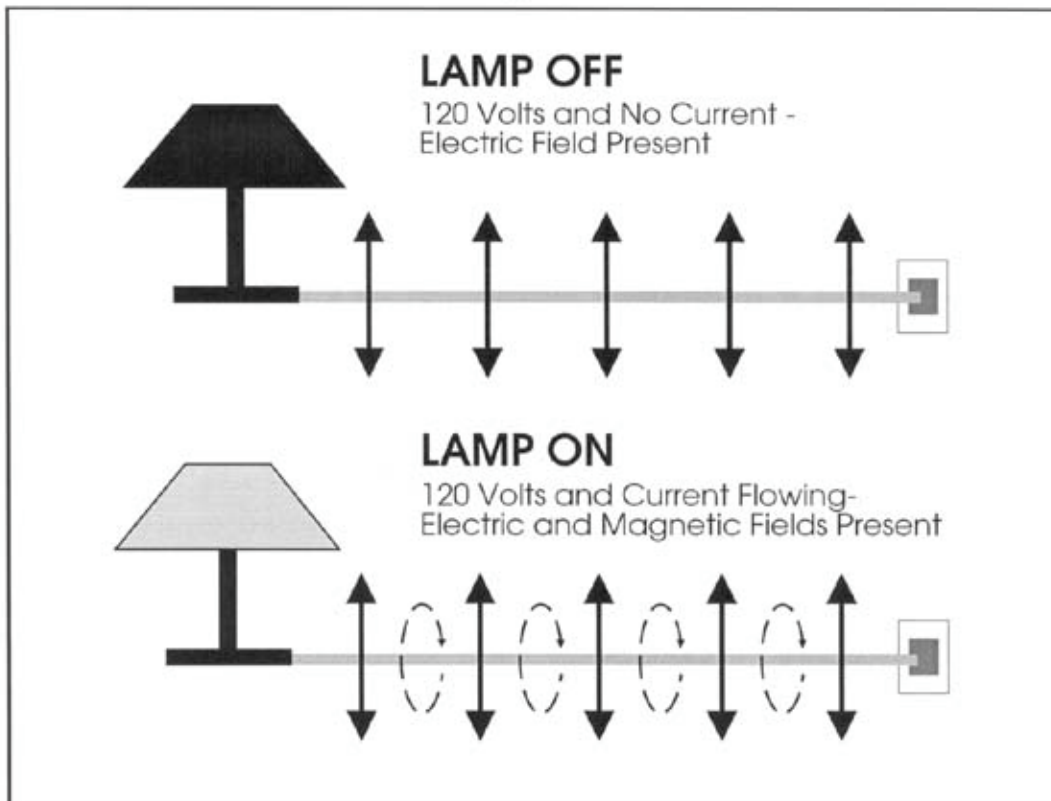

Figure 2









Magnetic field strengths decrease with distance Magnetic fields are measured in milligauss		Source: "EMF In Your Environment", U.S. Environmental Protection Agency 1992		
		At 6 inches	At 1 foot	At 2 feet
Clothes dryer		2 to 10	* to 3	*
Microwave oven		100 to 300	1 to 200	1 to 30
Toaster		5 to 20	* to 7	*
Power drill		100 to 200	20 to 40	3 to 6
Can opener		500 to 1500	40 to 300	3 to 30
Mixer		30 to 600	5 to 100	* to 10
Hair dryer		1 to 700	* to 70	* to 10
Color television		Data not available	* to 20	* to 8

FIGURE 2 * The magnetic field measurement at this distance from the operating appliance could not be distinguished from background measurements taken before the appliance had been turned on.

Measuring Magnetic Fields

Magnetic fields usually are measured in a unit called a milligauss. Magnetic field levels found in the living areas of homes typically range from less than 1 milligauss to about 4 milligauss according to the U.S. Environmental Protection Agency. They can be higher in some cases. The levels next to appliances can exceed 1,000 milligauss (1 gauss). Figures 2 and 3 show how the strength of the field falls off as you move away from the source, just as the heat of a campfire grows weaker as you walk away from it. For overhead power lines, the strength of the magnetic fields is dependent upon a number of factors that will be explained later. Those factors produce a magnetic field that drops off rapidly as you move away from the power line.

Figure 3

Sample Magnetic Field Levels in Milligauss				
Type of Overhead Power Line	Distance from the line			
	Under the line	50 ft.	100 ft.	200 ft.
220 kV and 500 kV	5-400	5-250	1-75	0.5-20
69 kV and 138 kV	3-80	0.5-2.5	0.1-10	0.1-3
12 kV and below	0.4-20	0.1-1	-	-

The magnetic field values provided in this table represent a general range of values associated with the types of overhead power lines listed and are provided for illustration. There will be circumstances in which there will be magnetic field levels above or below the range of values provided due to variations in such factors as height of the wires, current flow and so on.

DEVELOPMENT OF PPL EU's MAGNETIC FIELD MANAGEMENT PROGRAM

One element of our response to EMF concerns expressed by some of our customers is PPL EU's Magnetic Field Management Program. The program was initiated in March 1991 because PPL EU believes it makes good sense, as a matter of policy, to respond to the concerns expressed by some of our customers and to reduce magnetic fields in new and rebuilt facilities where it can be done with either no-cost or low-cost design changes.

This document updates the original program which has been revised several times since 1991. These guidelines were developed by PPL EU's EMF Working Group.

VARIABLES THAT AFFECT MAGNETIC FIELDS

Magnetic fields from transmission and distribution lines are a function of a number of design variables. The following parameters affect the magnetic field levels produced by transmission and distribution lines:

- Current
- Height of conductors above ground
- Configuration of conductors
- Distance from the line

EFFECT OF PHASE CURRENT ON MAGNETIC FIELDS

At power frequencies (i.e., 60 hertz), the magnetic field level is a function of the current or flow of electricity through a wire. Keeping all other parameters the same, the magnetic field is proportional to the current. Hence, if the current increases by 25 percent, the resulting magnetic field level will increase by 25 percent.

The overall load current on any line varies with the demand for power. It's usually highest during daytime hours and lowest at night. There also are weekly, monthly, seasonal and yearly variations.

The difference in the currents between each phase in a multiphase line also can affect the magnetic field. This difference is called phase unbalance. For a constant load, a statistical analysis of this phase unbalance can be made to determine its effect on the magnetic field. Close to the line, there is very little effect. However, the phase unbalance slows the rate at which the magnetic field decreases with distance from the line.

EFFECT OF CONDUCTOR CONFIGURATION ON MAGNETIC FIELDS

In the transmission and distribution of power, utilities like PPL EU presently use both three-phase and single-phase lines. Each phase on a three-phase power line has either a single conductor or a bundle of two or more conductors. In a three-phase system, the ground-level magnetic field is a result of the fields produced by the currents in each of the phases. Placing the three phases as close together as possible (compaction) creates some field cancellation, and the ground-level magnetic field is reduced. However, appropriate phase separation is required for the reliable operation of the line. In addition, the arrangement of the phases can create some; field cancellation and reduction of the ground-level magnetic field.

EFFECT OF DISTANCE FROM THE MAGNETIC FIELD SOURCE

Magnetic field strength diminishes with the vertical and lateral distances from the magnetic field source. Increasing the height of the conductors above ground is useful for magnetic field reduction at ground level, but may result in increased structure costs and increased aesthetic impact of the structures. Another possible method of increasing the distance to the magnetic field source is to increase the right-of-way requirements. By keeping buildings off increased rights of way, thereby requiring the public to live and work further away from lines, exposure to magnetic fields produced by the lines can be reduced. Increases in right of way are not always practical and may increase costs significantly, however.

SUMMARY OF PPL EU's MAGNETIC FIELD MANAGEMENT PROGRAM

Under its Magnetic Field Management Program, PPL EU has changed the way it builds and rebuilds some of its transmission and distribution lines. These design changes reduce magnetic field levels (assuming balanced circuit loadings and phase currents) by up to 69 percent in most of the company's new transmission lines. These guidelines now are being applied to new and reconstructed transmission facilities, based on this program.

The distribution component of the program focuses on 12 kV lines, the company's standard distribution voltage. It concentrates on the three-phase, primary 12 kV lines, since these are the most heavily loaded facilities and often are located in densely populated areas. The guidelines in this program are being applied to these three-phase, primary 12 kV lines.

A maximum 3-5 percent change in estimated cost was used as the limit for the guidelines since this value is consistent with low cost, is within estimating accuracy and is likely to have little impact on overall line costs.

The magnetic field calculations used in this document for the design of PPL EU's overall magnetic field management plan assume balanced load conditions among the phases and a fixed level of current, not necessarily representative of specific transmission or distribution lines. These levels were calculated using the Electric Power Research Institute's ENVIRO computer program. Under actual operating conditions, the magnetic field levels that result may vary due to such things as actual load per circuit, overall current on each phase conductor and the electrical configuration and operation of each line.

MAGNETIC FIELD MANAGEMENT PROGRAM GUIDELINES

The guidelines for magnetic field management are noted below, with discussion points for each.

OVERHEAD LINES

NEW OR REBUILT TRANSMISSION LINES

1. Balance transmission circuit loads and phase currents as much as possible.

- PPL EU should continue to make every effort to balance loadings between the two circuits of a double circuit line when planning new or rebuilt facilities to maximize the effects of reverse phasing.
- PPL EU should continue the practice of balancing single-phase loads across the three phases of the distribution system. (Unbalanced phase currents on the distribution system are reflected through to the transmission system.)
 - Unbalanced phase currents result in higher magnetic fields that do not drop off as quickly with distance as do the fields resulting from balanced phase currents.
 - For a 5 percent phase current unbalance, the magnetic field 50 feet from the centerline of a single circuit 138 kV line could be more than twice the value than if the same line had balanced phase circuits.
- Balanced phase currents on each three-phase distribution circuit also reduce magnetic fields from the distribution circuits themselves. In addition, they reduce magnetic fields on the transmission system from which the distribution system circuits are supplied and connected through substations.
- Apart from magnetic field considerations, balanced phase currents on each three-phase distribution circuit also reduce line losses and improve the system voltage.

2. Continue with the present practice of using long-span construction as the PPL EU 138/69 kV standard

- Structure designs for short-span and long-span construction are illustrated on Charts I and II, respectively.
 - Short-span design does not significantly reduce magnetic fields when compared to long-span design even though it is more compact than long-span design. Comparison of the magnetic field values from Chart III indicates essentially the same values. Therefore, short-span design should not be used solely to reduce magnetic fields.
 - PPL EU will continue to use long-span construction for 138/69 kV double-circuit lines and for single-circuit/future-double-circuit lines.
 - For single-circuit/future-double-circuit lines, PPL EU will continue to install two conductors on the top positions and one in the middle position as shown in Chart IV.
 - This arrangement minimizes magnetic fields as shown in Chart V by placing the three initial conductors higher on the structure, which increases the ground clearances, and by placing the conductors in a triangular configuration.

3. Compact design structures are not a low-cost alternative and should be used for magnetic field reduction only in special applications.

Chart VI illustrates the compact design structure.

- The compact design increases the initial installation costs by 79 percent when compared to the long-span design but reduces the magnetic field from 9 mG to 3 mG (about 67 percent) at the edge of the 100-foot-wide right of way as shown on Chart III.

4. Reverse phase new or rebuilt double-circuit transmission lines for all voltage levels.

- Reverse phasing was adopted by PPL EU in March 1991 for double-circuit 138/69 kV transmission lines and in April 1992 for all other double circuit transmission lines. Reverse phasing is shown in Chart VII. Reverse phasing will reduce the magnetic fields when the current flow on both circuits is in the same

direction. Calculated values contained here are based on balanced and equal phase currents on both circuits.

- Reverse phasing reduces the magnetic field of a double circuit 138 kV single pole transmission line from 29 mG to 9 mG (about 69 percent) at the edge of the 100-foot-wide right of way as shown on Chart III.
- Reverse phasing reduces the magnetic field of a double circuit 230 kV single pole transmission line from 49 mG to 16 mG (about 67 percent) at the edge of the 150-foot-wide right of way as shown on Chart VIII.
- Reverse phasing reduces the magnetic field of a double-circuit 500 kV single pole transmission line from 37 mG to 21 mG (about 43 percent) at the edge of the 200-foot-wide right of way as shown on Chart IX.
- When new or rebuilt double-circuit lines require tapping existing double-circuit lines, PPL EU will review the existing lines to determine if reverse phasing can be provided at low cost.
- Computer modeling is required to develop the optimum phasing and overall conductor arrangements for lines added to, or rebuilt in, multiple-line corridors.
 - Merely adding a reverse-phase double-circuit line to an existing transmission line corridor or reverse phasing a rebuilt line in the multiple-line corridor will not necessarily produce lower magnetic field levels at the edge of the corridor right of way.
 - The corridor must be computer modeled with all the lines, existing phase conductor locations and currents. Then, magnetic field calculations must be made varying the phase arrangements of the new or reconstructed line to determine the appropriate phasing arrangement.
 - Current flow direction on a line also must be considered. For example, a reverse-phased line should have the current flowing in the same direction on both circuits. If the current flow is in the opposite direction for one circuit, reverse phasing will not produce the lowest magnetic field and another phase arrangement that produces lower fields may need to be utilized.

5. Increase the minimum ground clearance for all new transmission lines.

138/69 kV Transmission Lines

- Increasing the minimum line design ground clearance from 25 feet to 30 feet may add up to about 5 percent to the installed cost of a new double-circuit single pole 138/69 kV line. For a given project, such cost may be substantially less, however. In fact, PPL EU frequently uses higher-than-minimum ground clearances due to such features as road crossings, line crossings and site-specific terrain. With long-span reverse-phase design, the magnetic field is reduced from 9 mG to 7 mG (about 22 percent) at the edge of a 100-foot-wide right of way as shown in Chart X.
 - In the actual design of transmission lines to include higher minimum ground clearances, there may be limited segments (such as highway crossings, severe slopes and transmission line crossing locations) where National Electrical Safety Code (NESC) minimum ground clearances may need to be used. The NESC minimum ground clearances are less than the increased ground clearance discussed previously.

230 kV Transmission Lines

- Increasing the minimum line design ground clearances from 27 feet to 32 feet may add up to about 5 percent to the cost of a single-circuit single-pole line (current standard). For a given project, such cost may be substantially less, however. In fact, PPL EU frequently uses higher-than-minimum ground clearances due to such features as road crossings, line crossings and site-specific terrain. By increasing the clearances, the magnetic field is reduced from 30 mG to 28 mG (about 7 percent) at the edge of a 150-foot-wide right of way.
- Increasing clearances from 27 feet to 32 feet could theoretically add up to about 2.8 percent to the cost of a double-circuit single-pole line (current standard) and reduce the magnetic field of a reverse-phase line from 16 mG to 15 mG (about 6 percent) at the edge of a 150-foot-wide right of way. Chart XI is a summary of this data.
- Studies are required for each new 230 kV line to determine optimum structure types, ground clearances, configurations and designs to reduce field levels. Such

studies could include analysis of reduction measures such as additional minimum ground clearances, increasing conductor tensions, using reduced phase spacing (a "Delta" configuration on a single-circuit line), installing the second circuit initially, and/or adding a second set of conductors that are reverse phased and operated in parallel with the first set (bundled/split phase).

500 kV Transmission Lines

- Increasing ground clearances from 33 feet to 53 feet may add up to about 4.5 percent to the cost of a single-circuit "H-frame" line (current standard). For a given project, such cost may be substantially less, however. In fact, PPL EU frequently uses higher-than-minimum ground clearances due to such features as road crossings, line crossings and site-specific terrain. By increasing the clearances, the magnetic field is reduced from 42 mG to 35 mG (about 17 percent) at the edge of a 200-foot-wide right of way.
- Increasing ground clearances from 33 feet to 53 feet could theoretically add up to 2.8 percent to the cost of a double-circuit "H-frame" line (current standard) and reduces the magnetic field of a reverse-phase line from 21 mG to 16 mG (about 24 percent) at the edge of a 200-foot-wide right of way. Chart XII is a summary of this data.
- Studies are required for each new 500 kV line to determine optimum structure types, ground clearances, configurations and designs to reduce field levels. Such studies could include analysis of reduction measures such as additional minimum ground clearances, increasing conductor tensions, using reduced-phase spacing (a "Delta" configuration on a single circuit line), installing the second circuit initially, and/or adding a second set of conductors that are reverse phased and operated in parallel with the first set (bundled/split phase).

RECONDUCTORING OR ADDING ADDITIONAL CIRCUITS TO EXISTING TRANSMISSION LINES

When reconductoring or adding additional circuits to existing transmission lines, PPL EU will evaluate low-cost or no-cost options for magnetic field management on a case-by-case basis.

When reconductoring existing transmission lines or adding additional circuits, low-cost alternatives may not exist; however, the following steps will be taken:

- For a single-circuit line, the use of a Delta arrangement or other modifications on the existing structure, with reduced-phase spacing, will be evaluated.
- For double-circuit lines, application of reverse phasing may reduce the magnetic field under the line and within the right of way and will be evaluated.
- For single- and double-circuit lines, evaluate using higher conductor tensions that can increase the minimum line design ground clearance.

DISTRIBUTION LINES

At the 12 kV distribution level, new main three-phase lines will continue to be constructed with five feet of additional ground clearance.

- Main lines are the most heavily loaded sections of a distribution line and therefore have the highest magnetic fields associated with them.
- Increasing the ground clearance by five feet reduces the magnetic field under the line from 14 mG to 11 mG using the standard eight-foot crossarm design. These values are based on increasing pole heights from 45 feet to 50 feet and a typical operating current of 300 amps per phase.
- Chart XIII is a summary of this data. Increasing ground clearance by five feet could theoretically add about 5 percent to the cost of a typical distribution line.

UNDERGROUND TRANSMISSION LINES

Underground transmission lines are required due to environmental or land use factors or restrictions on available clearances, PPL EU will evaluate options for magnetic field management techniques on a case-by-case basis.

- The phase arrangement that produces the lowest field will be determined.
- The depth of burial of the line will be determined considering the cost of excavation and the location of other buried utilities in the area.
- The use of steel pipe ferromagnetic shielding that reduces magnetic fields will be evaluated.

Short-Span Construction

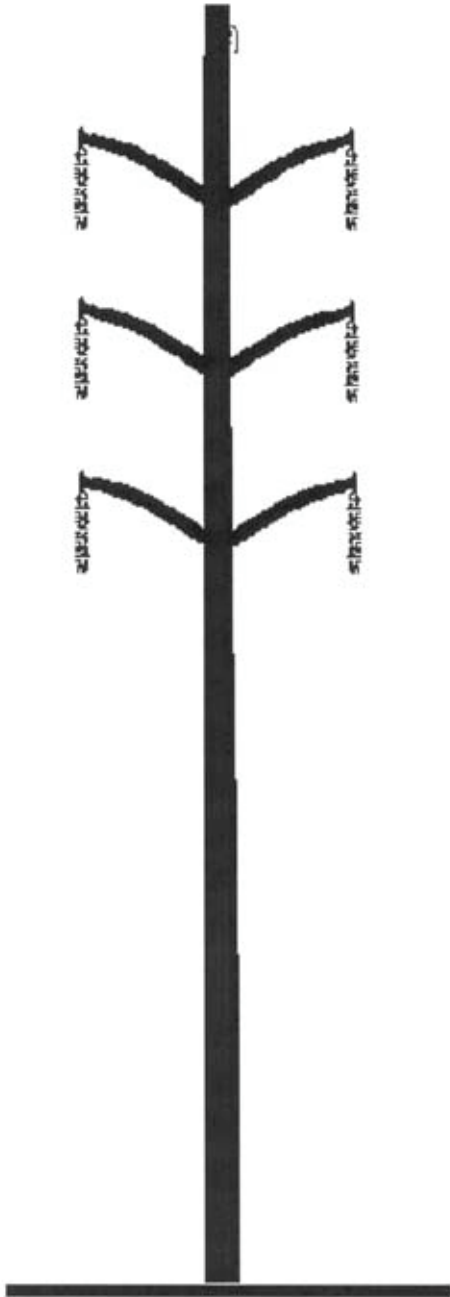

- **More compact design**
- **Should not be used solely to reduce magnetic fields**
- **Typical conductor data:**
 - 1 3/8" HS steel overhead ground wire - 7.3 feet sag
 - 6-556.5 KCMIL 24/7 ACSR power conductors - (PARAKEET) 10.0 feet sag
 - Average span - 400 feet

Long-Span Construction Remains PPL EU 138 kV Standard



- Lower cost alternative
- Reduces magnetic fields due to higher structures
- Typical conductor data:
 - 1 3/8" HS steel overhead ground wire - 17.3 feet sag
 - 6-556.5 KCMIL 24/7 ACSR power conductors - (PARAKEET) 23.0 feet sag
 - Average span - 600 feet

**138/69 kV REVERSE-PHASE TRANSMISSION LINES
CALCULATED MAGNETIC FIELDS AT 400 AMPERES**

TYPE CONSTRUCTION	MAGNETIC FIELD IN MILLIGAUSS AT THE EDGE OF THE RIGHT OF WAY
SHORT SPAN (CHART I)	30
SHORT SPAN (REVERSE PHASE)	8
LONG SPAN (CHART II)	29
LONG SPAN (REVERSE PHASE)	9
COMPACT (CHART VI)	14
COMPACT (REVERSE PHASE)	3

The edge of right of way is 50 feet from the line centerline.
 The 400 ampere phase current is balanced between phases.
 Calculations are based on a minimum ground clearance of 25 feet.
 LONG SPAN, SHORT SPAN and COMPACT are double-circuit lines.

Typical Single-Circuit Structure Designs

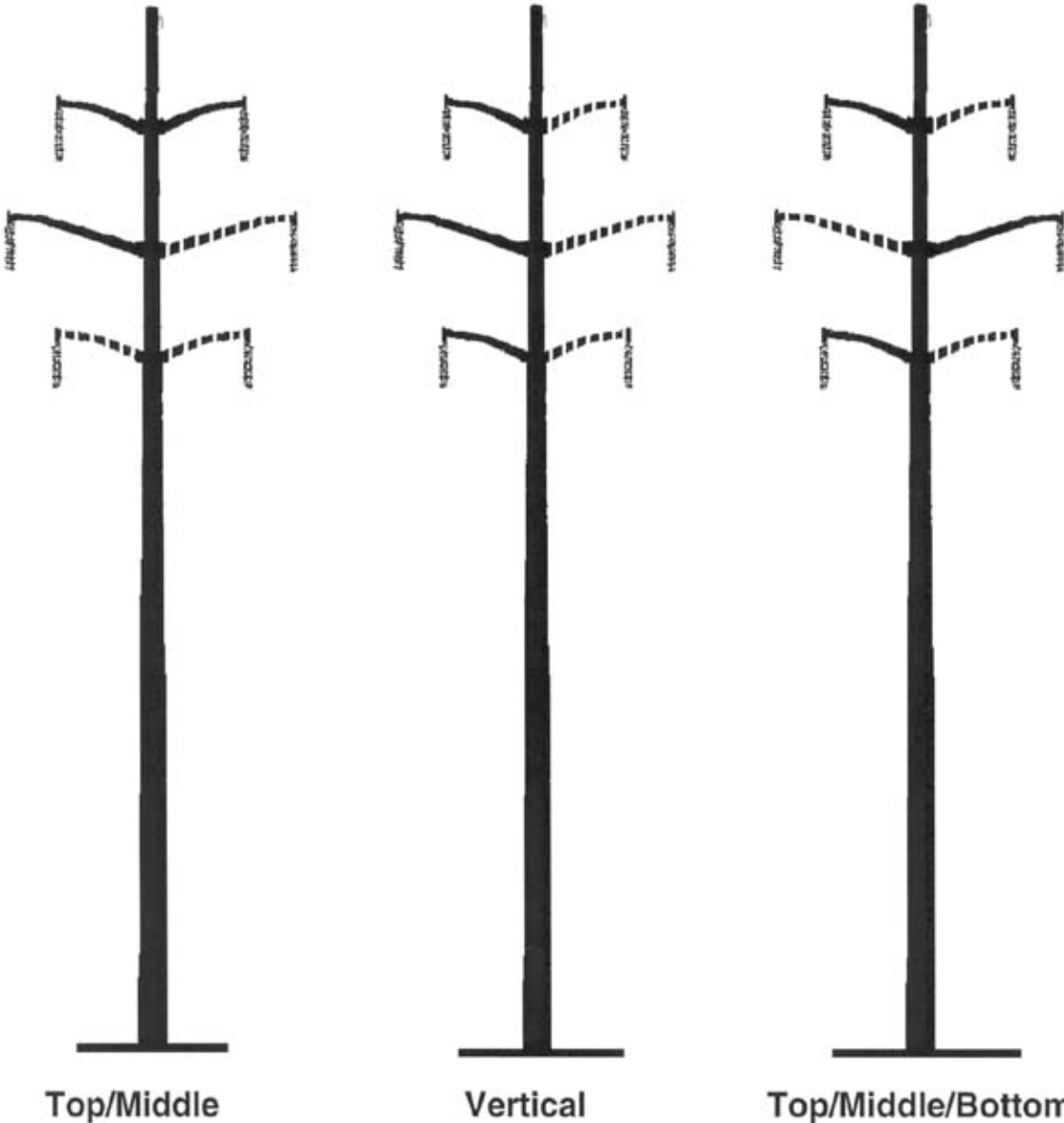

—— initial single circuit
- - - - future second circuit

**138/69 kV SINGLE CIRCUIT TRANSMISSION LINES
CALCULATED MAGNETIC FIELDS AT 400 AMPERES**

TYPE CONSTRUCTION	MAGNETIC FIELD IN MILLIGAUSS AT THE EDGE OF THE RIGHT OF WAY
TOP/MIDDLE/BOTTOM	20
VERTICAL	17
TOP/MIDDLE	12

The edge of right of way is 50 feet from the line centerline.
The 400 ampere phase current is balanced between phases.
Calculations are based on a minimum ground clearance of 25 feet.

Compact Design Structure

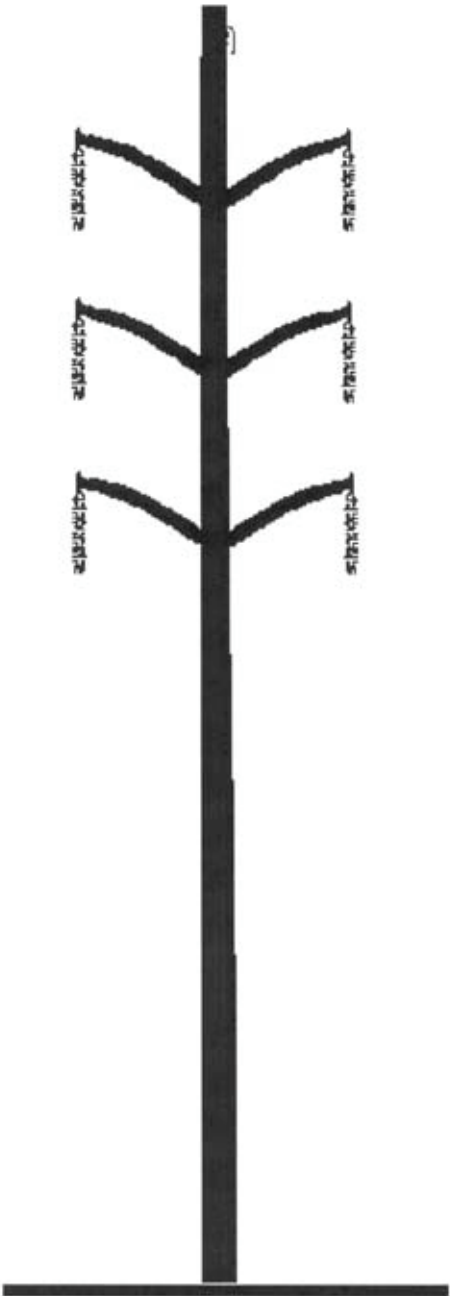

- Minimize magnetic fields due to compact design
- Not a low-cost alternative
- Typical conductor data:
 - 1 3/8" HS steel overhead ground wire - 9.0 feet sag
 - 6-556.5 KCMIL 24/7 ACSR power conductors - (PARAKEET) 9.0 feet sag
 - Average span - 300 feet

Reverse Phasing of Double-Circuit Transmission Lines

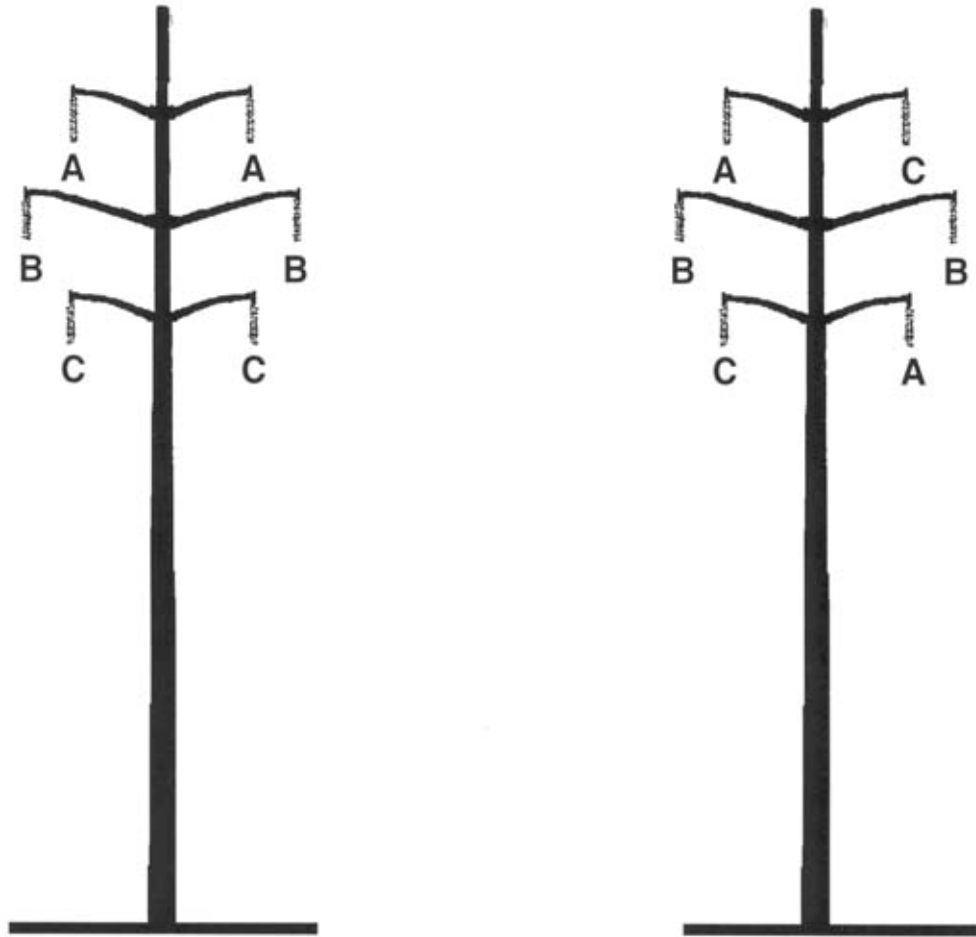

From: → → → → To:

Reverse phasing also can be one of the following phase arrangements:

A	B		B	A		B	C		C	A		C	B
C	C	or	C	C	or	A	A	or	B	B	or	A	A
B	A		A	B		C	B		A	C		B	C

**230 kV REVERSE-PHASE TRANSMISSION LINES
CALCULATED MAGNETIC FIELDS AT 800 AMPERES**

TYPE CONSTRUCTION	MAGNETIC FIELD IN MILLIGAUSS AT THE EDGE OF THE RIGHT OF WAY
DOUBLE CIRCUIT POLE	49
DOUBLE CIRCUIT POLE (REVERSE-PHASE)	16

The edge of right of way is 75 feet from the line centerline.
The 800 ampere phase current is balanced between phases.
Calculations are based on a minimum ground clearance of 27 feet.

**500 kV REVERSE-PHASE TRANSMISSION LINES
CALCULATED MAGNETIC FIELDS AT 1100 AMPERES**

TYPE CONSTRUCTION	MAGNETIC FIELD IN MILLIGAUSS AT THE EDGE OF THE RIGHT OF WAY
DOUBLE CIRCUIT POLE	37
DOUBLE CIRCUIT POLE (REVERSE PHASE)	21

The edge of right of way is 100 feet from the line centerline.
The 1,100 ampere phase current is balanced between phases.
Calculations are based on a minimum ground clearance of 33 feet.

**INCREASED 138/69 kV MINIMUM GROUND CLEARANCE
CALCULATED MAGNETIC FIELDS AT 400 AMPERES**

TYPE CONSTRUCTION	MINIMUM GROUND CLEARANCE FEET	MAGNETIC FIELD IN MILLIGAUSS AT THE EDGE OF THE RIGHT OF WAY
SINGLE CIRCUIT TOP/MIDDLE	25	12
SINGLE CIRCUIT TOP/MIDDLE	30	10
LONG SPAN	25	29
LONG SPAN	30	26
LONG SPAN (REVERSE PHASE)	25	9
LONG SPAN (REVERSE PHASE)	30	7

The edge of right of way is 50 feet from the line centerline.
The 400 ampere phase current is balanced between phases.

**INCREASED 230 kV MINIMUM GROUND CLEARANCE
CALCULATED MAGNETIC FIELDS AT 800 AMPERES**

TYPE CONSTRUCTION	MINIMUM GROUND CLEARANCE FEET	MAGNETIC FIELD IN MILLIGAUSS AT THE EDGE OF THE RIGHT OF WAY
SINGLE CIRCUIT TOP/MIDDLE	27	30
SINGLE CIRCUIT TOP/MIDDLE	32	28
DOUBLE CIRCUIT POLE	27	49
DOUBLE CIRCUIT POLE	32	46
DOUBLE CIRCUIT POLE (REVERSE PHASE)	27	16
DOUBLE CIRCUIT POLE (REVERSE PHASE)	32	15

The edge of right of way is 75 feet from the line centerline.
The 800 ampere phase current is balanced between phases.

**INCREASED 500 kV MINIMUM GROUND CLEARANCE
CALCULATED MAGNETIC FIELDS AT 1,100 AMPERES**

TYPE CONSTRUCTION	MINIMUM GROUND CLEARANCE FEET	MAGNETIC FIELD IN MILLIGAUSS AT THE EDGE OF THE RIGHT OF WAY
SINGLE CIRCUIT "H" STRUCTURE	33	42
SINGLE CIRCUIT "H" STRUCTURE	53	35
DOUBLE CIRCUIT POLE	33	37
DOUBLE CIRCUIT POLE	53	31
DOUBLE CIRCUIT POLE (REVERSE PHASE)	33	21
DOUBLE CIRCUIT POLE (REVERSE PHASE)	53	16

The edge of right of way is 100 feet from the line centerline.
The 1,100 ampere phase current is balanced between phases.

**12 kV DISTRIBUTION LINES
CALCULATED MAGNETIC FIELDS AT 300 AMPERES**

TYPE CONSTRUCTION	POLE HEIGHT FEET	MAGNETIC FIELD IN MILLIGAUSS*	
		AT CENTERLINE	AT 30 FEET FROM CENTERLINE
STANDARD CROSSARM	45	14	7
STANDARD CROSSARM	50	11	6

* Field level under the line at mid-span based on 300 amps, balanced loading, one meter above ground level.