



17 North Second Street
12th Floor
Harrisburg, PA 17101-1601
717-731-1970 Main
717-731-1985 Fax
www.postschell.com

Jessica R. Rogers

jrogers@postschell.com
717-612-6018 Direct
717-731-1985 Fax
File #: 2507/148685

October 11, 2011

Rosemary Chiavetta
Secretary
Pennsylvania Public Utility Commission
Commonwealth Keystone Building
400 North Street, 2nd Floor North
P.O. Box 3265
Harrisburg, PA 17105-3265

RE: Application Of PPL Electric Utilities Corporation Under 15 Pa. C.S. §1511(c) For A Finding And Determination That The Service To Be Furnished By The Applicant Through Its Proposed Exercise Of The Power Of Eminent Domain To Acquire A Right-Of-Way And Easement Over And Across The Lands Of Ronald and Dianne Mace In Lower Mahanoy Township, Northumberland County, Pennsylvania For The Proposed Richfield-Dalmatia 69 kV Transmission Tie Line Is Necessary Or Proper For The Service, Accommodation, Convenience Or Safety Of The Public Docket No. A-2011-

Dear Secretary Chiavetta:

Enclosed for filing are the original and three (3) copies of the Application of PPL Electric Utilities Corporation along with the exhibits and appendices in support of the Application in the above-referenced proceeding.

As indicated on the certificate of service, copies are being provided to the parties in the manner indicated.

Respectfully Submitted,

Jessica R. Rogers

JRR/skr

Enclosures

cc: Certificate of Service

CERTIFICATE OF SERVICE

I hereby certify that a true and correct copy of the foregoing has been served upon the following persons, in the manner indicated, in accordance with the requirements of 52 Pa. Code § 1.54 (relating to service by a participant).

VIA CERTIFIED MAIL RETURN RECEIPT REQUESTED

Ronald Mace & Dianne Mace
584 Malta Road
Dalamatia, PA 17017

Date: October 11, 2011

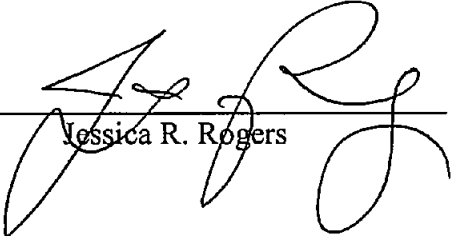

Jessica R. Rogers

**BEFORE THE
PENNSYLVANIA PUBLIC UTILITY COMMISSION**

Application Of PPL Electric Utilities :
Corporation Under 15 Pa. C.S. §1511(c) For A :
Finding And Determination That The Service :
To Be Furnished By The Applicant Through :
Its Proposed Exercise Of The Power Of :
Eminent Domain To Acquire A Right-Of-Way :
And Easement Over And Across The Lands Of : Docket No. A-2011-_____

Ronald and Dianne Mace In Lower Mahanoy :
Township, Northumberland County, :
Pennsylvania For The Proposed Richfield- :
Dalmatia 69 kV Transmission Tie Line Is :
Necessary Or Proper For The Service, :
Accommodation, Convenience Or Safety Of :
The Public :

**APPLICATION OF
PPL ELECTRIC UTILITIES CORPORATION
TO EXERCISE THE POWER OF EMINENT DOMAIN
TO ACQUIRE A RIGHT-OF WAY AND EASEMENT
ACROSS THE PROPERTY OF RONALD AND DIANNE MACE**

TO THE PENNSYLVANIA PUBLIC UTILITY COMMISSION:

I. INTRODUCTION AND OVERVIEW

1. This Application is filed by PPL Electric Utilities Corporation (“PPL Electric”).
2. PPL Electric’s principal address is:

Two North Ninth Street
Allentown, Pennsylvania 18101
3. PPL Electric is a “public utility” and an “electric distribution company” as defined in Sections 102 and 2803 of the Pennsylvania Public Utility Code, 66 Pa. C.S. §§ 102, 2803. PPL Electric is also a “public utility corporation” as defined in Section 1103 of the Business Corporation Law of 1988, 15 Pa.C.S. § 1103.

4. PPL Electric provides electric distribution, transmission and provider of last resort services subject to the regulatory jurisdiction of the Pennsylvania Public Utility Commission (“Commission”) to approximately 1.4 million customers throughout its certificated service territory, which includes all or portions of twenty-nine counties and encompasses approximately 10,000 square miles in eastern and central Pennsylvania.

5. PPL Electric owns approximately 5,000 miles of transmission lines operating at 69,000 volts or higher, approximately 330 substations with a capacity of 10,000 KVA¹ or more, and approximately 43,000 miles of distribution lines operating at less than 69,000 volts.

6. PPL Electric is a corporation organized and existing under the laws of the Commonwealth of Pennsylvania. It was duly formed by consolidation and merger, having received Letters Patent dated June 4, 1920, from the Governor of the Commonwealth of Pennsylvania. PPL Electric is now subject to the Pennsylvania Business Corporation Law of 1988, P.L. 1444, No. 177, Section 103, *as amended*, 15 Pa.C.S. §§ 1101 *et seq.* PPL Electric submits this Application pursuant to Section 1511 of the Business Corporation Law of 1988, 15 Pa.C.S. § 1511.

7. PPL Electric’s attorneys are:

David B. MacGregor (Pa. Bar I.D. #28804)
Post & Schell, P.C.
Four Penn Center
1600 John F. Kennedy Boulevard
Philadelphia, PA 19103-2808
Voice: 215.587.1197
Fax: 215.320.4879
E-mail: dmacgregor@postschell.com

John H. Isom (Pa. Bar I.D. #16569)
Jessica R. Rogers (I.D. #309842)
Post & Schell, P.C.
17 North Second Street

¹ Kilo volt-amperes.

12th Floor
Harrisburg, PA 17101-1601
Voice: 717.612.6000
Fax: 717.731.1985
E-mail: jisom@postschell.com
E-mail: jrogers@postschell.com

Paul E. Russell (Pa. Bar I.D. #21643)
Associate General Counsel
PPL Services Corporation
Two North Ninth Street
Allentown, PA 18101
Voice: 610.774.4254
Fax: 610.774.6726
E-mail: perussell@pplweb.com

PPL Electric's attorneys are authorized to receive all notices and communications regarding this Application.

8. This Application includes the accompanying, separately-bound Attachments 1-10. Attachment 1 to this Application includes a map of PPL Electric's transmission system showing substations and transmission lines. PPL Electric's transmission system is operated as part of the PJM Interconnection LLC ("PJM"), which has been approved by the Federal Energy Regulatory Commission ("FERC") as the Regional Transmission Organization ("RTO") of the transmission systems of electric utilities in the region that includes PPL Electric's service territory.

9. PPL Electric is proposing to construct a new 69 kV transmission Tie Line to be known as the Richfield-Dalmatia 69 kV Tie Line and the new Meiserville 69-12 kV Substation.

a. The Tie Line will connect the existing Juniata-Richfield 69 kV line with the existing Sunbury-Dauphin 69 kV line. The proposed Richfield-Dalmatia Tie Line will be an 11.54 mile long double circuit 69 kV line. Initially, only one circuit will be installed. A second circuit will be added when future load growth makes it appropriate to do so. The proposed line will extend through portions of Snyder, Juniata, and Northumberland Counties.

b. The new Meiserville 69-12 kV Substation will be located in Susquehanna Township, Juniata County. It will be connected to and supplied by the proposed Richfield-Dalmatia Tie Line. The new substation will supply two new 12 kV distribution lines to serve customer load in the area. PPL Electric has applied for the rights to condemn the property upon which the Substation will be located in a concurrently filed application.

10. The purpose of the Richfield–Dalmatia Tie Line and the Meiserville 69-12 kV Substation is to resolve violations of reliability standards set forth in PPL Electric’s Reliability Principles and Practices (“RP&P”) applicable to 69 kV transmission lines and 12 kV distribution lines.

II. DESCRIPTION OF THE PROJECT

11. PPL Electric proposes to construct a new 69 kV transmission Tie Line to connect the existing Juniata–Richfield 69 kV line to the existing Sunbury–Dauphin 69 kV line. The new transmission line will provide power to the planned Meiserville 69-12 kV Substation, which will be located in Susquehanna Township, Juniata County. It will also provide a backup source of supply to the Juniata–Richfield and Sunbury–Dauphin 69kV transmission lines for speedy and orderly load restoration in the event of single circuit transmission line outages.

12. Attachment 1 to this Application contains functional one-line diagrams of the existing and proposed transmission facilities in the area. In addition, Attachment 1 contains functional one-line diagrams of the existing and proposed 12 kV distribution system in the area. These diagrams include the Richfield-Dalmatia 69 kV Tie Line, the Meiserville 69-12 kV Substation and the 12 kV distribution lines it will supply.

13. The Richfield–Dalmatia Tie Line will be designed and constructed for two circuits, however, only one circuit will be installed initially. A second circuit will be added

when future load growth makes it appropriate to do so. The entire line will be designed and constructed to operate at 69 kV.

14. The estimated cost to construct the Richfield–Dalmatia 69 kV transmission Tie Line and Meiserville 69-12 kV substation is approximately \$12 million. Construction is scheduled to begin in November of 2011 to meet the required in-service date of November 30, 2012.

15. In order to construct the Richfield-Dalmatia 69 kV Tie Line, PPL Electric needs rights-of-way and easements from 54 landowners, including Norfolk Southern Corporation. To date, PPL Electric has successfully obtained appropriate rights-of-way and easements from 43 landowners through voluntary transactions and is working with Norfolk Southern Corporation to obtain the necessary easements. This Application is one of 10 that PPL Electric is filing with the Commission regarding the Richfield-Dalmatia 69 kV Tie Line.

III. NEED FOR THE RICHFIELD-DALMATIA TIE LINE AND MEISERVILLE 69-12 KV SUBSTATION

16. The Richfield–Dalmatia Tie Line and the Meiserville 69-12 kV substation are needed to improve reliability on both the distribution and transmission systems in order for PPL Electric to meet the reliability standards set forth in its RP&P manual.

17. PPL Electric utilizes System Planning in order to assure that its transmission and distribution systems can supply electricity to all customer load in a way that is reliable, economic and environmentally acceptable. PPL Electric's transmission and distribution systems are planned and constructed so that they can sustain probable contingencies and disturbances with minimal customer service interruption, and so that they can adequately serve each customer's needs with regard to capacity, voltage and reliability. PPL Electric plans its systems so that normal operation will not load any electric facility beyond its normal continuous rating, and so

that the loss of any single transmission line, generating unit, power transformer, substation bus, circuit breaker, or double circuit line does not cause any of its electric facilities to operate beyond their applicable thermal ratings. PPL Electric incorporated these and numerous other requirements relating to safe and effective operating practices in the PPL Electric RP&P manual.

18. Presently, PPL Electric's distribution and transmission systems in the area of the proposed Richfield-Dalmatia 69 kV Tie Line violate certain guidelines that are set forth in the RP&P.

19. A 12 kV distribution line that services a portion of the area in which the Richfield-Dalmatia Tie Line will be constructed is the Dalmatia 36-02 line. As explained below, that line violates several guidelines of PPL Electric's RP&P, and it has been among the worst performing lines on PPL Electric's system.

20. PPL Electric's RP&P guidelines provide that no more than 1,300 customers should be served from a 12 kV circuit, and that a 12 kV circuit should not supply more than 50 circuit miles of distribution lines. The Dalmatia 36-02 12 kV distribution line currently exceeds PPL Electric's RP&P guidelines. The 12 kV line currently serves more than 2,200 customers and supplies 194 circuit miles of distribution lines.

21. The Dalmatia 36-02 12 kV distribution line supplies a substantial area. It is supplied from the Dalmatia Substation, in Lower Mahanoy Township, Northumberland County on the east side of the Susquehanna River. It crosses the river and stretches 194 circuit miles across portions of seven townships and a borough in Northumberland, Snyder, and Juniata Counties.

22. The rural nature of the area, the presence of numerous trees and length of the circuit all increase its exposure to hazards. These hazards have resulted in a large number of outages each year.

23. The existing facilities in the area also violate certain reliability standards in PPL Electric's RP&P for 69 kV transmission lines. The RP&P provides that an outage of a single circuit 69 kV transmission line may interrupt 60 MW of load for up to two hours. After two hours, 30 MW of load must be restored, leaving only 30 MW of load interrupted. In order to comply with the RP&P, load must be restored by field switching 30 MW of load to adjacent transmission lines. If there were an outage on the Juniata-Richfield line under 2012 summer peak load conditions, approximately 44 MW of load would remain interrupted after all field switching moves had been completed to transfer load to the adjacent lines. If the same type of outage were to occur on the Sunbury-Dauphin 69 kV transmission line under 2012 peak summer load conditions, 33 MW of load would remain interrupted after all field switching moves had been completed. With the current facilities, in the event of an outage of either of these two lines under summer peak load conditions, it would not be possible to switch sufficient loads to other lines in order to meet the RP&P standards explained above.

24. After identifying these violations, PPL Electric examined various functional alternatives to resolve them. After extensive analysis, PPL Electric concluded that the preferred functional alternative was to construct an 11.54 mile, 69 kV transmission line between the existing PPL Electric Juniata-Richfield 69 kV line in West Perry Township, Snyder County, and the Sunbury-Dauphin 69 kV line in Lower Mahanoy Township, Northumberland County.

25. The proposed Tie Line will improve the integrity of the system and resolve all of the RP&P 69 kV transmission violations in the area by providing additional transmission

capacity and load transfer capability. As a result of the increased transmission capacity and load transfer capability, PPL Electric will be able to restore all load on the Juniata–Richfield Line and Sunbury–Dauphin Line to meet the RP&P load drop standards for a single 69 kV transmission line outage. In addition, the new Tie Line will supply the proposed Meiserville 69-12 kV Substation.

26. The Richfield–Dalmatia Tie Line will allow PPL Electric to provide reliable service to its customers, and bring the Juniata-Richfield 69 kV line and the Sunbury–Dauphin 69 kV line in compliance with PPL Electric’s RP&P.

27. The Meiserville 69-12 kV Substation will resolve the RP&P distribution system guideline violations for customer count per feeder and circuit line miles that are explained above. The existing Dalmatia 36-02 12 kV distribution line will be segmented into three separate lines, and two of the lines will be connected to and under normal operating conditions will be supplied from the Meiserville 69-12 kV Substation. The segmentation of the Dalmatia 36-02 12 kV distribution line into three lines will reduce the number of customers served by the Dalmatia 36-02 12 kV distribution line and shorten it to meet RP&P reliability criteria. The new substation, together with the two new 12 kV distribution lines it will supply, will therefore improve the reliability of the existing 12 kV distribution system in the area. In addition, the substation will be located central to the load that it will service, which will provide reliability and operating flexibility.

28. The Meiserville 69-12 kV Substation will bring the distribution facilities, most specifically the Dalmatia 36-02 12 kV distribution line into compliance with PPL Electric’s RP&P. In addition, the distribution facilities in the area will be able to serve significant growth in the area without the need for substantial new facilities.

IV. SITING ANALYSIS

29. Although the siting and construction of the proposed project do not require Commission approval, PPL Electric used the Commission's regulations at 52 Pa. Code § 57.72(c) for guidance in the siting process. In doing so, PPL Electric has selected an appropriate and reasonable route for the Richfield-Dalmatia 69 kV Tie Line.

30. PPL Electric conducted an extensive, multi-faceted analysis to determine the route for the Richfield-Dalmatia 69 kV Tie Line. This analysis included designation of a "Study Area," compilation of an environmental inventory, identification of alternative routes, analysis of the alternative routes and selection of the proposed line route. This process enabled PPL Electric to select a route for the proposed transmission line that appropriately balances functional requirements, environmental factors, social factors and cost considerations.

31. The Study Area for the project is shown in Attachment 2. The Study Area is the general area in which alternative line routes can be feasibly sited to meet the Project's functional requirements and minimize social impacts, environmental impacts, and project costs. For the Richfield-Dalmatia 69 kV Tie Line, the Study Area was between 4.9 and 4.2 miles from north to south, and nearly 12 miles from east to west, for a total of 64.2 square miles. The Study Area included portions of Monroe Township and Susquehanna Township in Juniata County, Chapman Township, Perry Township, and West Perry Township, in Snyder County, and Lower Mahanoy Township, in Northumberland County.

32. The next step in the route selection process was the identification of routing constraints. In order to identify constraints, PPL Electric compiled a detailed environmental inventory of the Study Area. Using that inventory, PPL Electric began the identification of potential routes.

33. First, large constraints were identified and possible routes to avoid them to the extent practical were identified. These routes were then adjusted to avoid small constraints to the extent practical. Although complete avoidance of all constraints is not feasible, PPL Electric sought routes that would minimize intrusions into constrained areas.

34. The project was then reviewed with the appropriate municipal and state officials and agencies, as well as the public through public meetings in order to develop a “constraint” map depicting areas that should be avoided, if practical.

35. PPL Electric identified numerous constraints in determining potential routes. The congested nature of the area around Dalmatia limited routing options to the less congested areas to the north and south of Dalmatia. A residential development along the west bank of the Susquehanna River limited the routes available for crossing the river. Finally, the routes were sited to the north and south of State Game Lands #194, in an effort to avoid the public lands. After receiving governmental and public input, three alternatives were selected.

36. PPL Electric considered three alternative routes for this line. These routes are:

- Alternative 1, which would involve the construction of 11.54 miles of new 69 kV line that would extend from PPL Electric’s Juniata–Richfield 69 kV line in West Perry Township, Snyder County, and run in a southeasterly direction to the Sunbury–Dauphin 69 kV line in Lower Mahanoy Township, Northumberland County. This line would run through Snyder, Juniata, and Northumberland Counties. Alternative 1 would require a 150 foot right-of-way at the proposed Susquehanna River crossing and a new 100 foot right-of-way for the remainder of the line.
- Alternative 2, which would involve the construction of 12.49 miles of new 69 kV line that would extend from PPL Electric’s Juniata–Richfield 69 kV line in West Perry Township, Snyder County and would proceed in an east/southeasterly direction to connect with the existing Sunbury–Dauphin 69 kV line in Lower Mahanoy Township, Northumberland County. Alternative 2 would require a new 100 foot right-of-way, and has approximately 2.5 miles in common with Alternative 1.
- Alternative 3, which would involve the construction of 12.07 miles of new 69 kV line from the Juniata–Richfield 69 kV line in Monroe Township, and would proceed in a southeasterly direction to its connection point with the existing Sunbury–Dauphin 69 kV line in Lower Mahanoy Township. This alternative would require a 150 foot

right-of-way at the proposed Susquehanna River crossing and a new 100 foot right-of-way for the remainder of the line.

37. The three line route alternatives were compared, and a preferred route was selected. In making the selection, PPL Electric took into consideration public and government input and used three different mathematical models for analyzing the potential impacts of the different routes. PPL Electric considered land use, environmental impacts, social and functional considerations, construction and maintenance impediments, and cost. The preferred route, Alternative 1, was communicated to the public and to municipal, state and federal officials and agencies for further feedback and adjustments, where appropriate.

38. Alternative 1 has many advantages over Alternatives 2 and 3. The primary advantage of Alternative 1 is that it has the lowest cumulative impact. It is the shortest of the three alternatives, and requires the least amount of new rights-of-way. Alternative 1 also requires the least amount of tree clearing, has the shortest river crossing, and therefore, has the least impact on outstanding natural areas.

39. In contrast, although Alternative 2 is slightly less expensive than Alternative 1, it would have the most impact on the Susquehanna River, because it would require construction activities to take place in the river.

40. Both Alternative 2 and 3 would require more extensive tree clearing. In addition, Alternatives 2 and 3 would have a greater impact on outstanding natural areas which are identified in the County Natural Heritage Inventories. Alternative 3 would require the most stream crossings. Alternatives 2 and 3 also both require more extensive private rights-of-way.

41. These observations are borne out by the quantitative analysis of the total impacts of the three alternative routes. PPL Electric used an Ordinal method, Relative Maximum-

Minimum method, and a Relative Z-Score method in order to determine the preferred alternative.

The quantitative analysis and its results can be seen in Attachment 4.

42. Based on the foregoing, PPL Electric concluded that Alternative 1 was the preferable route for the proposed Richfield–Dalmatia Tie Line.

V. PROPERTY FOR WHICH CONDEMNATION IS SOUGHT

43. The route of the proposed Richfield–Dalmatia Line crosses a certain tract of land, a legal description of which is provided in Attachment 5 to this Application. The names and post office address of the owners of record of said land are:

Ronald Mace & Dianne Mace
584 Malta Road
Dalmatia, PA 17017

44. PPL Electric has attempted to purchase a right-of-way and easement over said tract of land for the purposes described above but, to date, has been unable to reach any agreement with the property owners.

45. Prior to commencing negotiations to purchase a right-of-way and easement from Ronald and Dianne Mace, PPL Electric previously disclosed to them that PPL Electric may seek to obtain a right-of-way and easement across the property by eminent domain and furnished information concerning the power of eminent domain by providing the form of notice specified by the Commission at 52 Pa. Code § 57.91.

46. A legal description and map of the right-of-way and easement to be acquired by condemnation are provided in Attachments 6 and 7, respectively, to this Application.

47. The right-of-way and easement sought to be acquired in this Application does not include property used as a burial ground, place of public worship, a dwelling house, or any part of the reasonable curtilage appurtenant of a dwelling house.

VI. THE REQUIREMENTS FOR CONDEMNATION HAVE BEEN SATISFIED

48. No other public utility is now furnishing, or has the corporate authority and certificate to furnish the same service as, or service similar to, that which PPL Electric will furnish by means of the transmission line to be constructed over and upon the right-of-way and easement to be acquired as set forth in this Application.

49. The service to be furnished by PPL Electric through the proposed transmission line and related facilities is necessary or proper for the service, accommodation, convenience, or safety of the public for the reasons set forth in this Application.

50. Appropriate resolutions were adopted by PPL Electric's Board of Directors authorizing and directing this Application. A copy of the applicable resolutions, as certified by the Secretary of PPL Electric, is provided in Attachment 8 to this Application.

VII. CONCLUSION

WHEREFORE, PPL Electric Utilities Corporation respectfully requests that the Pennsylvania Public Utility Commission find and determine that the service to be furnished by PPL Electric through the proposed exercise of eminent domain, as set forth above, is reasonably necessary or proper for the service, accommodation, convenience, or safety of the public.

Respectfully submitted,

Paul E. Russell (Pa. Bar I.D. #21643)
Associate General Counsel
PPL Services Corporation
Two North Ninth Street
Allentown, PA 18101
Voice: 610.774.4254
Fax: 610.774.6726
E-mail: perussell@pplweb.com

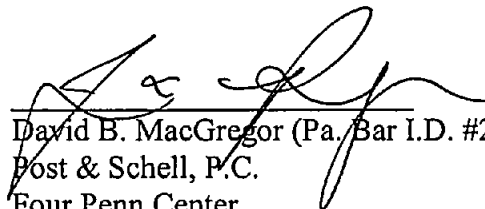
David B. MacGregor (Pa. Bar I.D. #28804)
Post & Schell, P.C.
Four Penn Center
1600 John F. Kennedy Boulevard
Philadelphia, PA 19103-2808
Voice: 215.587.1197
Fax: 215.320.4879
E-mail: dmacgregor@postschell.com

Of Counsel:

Post & Schell, P.C.

John H. Isom (ID # 16569)
Jessica R. Rogers (ID #309842)
Post & Schell, P.C.
17 North Second Street
12th Floor
Harrisburg, PA 17101-1601
Voice: 717.612.6032
Fax: 717.731.1985
E-mail: jisom@postschell.com
E-mail: jrogers@postschell.com

Dated: October 11, 2011

Attorneys for PPL Electric Utilities Corporation

VERIFICATION

:

I, Gregory N. Dudkin, being the Senior Vice President of Operations of PPL Electric Utilities Corporation, hereby state that the facts above set forth are true and correct to the best of my knowledge, information and belief and that I expect that PPL Electric Utilities Corporation to be able to prove the same at a hearing held in this matter. I understand that the statements herein are made subject to the penalties of 18 Pa. C.S. § 4904 relating to unsworn falsification to authorities.

Date: 9/15/11



Gregory N. Dudkin

**BEFORE THE
PENNSYLVANIA PUBLIC UTILITY COMMISSION**

Application Of PPL Electric Utilities :
Corporation Under 15 Pa. C.S. §1511(c) For A :
Finding And Determination That The Service :
To Be Furnished By The Applicant Through :
Its Proposed Exercise Of The Power Of :
Eminent Domain To Acquire A Right-Of-Way :
And Easement Over And Across The Lands Of : Docket No. A-2011-_____

Ronald and Dianne Mace In Lower Mahanoy :
Township, Northumberland County, :
Pennsylvania For The Proposed Richfield- :
Dalmatia 69 kV Transmission Tie Line Is :
Necessary Or Proper For The Service, :
Accommodation, Convenience Or Safety Of :
The Public :

PPL ELECTRIC UTILITIES CORPORATION

STATEMENT NO. 1 - MACE

DIRECT TESTIMONY OF GOPI R. KEDIA

1 Q. Please state your name and business address.

2 A. My name is Gopi R. Kedia. My business address is Two North Ninth Street,
3 Allentown, Pennsylvania 18101.

4

5 Q. By whom are you employed and in what capacity?

6 A. I am employed by PPL Electric Utilities Corporation (“PPL Electric”) as a Principal
7 Engineer.

8

9 Q. What is your educational background?

10 A. I received a Master of Science degree in Electrical Engineering from Lehigh
11 University in 1981. Prior to that, I received a Bachelor of Science degree in
12 Electrical Engineering from Birla Institute of Technology (“BIT”), Ranchi, India, in
13 1969.

14

15 Q Do you hold any professional licenses?

16 A. I have been a licensed Professional Engineer in the Commonwealth of Pennsylvania
17 since August 16, 1982 (# PE-031897E).

18

19 Q. Are you a member of any professional organizations?

20 A. Yes, I am a life member of the Institute of Electrical and Electronics Engineers, Inc.
21 (“IEEE”).

22

23 Q. Describe your experience and employment history with PPL Electric.

1 A. I have been employed by PPL Electric for more than 34 years. I have been in my
2 current position since 1998. In this position, I am responsible for the planning of
3 PPL Electric's transmission system for transmission lines 69 kV and greater for the
4 Harrisburg Region. Prior to 1998, and since I began my employment with PPL, I
5 have held several positions of increasing responsibility within the Company, as
6 follows:

- 7 • 1977 – 1978 Engineer II in Relay and Control Engineering
- 8 • 1978 – 1983 Project Engineer in Relay and Control Engineering
- 9 • 1984 – 1987 Project Engineer in the Substation Engineering Standard's
10 Section
- 11 • 1987 – 1997 Senior Engineer in Substation Engineering

12
13 Q. Have you participated in other transmission line siting projects for PPL Electric?

14 A. Yes. I have worked on more than 12 projects involving transmission lines varying in
15 voltage levels from 69 kV to 230 kV.

16
17 Q. What is the purpose of your testimony?

18 A. My testimony will address the following subjects: (1) the need for the Richfield-
19 Dalmatia 69 kV transmission Tie Line; (2) a description of PPL Electric's system
20 planning process; (3) an explanation of the proposed system, which will solve the
21 problems identified in the planning process; and (4) the benefits of the Richfield-
22 Dalmatia 69 kV Tie Line to PPL Electric and its customers.

23

1 Q. Please provide a brief overview of PPL Electric’s Attachment 1 and identify the
2 portions for which you are responsible.

3 A. Attachment 1 is the Necessity Statement that sets forth the reasons why the
4 Richfield-Dalmatia 69 kV Tie Line is required, explains the functional alternatives
5 considered and describes the factors that led PPL Electric to determine that the
6 Richfield-Dalmatia 69 kV Tie Line is the best alternative to ensure reliable long-term
7 electric service to customers within PPL Electric’s certificated service territory.

8
9 I am responsible for the portions of Attachment 1 which are related to the need for
10 the transmission tie line that will serve as a back up source for the Juniata-Richfield
11 and Sunbury-Dauphin 69 kV Lines. In addition, the Tie Line will serve as the
12 electrical source for the planned Meiserville 69-12 kV Substation.

13
14 Q. Please briefly summarize the findings and conclusions set forth in the Necessity
15 Statement.

16 A. The Richfield-Dalmatia 69 kV Tie Line project will resolve multiple violations of
17 PPL Electric’s Reliability Principles and Practices (“RP&P”) guidelines relating to
18 PPL Electric’s regional transmission system in the area. PPL Electric’s regional
19 transmission system is composed of the 69 kV voltage level transmission lines. The
20 Richfield-Dalmatia 69 kV Tie Line will provide long-term relief to the reliability
21 violations in the regional transmission system identified through PPL Electric’s
22 planning process and will ensure reliable electric transmission service to retail

1 electric customers in the neighboring counties of Snyder, Juniata, and
2 Northumberland.

3
4 In order to avoid significant transmission problems, PPL Electric plans to construct
5 the project with a required in-service date of November 2012. To meet its in-service
6 date, PPL Electric must begin construction in November of 2011. The Richfield-
7 Dalmatia 69 kV Tie Line will be designed for two circuits; however, only one circuit
8 will be installed initially. A second circuit will be added when future load growth
9 makes it appropriate to do so. The entire line will be designed and constructed to
10 operate at 69 kV. In addition, the Richfield-Dalmatia 69 kV Tie Line, together with
11 the Meiserville 69-12 kV Substation and new 12 kV distribution lines that it will
12 supply, are required to resolve numerous violations of the RP&P on PPL Electric's
13 distribution system. The substation and new distribution lines are discussed in the
14 testimony of William Keller, PPL Electric Statement No. 2.

15
16 Q. Does PPL Electric have reliability criteria?

17 A. Yes. The PPL Electric planning guidelines are set forth in its Reliability Principles
18 and Practices ("RP&P"). The RP&P guidelines were developed to ensure adequate
19 and appropriate levels of electric service consistent with good utility practice.
20 Specifically, the process assures that PPL Electric's transmission and distribution
21 systems can supply all customer load in a way that is reliable and economic.

22
23 Q. What are the applicable transmission criteria under the RP&P?

1 A. PPL Electric's transmission systems are planned so that they meet the following
2 guidelines:

- 3 • Normal operation of the system will not load any electric facility beyond its
4 normal continuous rating.
- 5 • In the case of an outage on a single circuit 69 kV transmission line, 60 MW of
6 load can be interrupted for up to 2 hours. After 2 hours, 30 MW of load must be
7 restored by field switching to adjacent transmission lines. After 10 hours, all
8 load must be restored.
- 9 • Large-scale, long-term or frequent interruptions and excessive load loss are to be
10 avoided due to the adverse and potentially hazardous effect they have on the
11 public.

12
13 Q. How does PPL Electric conduct its planning process?

14 A. The PPL Electric planning process begins with the development of a computer
15 model of the future system. A specific study year is chosen and the future system
16 model is developed using the existing system, plus any planned modifications to the
17 transmission system scheduled to be in service or removed from service prior to the
18 study year. Load levels used in the system model are based on the latest forecast
19 prepared annually by the PJM Load Analysis Subcommittee, recent summer peak
20 loads, normal and high temperature indices, and humidity indices.

21
22 Once the system model is complete, comprehensive power flow simulations are
23 performed to determine whether the system complies with the PPL Electric planning
24 reliability criteria. This is accomplished by simulating an outage of each

1 transmission and bulk electric facility. All conditions where the system is not in
2 conformance with the reliability criteria are identified and system reinforcements are
3 identified that would bring the system into conformance. Also identified are
4 estimated costs and lead-times to implement the required reinforcements. Computer
5 simulations of the system with the identified reinforcement alternatives are
6 completed to identify the best overall reinforcement that will meet the needs of the
7 region in a reliable and economic manner.

8
9 Q. What transmission problems were identified in the planning process?

10 A. The area of concern associated with the existing transmission and distribution system
11 receives its electric power supply from PPL Electric's Juniata and Sunbury 230-69
12 kV Substations. By the summer of 2012, in the event of an outage of the Juniata-
13 Richfield 69 kV line, approximately 44 MW of load would remain interrupted after
14 all of the field switching is completed to transfer load to the adjacent lines. Similarly,
15 under 2012 summer peak conditions, for an outage on the Sunbury-Dauphin 69kV
16 transmission line, approximately 33 MW of load would remain interrupted after all
17 field switching moves have been completed.

18
19 In both cases load beyond the permissible limits would remain interrupted until
20 repairs have been completed or additional reinforcements have been provided. This
21 load drop exceeds PPL Electric's RP&P guidelines.

1 Q. How does PPL Electric plan to resolve the transmission and reliability violations
2 identified in the planning process?

3 A. PPL Electric determined that a new 69 kV tie line, to connect the existing Juniata-
4 Richfield 69 kV line to the existing Sunbury-Dauphin 69 kV line, would resolve the
5 transmission violations identified through the planning process. The new tie line will
6 provide a backup source of supply to the Juniata-Richfield and Sunbury-Dauphin 69
7 kV transmission lines for speedy and orderly load restoration in the event of an
8 outage.

9
10 PPL Electric determined that this configuration will resolve all of the RP&P 69 kV
11 transmission violations in the area by providing additional transmission capacity and
12 load transfer capability.

13
14 Q. What functional alternatives were examined to resolve the transmission and
15 reliability violations identified in the planning process?

16 A. PPL Electric considered two functional alternatives. They were as follows:

- 17 • Alternative 1 would construct a new 11 mile long 69 kV line with double circuit
18 design. The line would initially be constructed as a single circuit. The proposed
19 line would extend from the vicinity of the Richfield substation to the vicinity of
20 the Dalmatia substation, tying together the existing Juniata–Richfield and
21 Sunbury—Dauphin 69 kV transmission lines. The estimated cost of this
22 alternative was \$12 million, including the costs of the rights-of-way.

- Alternative 2 would construct a new 15 mile long 69 kV line with double circuit design. The line would initially be constructed as a single circuit. The proposed line would run from the Richfield Tie point on the Sunbury—Middleburg line to the Sunbury Substation 69 kV Yard 2. In addition to the 15 miles of double circuit line, another 5 miles of transmission line would be required to supply the proposed Meiserville 69-12 kV substation. This would also require installation of a new single breaker 69 kV termination in the Sunbury Substation 69kV Yard 2. This alternative would cost an estimated \$22 million.

Q. Which functional alternative was preferable?

A. Alternative 1 was selected.

Q. What made Alternative 1 preferable to Alternative 2?

A. Alternative 1 was selected for two principal reasons. First, it is more economical, and second, it encumbers less land due to the shorter length of new transmission lines. The lead-time required in acquiring the necessary rights-of-way and construction of these lines would be significantly longer for Alternative 2.

Q. Will constructing the Richfield-Dalmatia 69 kV Transmission Tie Line using Alternative 1 provide additional benefits to PPL Electric's customers?

A. Yes, Alternative 1 will allow PPL Electric to improve transmission and reliability without requiring extensive outages of existing facilities for the construction of the new transmission line, thus maintaining the reliable service to customers in this area.

1

2

Alternative 2 would require a new 69kV line termination at the Sunbury 69 kV Yard

3

2. This alternative reinforcement would require PPL Electric to rearrange the

4

existing lines, at an additional cost not factored into the \$22 million estimate. In

5

addition, rearranging existing lines would necessitate extensive outages of affected

6

facilities.

7

8

Q. Does this conclude your direct testimony at this time?

9

A. Yes, it does.

**BEFORE THE
PENNSYLVANIA PUBLIC UTILITY COMMISSION**

Application Of PPL Electric Utilities :
Corporation Under 15 Pa. C.S. §1511(c) For A :
Finding And Determination That The Service :
To Be Furnished By The Applicant Through :
Its Proposed Exercise Of The Power Of :
Eminent Domain To Acquire A Right-Of-Way :
And Easement Over And Across The Lands Of : Docket No. A-2011- _____
Ronald and Dianne Mace In Lower Mahanoy :
Township, Northumberland County, :
Pennsylvania For The Proposed Richfield- :
Dalmatia 69 kV Transmission Tie Line Is :
Necessary Or Proper For The Service, :
Accommodation, Convenience Or Safety Of :
The Public :

PPL ELECTRIC UTILITIES CORPORATION

STATEMENT NO. 2 - MACE

DIRECT TESTIMONY OF WILLIAM KELLER

1 Q. Please state your name and business address.

2 A. My name is William Keller. My business address is Two North Ninth Street,
3 Allentown, Pennsylvania 18101

4

5 Q. By whom are you employed and in what capacity?

6 A. I am employed by PPL Electric Utilities Corporation (“PPL Electric”) as a
7 Supervising Engineer in the Distribution Planning Department.

8

9 Q. What is your educational background?

10 A. I have a Bachelor of Science in Electrical Engineering from the Pennsylvania State
11 University.

12

13 Q. Do you hold any professional licenses?

14 A. I have been a licensed Professional Engineer in the Commonwealth of Pennsylvania
15 since 1974 (# PE-012345E).

16

17 Q. Describe your experience and employment history with PPL Electric.

18 A. I have been employed by PPL EU for approximately one year. Before that, I was
19 employed by Metropolitan Edison, and then First Energy, for over 39 years

20

21 Q. What is the purpose of your testimony?

22 A. My testimony will address the following subjects: (1) the need for the Meiserville
23 69-12 kV Substation; (2) a brief description of PPL Electric’s system planning

1 process; (3) an explanation of the proposed distribution system, which will solve the
2 problems identified in the planning process; and (4) the benefits of the Meiserville
3 69-12 kV Substation to PPL Electric and its customers.

4

5 Q. What portions of the Necessity Statement, PPL Electric's Attachment 1, are you
6 responsible for?

7 A. I am responsible for the portions of Attachment 1 which relate to the need for the
8 planned Meiserville 69-12 kV Substation and the 12 kV distribution system
9 modifications.

10

11 Q. Does PPL Electric have reliability criteria?

12 A. Yes. The PPL Electric planning guidelines are set forth in its Reliability Principles
13 and Practices ("RP&P"). The RP&P guidelines were developed to ensure adequate
14 and appropriate levels of electric service consistent with good utility practice.
15 Specifically, the process assures that PPL Electric's transmission and distribution
16 systems can supply electricity to all customer load in a way that is reliable and
17 economic.

18

19 Q. What are the applicable distribution criteria under the RP&P?

20 A. PPL Electric's goal is to plan distribution systems so that they meet, among others,
21 the following guidelines:

- 22 • A 12 kV distribution line should serve no more than 1,300 customers.
- 23 • A 12 kV distribution line should supply no more than 50 miles of circuit.

1

2 Q. Why is it not desirable for a 12 kV distribution line to supply many miles of circuit?

3 A. The longer the line, the greater the exposure to conditions that could cause outages
4 to customers served by that the line.

5

6 Q. Why is it not desirable for a 12 kV distribution line to serve too many customers?

7 A. The greater the number of customers, the more customers that could potentially be
8 out of service if a line outage were to occur.

9

10 Q. What reliability concerns did PPL Electric identify in its planning process?

11 A. The Dalmatia 36-02 12 kV distribution line, which is supplied by the Dalmatia
12 Substation, in Lower Mahanoy Township, Northumberland County, and stretches
13 across seven townships and a borough in Northumberland, Snyder, and Juniata
14 Counties, currently does not meet PPL Electric's RP&P guidelines for customer
15 count per feeder and circuit miles. The RP&P guidelines provide that no more than
16 1,300 customers should be served from a 12 kV circuit. In addition, the RP&P
17 guidelines provide that a 12 kV circuit should not supply more than 50 miles of
18 circuits. The Dalmatia 36-02 12 kV distribution line currently serves more than
19 2,200 customers and supplies 194 miles of circuit.

20

21 The rural nature of the area, length of the circuit, and high number of customers on
22 the circuit result in a large number of customers experiencing multiple outages per

1 year. The combination of these factors has led to the Dalmatia 36-02 distribution
2 line being among the worst performing circuits on PPL Electric's system.

3

4 Q. How does PPL Electric plan to bring the Dalmatia 36-02 12 kV distribution line into
5 compliance with the RP&P?

6 A. PPL Electric plans to build a new 69-12 kV substation, together with two new 12 kV
7 distribution lines, in order to resolve the problems identified through the planning
8 process. This project will reduce the customer count per feeder and circuit miles to
9 an amount within the RP&P guidelines.

10

11 Q. Where will the Meiserville 69-12 kV Substation be constructed?

12 A. The new Meiserville 69-12 kV Substation will be centrally located to the region it
13 will serve in Susquehanna Township, Juniata County. The substation will be
14 connected to and supplied by the proposed Richfield-Dalmatia 69 kV Tie Line. The
15 substation will also supply two new 12 kV distribution lines to serve customer load
16 in the area, and allow PPL Electric to comply with its RP&P guidelines on the
17 Dalmatia 36-02 distribution line.

18

19 Q. Is PPL Electric filing a petition for a finding exempting a substation building from
20 local zoning requirements?

21 A. No. A building could be subject to a zoning ordinance. The Meiserville 69-12 kV
22 Substation will be a small substation facility, and it is being designed without a
23 building. Therefore, no petition related to zoning issues is required.

1

2 Q. What benefits are there for PPL Electric and its customers in building the Meiserville
3 69-12 kV Substation?

4 A. The new substation will alleviate reliability concerns in the area, and allow PPL
5 Electric to comply with its RP&P guidelines. The substation will also allow PPL
6 Electric to provide more reliable service to the customers living in the area who are
7 currently served by the Dalmatia 36-02 distribution line.

8

9 Q. Does this conclude your direct testimony at this time?

10 A. Yes, it does.

**BEFORE THE
PENNSYLVANIA PUBLIC UTILITY COMMISSION**

Application Of PPL Electric Utilities :
Corporation Under 15 Pa. C.S. §1511(c) For A :
Finding And Determination That The Service :
To Be Furnished By The Applicant Through :
Its Proposed Exercise Of The Power Of :
Eminent Domain To Acquire A Right-Of-Way :
And Easement Over And Across The Lands Of : Docket No. A-2011-_____

Ronald and Dianne Mace In Lower Mahanoy :
Township, Northumberland County, :
Pennsylvania For The Proposed Richfield- :
Dalmatia 69 kV Transmission Tie Line Is :
Necessary Or Proper For The Service, :
Accommodation, Convenience Or Safety Of :
The Public :

PPL ELECTRIC UTILITIES CORPORATION

STATEMENT NO. 3 - MACE

DIRECT TESTIMONY OF JUSTIN B. WEHR

1 Q. Please state your name and business address.

2 A. My name is Justin B. Wehr. My business address is Two North Ninth Street, Allentown,
3 PA 18101.

4
5 Q. By whom are you employed and in what capacity?

6 A. I am employed by PPL Electric Utilities Corporation (“PPL Electric”). My position with
7 PPL Electric is Siting Coordinator in the Transmission Operations Department. In that
8 position, I am responsible for identifying and selecting high voltage transmission line
9 routes and substation locations. I am also responsible for preparing Applications and
10 Attachments for approval by the Pennsylvania Public Utility Commission.

11

12 Q. What is your educational background?

13 A. I received a Bachelor of Science Degree in Environmental Science/Geology with a minor
14 in Geography from Kutztown University of Pennsylvania in 2002. My additional
15 continuing education relevant to my current position includes the following courses and
16 programs:

- 17
- Richard Chinn Environmental Training Inc., ACOE Wetland Delineation
18 /Regional Supplemental Training (2003)
 - Halfmoon LLC, Pennsylvania Land Use and Environmental Issues (2009)
 - Burns & McDonnell, Routing and Permitting on the NEEWS Project
20 (2010)
- 21

22

23 Q. Describe your experience and employment history with PPL Electric.

1 A. I have been employed by PPL Electric for 3 years. I have been in my current position, as
2 Siting Coordinator, since November of 2008. My previous professional experience
3 includes employment at Lehigh Engineering Associates, Inc. from June 2002 until
4 August of 2008. I served in the capacities of Environmental Technician, Environmental
5 Project Manager, and Project Manager. In those roles, I was responsible for
6 environmental permitting activities, grading and drainage calculations, and overall
7 project oversight.

8

9 Q. Have you participated in other transmission line siting projects for PPL Electric?

10 A. Yes. I have worked on more than 10 projects involving transmission lines.

11

12 Q. What are your responsibilities in connection with the Richfield-Dalmatia 69 kV
13 Transmission Tie Line?

14 A. I am responsible for the Alternative Route evaluation and the selection of a preferred
15 route for the Richfield-Dalmatia 69 kV Tie Line. I am also responsible for evaluating
16 and selecting a site for the proposed Meiserville 69-12 kV Substation.

17

18 Q. What are the subjects of your testimony?

19 A. I will describe the Richfield-Dalmatia 69 kV Tie Line, summarize PPL Electric's process
20 to site the line, describe the property of Ronald and Dianne Mace, describe PPL Electric's
21 proposed right-of-way and easement over the property, and provide the history and status
22 of negotiations with Ronald and Dianne Mace.

23

1 Q. Please describe the Richfield – Dalmatia 69 kV Tie Line.

2 A. As explained in the testimony of Gopi Kedia, PPL Electric Statement No. 1, in order to
3 provide additional transmission capacity and load transfer capability to restore loads on
4 the Juniata–Richfield and Sunbury–Dauphin 69 kV lines to meet PPL Electric’s
5 Reliability Principles and Practices (“RP&P”) load drop standards for a single circuit 69
6 kV transmission line outage, PPL Electric proposes to construct the Richfield–Dalmatia
7 69 kV transmission Tie Line. The proposed Richfield–Dalmatia 69 kV Transmission Tie
8 Line will connect the existing PPL Electric Juniata–Richfield 69 kV line in West Perry
9 Township, Snyder County, and the Sunbury–Dauphin 69 kV line in Lower Mahanoy
10 Township, Northumberland County. The proposed line will extend through portions of
11 Snyder, Juniata, and Northumberland Counties. The proposed line will include
12 approximately 11.54 miles of new 69 kV transmission line and will supply the new
13 Meiserville 69-12 kV Substation.

14
15 The Richfield-Dalmatia line, the new substation and new distribution lines will also bring
16 PPL Electric into compliance with the RP&P guidelines for 12 kV distribution lines in
17 the area currently served by the Dalmatia 36-02 12 kV distribution line as explained in
18 the testimony of William Keller, PPL Electric Statement No. 2.

19
20 Q. How did PPL Electric identify alternative routes for the new transmission line?

21 A. PPL Electric determined a general area in which alternative line routes can be feasibly
22 sited to meet the Project’s functional requirements and minimize social impacts,
23 environmental impacts, and project costs. PPL Electric refers to this as the Study Area.

1 For the Richfield-Dalmatia 69 kV Tie Line, the Study Area was between 4.9 and 4.2
2 miles from north to south, and nearly 12 miles from east to west, for a total of 64.2 square
3 miles. The Study Area included portions of Monroe Township and Susquehanna
4 Township in Juniata County, Chapman Township, Perry Township, West Perry
5 Township in Snyder County, and Lower Mahanoy Township, in Northumberland County.

6
7 Once the Study Area was selected, the next step in the route selection process was the
8 identification of routing constraints. Large constraints were identified and avoided to the
9 extent practical. Large constraints included the congested area of Dalmatia, residential
10 development along the west bank of the Susquehanna River, and the State Game Lands
11 #194. After identifying numerous large and small constraints, and receiving input from
12 the local governments and the public, PPL Electric identified three possible alternative
13 routes.

14
15 Q. Please describe the alternative routes PPL Electric considered.

16 A. PPL Electric considered three alternative routes for this line. These routes are:

- 17 • Alternative 1, the selected route, involves the construction of 11.54 miles of new 69
18 kV line that would extend from PPL Electric's Juniata-Richfield 69 kV line in West
19 Perry Township, Snyder County, and run in a southeasterly direction to the Sunbury-
20 Dauphin 69 kV line in Lower Mahanoy Township, Northumberland County. This
21 line would run through Snyder, Juniata, and Northumberland Counties. Alternative 1
22 would require a 150 foot right-of-way at the proposed Susquehanna River crossing
23 and a new 100 foot right-of-way for the remainder of the line.

- 1 • Alternative 2 would involve the construction of 12.49 miles of new 69 kV line that
2 would extend from PPL Electric’s Juniata–Richfield 69 kV line in West Perry
3 Township, Snyder County and would proceed in an east/southeasterly direction to
4 connect with the existing Sunbury–Dauphin 69 kV line in Lower Mahanoy Township,
5 Northumberland County. Alternative 2 would require a new 100 foot right-of-way,
6 and has approximately 2.5 miles in common with Alternative 1.
- 7 • Alternative 3 would involve the construction of 12.07 miles of new 69 kV line from
8 the Juniata–Richfield 69 kV line in Monroe Township, and would proceed in a
9 southeasterly direction to its connection point with the existing Sunbury–Dauphin 69
10 kV line in Lower Mahanoy Township. This alternative would require a 150 foot
11 right-of-way at the proposed Susquehanna River crossing and a new 100 foot right-
12 of-way for the remainder of the line.

13

14 Q. How did PPL Electric determine which of the three identified alternative routes was
15 preferred?

16 A. In making the selection, PPL Electric took into consideration public and government
17 input and used three different mathematical models for analyzing the potential impacts of
18 the different routes. The Company considered land use, environmental impacts, social
19 and functional considerations, construction and maintenance impediments, and cost. PPL
20 Electric used an Ordinal method, Relative Maximum-Minimum method, and a Relative
21 Z-Score method in order to determine the preferred alternative. *See Attachment No. 3 to*
22 *PPL Electric Exhibit 1.* The preferred route was then communicated to the public and to

1 municipal, state and federal officials and agencies for further feedback and adjustments,
2 where appropriate.

3
4 Q. Which route did PPL Electric determine was the most suitable?

5 A. Alternative 1 was selected for the Richfield-Dalmatia 69 kV transmission Tie Line.

6
7 Q. What made Alternative 1 preferable to the other two alternatives?

8 A. Alternative 1 has many advantages over Alternatives 2 and 3. The primary advantage of
9 Alternative 1 is that it has the lowest cumulative impact. It is the shortest of the three
10 alternatives, and requires the least amount of new rights-of-way. Alternative 1 also
11 requires the least amount of tree clearing, has the shortest river crossing, and has the least
12 impact on natural areas.

13
14 In contrast, although Alternative 2 is less expensive than Alternative 1, it would have the
15 most impact on the Susquehanna River, because it would require construction activities
16 to take place in the river. Both Alternatives 2 and 3 would require more extensive tree
17 clearing. Alternative 3 would have a greater impact on natural areas because it crosses
18 the most streams. Alternatives 2 and 3 also both require more extensive private rights-of-
19 way.

20
21 Q. What is the estimated cost of Alternative 1?

22 A. The estimated cost is \$12 million.

1 Q. How many rights-of-way and easements are required for the Richfield-Dalmatia 69 kV
2 transmission Tie Line using Alternative 1?

3 A. PPL Electric needs rights-of-way and easements from 54 landowners. To date, PPL
4 Electric has successfully obtained these from 43 landowners through voluntary
5 transactions.

6

7 Q. Does the route of the proposed Richfield-Dalmatia 69 kV transmission Tie Line cross the
8 property of Ronald and Dianne Mace, which is the subject of this proceeding?

9 A. Yes. The route does cross the property of Ronald and Dianne Mace, as described more
10 fully below. PPL Electric has attempted to purchase a right-of-way and easement over
11 this tract of land for the Richfield-Dalmatia 69 kV transmission Tie Line but, to date, has
12 been unable to reach any agreement with the property owners.

13

14 Q. Please describe the status of negotiations with Ronald and Dianne Mace.

15 A. A PPL Electric Senior Real Estate Specialist delivered the required PUC 15 day notice to
16 Ronald and Dianne Mace on April 9, 2010. The first contact to begin negotiations was
17 made on May 19, 2010. Since that time PPL Electric has made at least 7 attempts to
18 negotiate with Ronald and Dianne Mace by telephone and in person. PPL Electric was
19 unsuccessful in meeting formally with the Maces to negotiate and come to an agreement.
20 Therefore, on October 16, 2010 PPL Electric sent an offer for the proposed easement via
21 certified mail but has been unsuccessful in coming to an agreement. PPL Electric
22 received a return receipt indicating that the Maces had received the October 16 offer.

23

1

2 Q. Prior to these negotiations, did PPL Electric inform Ronald and Dianne Mace that the
3 Company may obtain the right-of-way or easement through the use of eminent domain?

4 A. Yes. On April 9, 2010, PPL Electric delivered to Ronald and Dianne Mace the forms of
5 notice required by the Commission's regulations at 52 Pa. Code § 57.91. In addition,
6 PPL Electric provided information on real estate terms and definitions, electric and
7 magnetic fields, and vegetation management. Copies of these forms are provided as PPL
8 Electric Exhibit JBW-1.

9

10 Q. Have you been to the property of Ronald and Dianne Mace that is the subject of this
11 proceeding?

12 A. Yes, I have visited the property.

13

14 Q. Please describe the property.

15 A. The property is an approximately 48.95 acre parcel located in Lower Mahanoy Township,
16 Northumberland County, Pennsylvania. A majority of the property is currently utilized
17 for agricultural purposes.

18

19 Q. Is this use compatible with a transmission line right-of-way and easement?

20 A. Yes. Row crops are a permitted use.

21

22 Q. Are there any dwellings on the property?

1 A. No, there are no dwellings on the property that is being condemned. There is a dwelling
2 on an adjoining property that is also owned by the Maces, however the distance from the
3 right-of-way to that dwelling is 391 feet.

4
5 Q. Does PPL Electric's proposed right-of-way and easement over the property of Ronald
6 and Dianne Mace property contain any burial grounds or places of worship?

7 A. No, it does not.

8
9 Q. Please describe PPL Electric Exhibit 1.

10 A. PPL Electric Exhibit 1 is the Application to the Commission for a finding that the service
11 to be furnished to the public through the exercise by PPL Electric of the power of
12 eminent domain to acquire a right-of-way and easement over and across the property of
13 Ronald and Dianne Mace is necessary or proper to the service, accommodation,
14 convenience or safety of the public.

15
16 Q. Please explain Attachment No. 1 to PPL Electric Exhibit 1.

17 A. Attachment No. 1 to PPL Electric Exhibit No. 1 is the Necessity Statement for the
18 project, which discusses the reasons why this project is needed.

19
20 Q. Please explain Attachment No. 2 to PPL Electric Exhibit 1.

21 A. Attachment No. 2 to PPL Electric Exhibit No. 1 is a Study Area Environment section
22 which discusses the various features mapped within the Study Area.

23

- 1 Q. Please explain Attachment No. 3 to PPL Electric Exhibit 1.
- 2 A. Attachment No. 3 to PPL Electric Exhibit No. 1 is the Siting Analysis. This Attachment
3 discusses the impacts of the Alternative Routes and the selection of the Preferred Route.
4
- 5 Q. Please explain Attachment No. 4 to PPL Electric Exhibit 1.
- 6 A. Attachment No. 4 to PPL Electric Exhibit No. 1 is the Impact Assessment Scoring. This
7 Attachment is a quantitative comparison of the Alternative Routes.
8
- 9 Q. Please explain Attachment No. 5 to PPL Electric Exhibit 1.
- 10 A. Attachment No. 5 to PPL Electric Exhibit No. 1 is a copy of the metes-and-bounds
11 description of the property of Ronald and Dianne Mace.
12
- 13 Q. Please explain Attachment No. 6 to PPL Electric Exhibit 1.
- 14 A. Attachment No. 6 to PPL Electric Exhibit No. 1 is a copy of the metes-and-bounds
15 description of the portion of the property of Ronald and Dianne Mace over which PPL
16 Electric seeks a right-of-way and easement.
17
- 18 Q. Please explain Attachment No. 7 to PPL Electric Exhibit 1.
- 19 A. Attachment No. 7 to PPL Electric Exhibit No. 1 is a copy of the Plan showing the
20 property of Ronald and Dianne Mace and the portion of the property over which PPL
21 Electric proposes to acquire a right-of-way and easement.
22
- 23 Q. Please explain Attachment No. 8 PPL Electric Exhibit 1.

1 A. Attachment No. 8 to PPL Electric Exhibit No. 1 is a copy of the resolutions of the Board
2 of Directors of PPL Electric authorizing the acquisition of a right-of-way and easement
3 over the portion of the land of Ronald and Dianne Mace described in PPL Electric
4 Attachment No. 6. Those resolutions remain in effect.

5

6 Q. Please explain Attachment No. 9 to PPL Electric Exhibit 1.

7 A. Attachment No. 9 to PPL Electric Exhibit No. 1 is a copy of PPL Electric's Magnetic
8 Field Management Plan. This Attachment describes PPL Electric's current approach to
9 Electric and Magnetic Field mitigation.

10

11 Q. Please explain Attachment No. 10 to PPL Electric Exhibit 1.

12 A. Attachment No. 10 to PPL Electric Exhibit No. 1 is PPL Electric's Design Criteria and
13 Safety Practices. This Attachment describes PPL Electric's current standard design
14 criteria for various voltage classes, and the practices the Company has adopted to
15 increase safety for employees, contractors and the public.

16

17 Q. In your opinion, is the condemnation of this property necessary?

18 A. Yes. PPL Electric must be able to route the Richfield-Dalmatia 69 kV Tie Line over the
19 property of Ronald and Dianne Mace in order to site, construct, and operate lines to
20 relieve the existing and projected overloaded conditions on the Juniata-Richfield and
21 Sunbury-Dauphin 69 kV lines and the Dalmatia 69-12 kV substation. PPL Electric has
22 proposed a reasonable route for the Tie Line. The service to be provided by PPL Electric
23 through the proposed transmission line and related facilities is necessary or proper for the

1 service, accommodation, convenience or safety of the public for the reasons set forth in
2 my testimony and the testimony of Gopi Kedia and William Keller, and in the
3 Application.

4

5 Q. Does this conclude your testimony at this time?

6 A. Yes, it does.

7

Deb Kachel
Sr. Real Estate Specialist
651 Delp Rd
Lancaster, PA 17601
telephone 717-579-3738

PPL Services Corporation
Two North Ninth Street
Allentown, PA 18101-1179



April 8, 2011

Ronald F. and Dianne L. Mace
584 Malta Rd
Dalmatia, PA 17017

Dear Mr. and Mrs. Mace:

PPL Electric Utilities is planning to upgrade the electric service in your area to help ensure a reliable supply of electricity for you and your neighbors, and for people throughout Northumberland County.

Because this line construction is likely to require that we negotiate with you for an easement, I am notifying you in writing as required by the Pennsylvania Public Utility Commission.

Attached are two notices that provide important information. The wording of these notices is set by the Pennsylvania Public Utility Commission and cannot be changed by PPL Electric Utilities. The first notice is about your legal rights during any negotiations. Let me assure you that PPL Electric Utilities plans to do everything possible to reach an amicable financial settlement with you regarding any easements. The second notice is about the work we do to prevent trees from interfering with the safety of power lines.

Pennsylvania Public Utility Commission regulations require that I give you this information at least 15 days in advance of any specific discussions regarding the easements we will be seeking. If you have any questions regarding this information, please contact me at the number provided below.

Please sign in the space provided below to indicate that you have received this information.

Very truly yours,

Deb Kachel
PPL Senior Real Estate Specialist

I acknowledge receiving the information referred to in the letter above and understand that it does not obligate me in any way.

Signature

Date

Telephone

GLOSSARY OF COMMON REAL ESTATE TERMS

ABSTRACT OF TITLE – The condensed history of ownership to a particular parcel of real estate, consisting of a summary of ownership from a given time to the present owner.

ACRE – A measure of land equal to 43,560 square feet.

APPRAISAL – An estimate of the value of property. The process through which conclusions of property value are reached.

APPRECIATION – An increase in the worth or value of a property.

CHAIN OF TITLE – A history of ownership of a particular property (see abstract of title).

CONDEMNATION – A judicial or administrative proceeding to exercise the power of eminent domain through which private property is taken for public use.

CONDUCTOR – The wire which carries electric energy.

CONVEYANCE – A transfer of property ownership.

DEED – A written document that, when executed and delivered, conveys title to or an interest in real estate.

DEED RESTRICTIONS – Clauses in a deed limiting the use of the property.

DEPRECIATION – A loss of value in property.

EASEMENT – A right to use the land of another for a specific purpose. (Such as a right of way for utilities.)

EGRESS – The right to exit a tract of land.

EMINENT DOMAIN – The right of a government, municipal body or public utility to acquire property for public use. (See condemnation)

ENCROACHMENT – An intrusion, such as a house, sign, wall or fence, that intrudes on another's property or right of way.

FAIR MARKET VALUE – The highest price which a willing buyer would pay and the lowest price a willing seller would accept.

FEE OR FEE SIMPLE – The complete and absolute ownership of real estate.

GRANT – The transfer of property rights through a legal document.

GRANTEE – One who acquires property or any property rights from another person.

GRANTOR – One who transfers property or any property rights to another person.

INGRESS – The right to enter a tract of land.

KV – Kilovolt or 1000 volts (138 KV = 138 x 1000)

LIEN – A claim against real or personal property for satisfaction of a debt.

METES-AND-BOUNDS DESCRIPTION – A legal description of a parcel of land that begins at a well – marked point and follows the boundaries, using directions and distances.

MONUMENT – A fixed natural or artificial object used to establish real estate boundaries.

OPTION – The right to purchase a certain property at stated terms, price and time.

RECORDING – The act of entering documents in the Recorder of Deeds office established in each county.

RIGHT OF WAY – Used interchangeably with the word easement. (See easement)

SURVEY – the process of scientifically measuring the quantity and location of a parcel of land.

TAX MAP – Maps used by the county Tax Assessment office showing the locations of properties.

TITLE – The evidence of ownership of land.

ZONING – The regulation of the use of land and/or buildings.

NOTICE

The Pennsylvania Public Utility Commission requires that PPL Electric Utilities Corporation (PPL) give you the following information on the RIGHT OF WAY MAINTENANCE PRACTICES for the PPL Richfield Dalmatia line.

The methods currently used by PPL are set forth in PPL's "Program for Vegetation Management", which will be made available to you for your inspection upon request. If you wish further information concerning right of way maintenance methods, you may contact the person named on the cover letter. You may discuss with this person, either before or during negotiation of the right of way agreement, these methods and any other questions you may have about right of way maintenance.

Once a utility has constructed an electric transmission line on a right of way across your land, the utility must maintain the right of way free of tall growing trees and brush which might impair the reliability of electric service, the safety of the line, and access to the line or its towers. The utility or its contractors may remove and control tall growing trees and brush by several methods: handcutting of trees, limbs and brush; mechanical cutting with chain saws or motorized cutting machines; application of herbicides, either from the ground or from a helicopter. The utility must confine its maintenance activities to the approved right of way across your land, except where tall growing trees or brush or their root systems grow into the right of way from adjoining land and constitute a threat to the electric transmission line and its structures.

If you believe that the maintenance method(s) used by the company would raise problems with your use of your land adjacent to the right of way, it is your responsibility as the landowner to bring this to the attention of the utility before you sign the right of way agreement.

The utility company has the responsibility to maintain its right of way, and regular maintenance must occur. Although you as the landowner cannot determine whether or not maintenance will occur, your right of way agreement may specify certain conditions on the performance of the maintenance program which are important to you. These conditions can be part of the negotiations between you and the utility company for your land, since a right of way agreement is a legal contract between a landowner and a utility company. It is important for you to understand also that the maintenance methods used by the utility company may change over time as the costs of maintenance or the methods of performing maintenance change. You may want to specify in your right of way agreement that the utility company inform you of changes in its maintenance methods or in the maintenance schedule for your land.

The provisions of the right of way agreement are enforceable in the local Court of Common Pleas. The right of way agreement cannot be enforced by the Pennsylvania Public Utility Commission. Any claims for damages resulting from improper

JBW-1-Mace

maintenance of the right of way must be settled with the utility, its contractors, or in the local Court of Common Pleas at your own expense. The Commission cannot award damages for violations of the right of way agreement.

NOTICE

The Pennsylvania Public Utility Commission requires that PPL Electric Utilities Corporation give you the following information:

PPL Electric Utilities Corporation is presently planning to construct a 69kV electric transmission line to be known as the Richfield-Dalmatia line, in Northumberland County.

Since a field survey and detailed engineering have not been completed, the physical dimensions of the proposed line and the type and height of supporting structures to be used cannot be precisely determined at this time. However, based on past experience and assuming relatively flat terrain along the line route, it is expected that the structures normally will be 95 feet in height. There may be isolated physical conditions that would require either higher or lower structures than those mentioned above. At this time we do not know the number of structures to be placed on any properties. The proposed right of way generally will be 100 feet in width.

Since the route could affect your property. A representative of the Utility will contact you in the near future to discuss the company's plans. In order to better prepare you for these discussions and to avoid possible misunderstandings, we want to take this opportunity to inform you of your legal rights and the legal rights of PPL Electric Utilities Corporation with regard to this project. You have the right to have legal counsel represent you in any negotiations. You do not have to sign any agreement without the advice of counsel. If you do not know an attorney you may contact your local bar association.

MUST YOU ACCEPT ANY OFFER MADE BY THE UTILITY FOR YOUR PROPERTY?

No. You may refuse to accept it. However, the utility has the power to take property by eminent domain, subject to the approval of the Public Utility Commission, for the construction of transmission lines if the utility is unable to negotiate an agreement to buy a right of way. If your property is condemned, you must be paid "just compensation." "Just compensation" has been defined by the courts in Pennsylvania as the difference between the fair market value of your property before condemnation, unaffected by the condemnation, and the fair market value of your remaining property after condemnation, as affected by the condemnation.

CAN THE UTILITY CONDEMN YOUR HOUSE?

No. The company cannot condemn your house or a reasonable "curtilage" around your house. Generally, "curtilage" includes the land or buildings within 100 meters of your house which are used for your domestic purposes. However, the 100 meters limit does not automatically extend beyond the homeowner's property line.

DO YOU HAVE A RIGHT TO A PUBLIC HEARING WHEN THE UTILITY SEEKS TO CONDEMN YOUR PROPERTY?

Yes. When an electric utility seeks to have your property condemned, the utility must first apply to the Pennsylvania Public Utility Commission for a certificate finding the condemnation to be necessary or proper for the service, accommodation, convenience, or safety of the public. The Commission will then hold a public hearing. As the landowner whose property may be condemned, you are a party to the proceeding and may retain counsel, present evidence, and/or testify yourself in opposition to the application for a certificate. If you wish to testify at the public hearing, you should make your intention known by letter to Secretary, Pennsylvania Public Utility Commission, P.O. Box 3265, Harrisburg, PA 17120.

If the commission approves the utility's application for a certificate finding the condemnation in the public interest, then the utility may proceed before the local Court of Common Pleas to condemn your land. If the Commission denies the utility's application, the utility cannot condemn your land. If you retain an attorney to represent you before the Commission, you must do so at your own expense.

The Commission will not decide how much money you should receive if your land is condemned. The only issue the Commission will decide is whether the condemnation serves the public interest. If the Commission approves the utility's application for condemnation, the amount of money to which you are entitled will be determined by a local Board of View of the Court of Common Pleas. However, you may at any time make an agreement with the utility as to the amount of damages you are to be paid.

national organizations and actual participation by PPL employees and customers. We're also providing information to customers and others interested in the subject. EMF coordinators have been assigned to serve as local contact points for EMF inquiries. PPL representatives are available to talk with groups interested in EMF. PPL also has an EMF issue manager who directs all aspects of the company's EMF program.

For more information on EMF, or any other subject related to your electricity service, please call 1-800-DIAL-PPL (1-800-342-5775).



Electric and Magnetic Fields

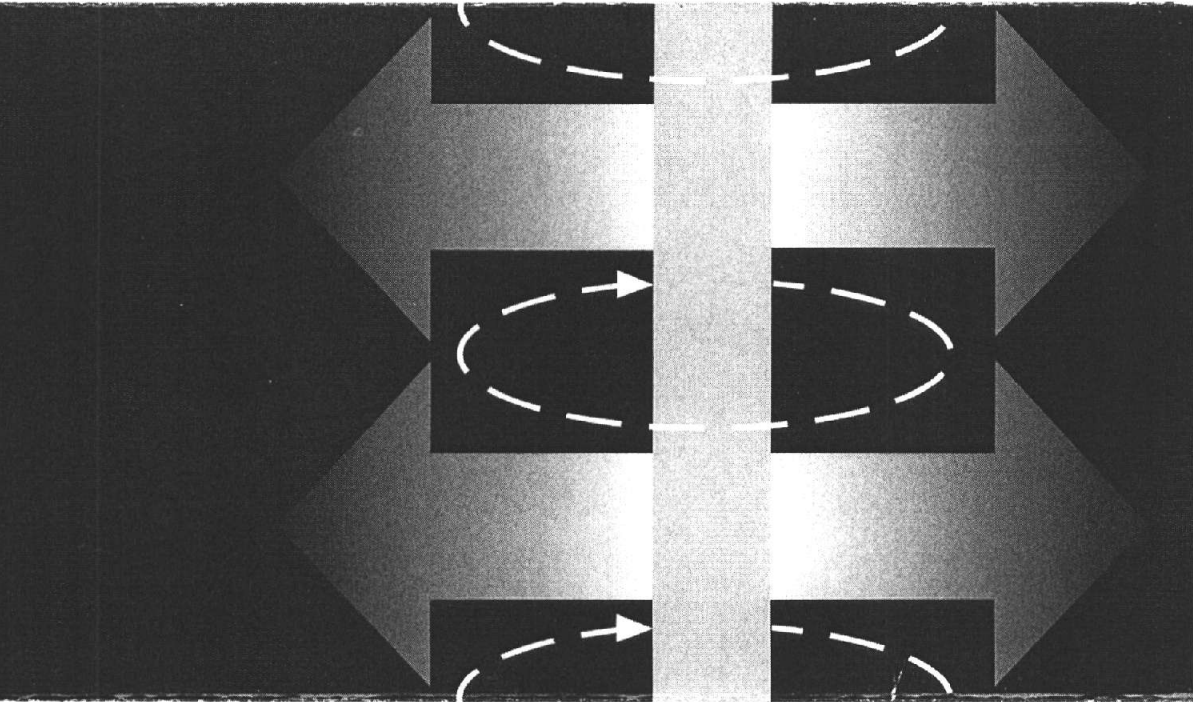

Electric and Magnetic Fields
Electric and magnetic fields (EMF) occur in nature and in all living things. The Earth, for instance, has a static magnetic field, which makes the needle on a compass point north.

Electric fields and magnetic fields of a different type also surround every wire that carries electricity. In everyday life, these EMF arise from many basic sources, including electrical appliances and equipment, home and building wiring, power lines, other utility lines and cables, and currents flowing on water pipes. Though they can often occur together, EMF are made up of two separate components:

- **Electric Fields**

Electric fields are produced by the voltage, or electrical pressure, on a wire. The higher the voltage, the higher the electric field. As long as a wire is energized, that is, has voltage present, an electric field is present (see figure 1). In other words, an appliance or an electric power line doesn't actually have to be turned on to create an electric field. It just has to be plugged in. Electric fields diminish with distance and can be blocked or partially shielded by objects such as trees and houses.

- **Magnetic Fields**

Magnetic fields are created by the current or flow of electricity through a wire. Generally speaking, the higher the current, the higher the magnetic field. Because they only occur when current is flowing, magnetic fields are present only when

the power is turned on (see figure 1). Magnetic fields also diminish with distance, but — unlike electric fields — they are not blocked by common objects such as trees and houses.

Measuring Magnetic Fields

Magnetic fields usually are measured in a unit called a milligauss (mG). Magnetic field levels found in the living areas of homes away from appliances typically range from less than 1 mG to about 4 mG, according to the U.S. Environmental Protection Agency. They can be higher in some cases. The magnetic fields near appliances can exceed 1,000 mG. Figures 2 and 3 show how the strength of the field falls as you move away from the source.

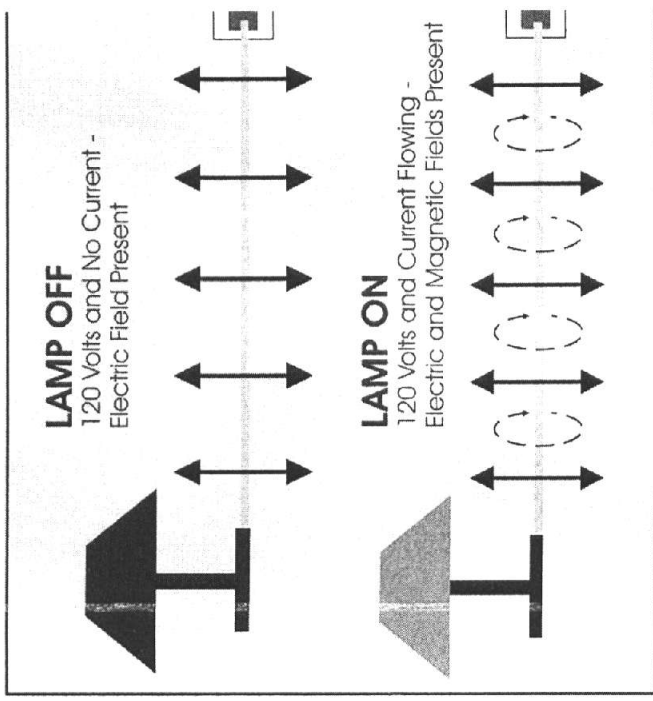

FIGURE 1









| Magnetic field strengths decrease with distance | | Source: National Institute of Environmental Health Sciences (2002) | |
|---|---|--|-----------|
| Magnetic fields are measured in milligauss | | At 6 inches | At 2 feet |
| Clothes dryer |  | 2 to 10 | * to 3 |
| Microwave oven |  | 100 to 300 | 1 to 30 |
| Toaster |  | 5 to 20 | * to 7 |
| Power drill |  | 100 to 200 | 3 to 6 |
| Can opener |  | 500 to 1500 | 3 to 30 |
| Mixer |  | 30 to 600 | * to 10 |
| Hair dryer |  | 1 to 700 | * to 10 |
| Color television |  | Data not available | * to 8 |

FIGURE 2 * The magnetic field measurement at this distance from the operating appliance could not be distinguished from background measurements taken before the appliance had been turned on.

MF Research

Two main types of studies — laboratory and epidemiological — are used to investigate either exposure to things like EMF, chemicals or medicines are beneficial or harmful to humans. Both types have been used over the years to study whether EMF associated with electricity can affect our health. As discussed in more detail below, reviews of the scientific research by credible agencies and panels have concluded that EMF has not been shown to cause or contribute to any disease or illness. In addition to the health studies, researchers are doing exposure assessment studies to determine the amount of EMF exposure occurring around various sources, occupations and activities.

The utility industry has been supporting EMF research by scientists at universities, medical schools and independent research laboratories. The National Cancer Institute, the National Institute of Environmental Health Sciences and the U.S. Department of Energy have supported EMF studies by health and medical scientists. In 1992, the Energy Policy Act authorized \$65 million for a national research and communications program under the general direction of the U.S. Department of Energy and the National Institute of Environmental Health Sciences. PPL supported this program and similar programs in Canada, Italy, Sweden and the United Kingdom also have supported EMF research.

Scientific Reviews

Since the 1970s, many credible scientific panels, government agencies and public health entities have reviewed the scientific research on EMF. Evaluations have been conducted by the U.S. National Academy of Sciences, the U.S. National Institute of Environmental Health Sciences, the U.K. National Radiological Protection Board, the International Agency for Research on Cancer and the World Health Organization, among others. None of these review groups has found that there is a demonstrated cause and effect relationship between exposure to EMF and cancer or other diseases.

In 1999, the director of NIEHS sent a detailed report on EMF and health to U.S. Congress. The report concluded that “the scientific evidence suggesting that ELF-EMF exposures pose any risk is weak.” The NIEHS report noted that while some epidemiology studies showed associations with some leukemias, there was no support for these findings in laboratory research. The NIEHS report concluded that “this finding is insufficient to warrant an aggressive regulatory concern.” The NIEHS issued updated information on EMF in 2002, which concluded that for most health outcomes there is no evidence of EMF causing adverse effects, although there is some evidence of an

association with childhood leukemia, which is difficult to interpret without supporting laboratory evidence. The NIEHS 2002 update concludes that “[a]lthough questions remain about the possibility of health effects related to EMF, recent reviews have substantially reduced the level of concern.” NIEHS did not recommend regulatory action to reduce EMF levels. The NIEHS information about EMF can be found online at www.niehs.nih.gov/health/topics/agents/emf/.

PPL’s View on EMF

Given those conclusions, PPL is taking a reasoned, prudent approach in responding to the EMF issue.

PPL has a magnetic field management program to design and build new lines when possible in ways that allow us to reduce magnetic fields at low cost to our customers. For instance, we reverse the phases of new overhead double-circuit transmission lines, which results in some cancellation of magnetic fields from the line and lowers the magnetic fields at the edge of the right of way. PPL also is increasing ground clearances for transmission lines. On distribution lines, we’re reducing magnetic fields at ground level by using taller poles. Magnetic field management is considered in the process we use to site new facilities, balancing cost and function with land use and environmental concerns. PPL has supported EMF research, both through financial contributions to

Magnetic fields near overhead electric power lines

For overhead power lines, the strength of the magnetic field is dependent upon a number of factors, such as the height of the wires, current flow, wire configuration and the distance from the lines. These factors produce a magnetic field that drops off rapidly as you move away from the power line.

| Type of overhead power line | Distance from the line | | |
|-----------------------------|------------------------|---------|----------|
| | Under the line | 50 feet | 100 feet |
| 220 and 500 kV | 5-400 | 5-250 | 1-75 |
| 69 and 138 kV | 3-80 | 0.5-25 | 0.1-10 |
| 12 kV and below | 0.4-20 | 0.1-1 | - |

FIGURE 3 Magnetic fields are measured in milligauss.

The magnetic field values provided in this table represent a general range of values associated with the types of overhead power lines listed and are provided for illustration. There will be circumstances in which there will be magnetic field levels above or below the range of values provided due to variations in such factors as height of the wires, current flow and so on.

SMALL TREES - UNDER 30 FT.

1. Acer Campestre - Hedge Maple
2. Acer Ginnola - Amur Maple
3. Acer Spicatum - Mountain Maple
4. Acer Tataricum - Tatarian Maple
5. Amerlanchier Canadensis - Shadbush - Seviceberry
6. Amerlanchier Loevis - Allegheny Seviceberry
7. Carpinus Caroliniana - Blue Beech/American Hornbeam
8. Cercis Canadensis - Redbud
9. Cornus Florida - Flowering Dogwood
10. Cornus Kousa - Chinese Kousa Dogwood
11. Crataegus Monogyna - Crab Apple
12. Crataegus Phaenopyrum - Washington Hawthorn
13. Halesia Carolina - Carolina Silverbell
14. Holly
15. Juniperus Virginiana - Juniper
16. Malus - Crab Apple (American)
17. Prunus Sargentii Columnare - Columnar Sargent Cherry
18. Prunus Serrulata Amanogaws - Amanogawa Cherry
19. Prunus Serrulata Kwanzan - Kwanzan Cherry
20. Pyrus Calleryana Chanticleer - Chanticleer Pear
21. Salix Humilis - Dwarf Willow
22. Syringa Amurense Japonica - Japanese Tree Lilac
23. Taxus Canadensis - American Yew
24. Wstrya Virginiana - Ironwood
25. Viburnums

CRABAPPLE (SNOWDRIFT)

(malus spp.)

GROWTH HABITS:

- moderate growth rate
- grows to 20 feet tall
- hardy, scab resistant
- height of head can be raised to accommodate vehicle and pedestrian traffic



CRAB APPLE

EASTERN REDBUD

(cercis canadensis)

GROWTH HABITS:

- growth 35 feet
- global shape
- moderate growth rate
- early spring blossoms
- grows in full sun or light shade
- rarely requires pruning

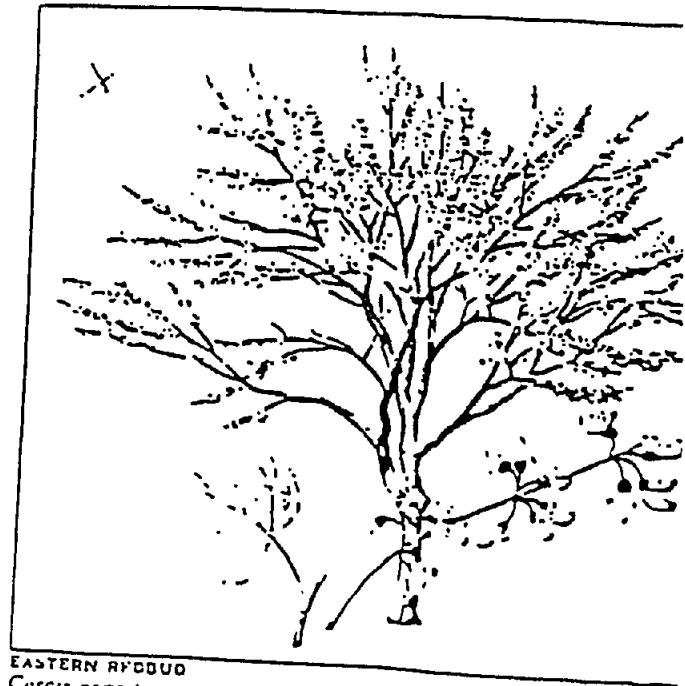

EASTERN REDBUD
Cercis canadensis

GOLDEN-RAIN TREE

(*koelreuteria paniculata*)

GROWTH HABITS:

- slow to moderate growth rate
- grows to 25 to 35 feet tall
- flowers in mid-summer
- tolerates polluted air of cities
- withstands heat and drought
- tolerates all but acid soils



GOLDEN-RAIN TREE
Koelreuteria paniculata

HEDGE MAPLE

(*acer campestre*)

GROWTH HABITS:

- slow growth rate
- grows to 25 ft. tall
- needs little maintenance
- usually pest-free
- tolerates automobile exhaust fumes
- excellent in dry locations

Plant to the side of the right-of-way
(do not plant directly under the power
line).

JBW-1-Mace

RUSSIAN OLIVE

(*elaeagnus angustifolia*)

GROWTH HABITS:

- moderate to fast growth rate
- grow to 25 feet tall
- fragrant yellow flower
- relatively pest free
- endures high wind and drought
- withstands city conditions

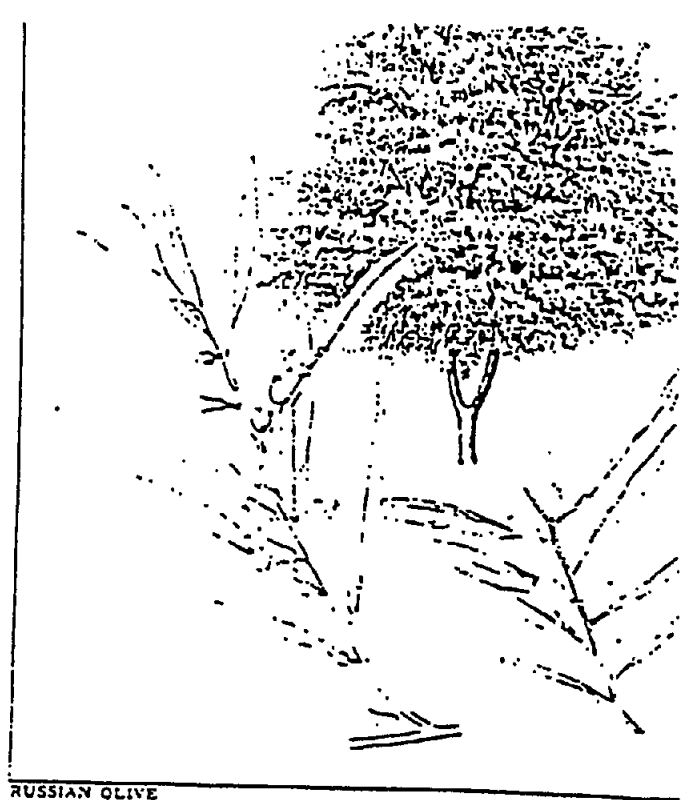

RUSSIAN OLIVE
Elaeagnus angustifolia

WASHINGTON HAWTHORN

(*crataegus phaenopyrum*)

GROWTH HABITS:

- moderate growth rate
- grows to about 30 feet
- tolerates extreme city conditions



WASHINGTON HAWTHORN
Crataegus phaenopyrum

KWANZAN ORIENTAL CHERRY

(*Prunus serrulata* 'Kwanzan')

GROWTH HABITS:

- grows 15 to 25 feet tall
- with stiffly upright branches
- widely available from nurseries
- grafted tree
- pink Spring flower

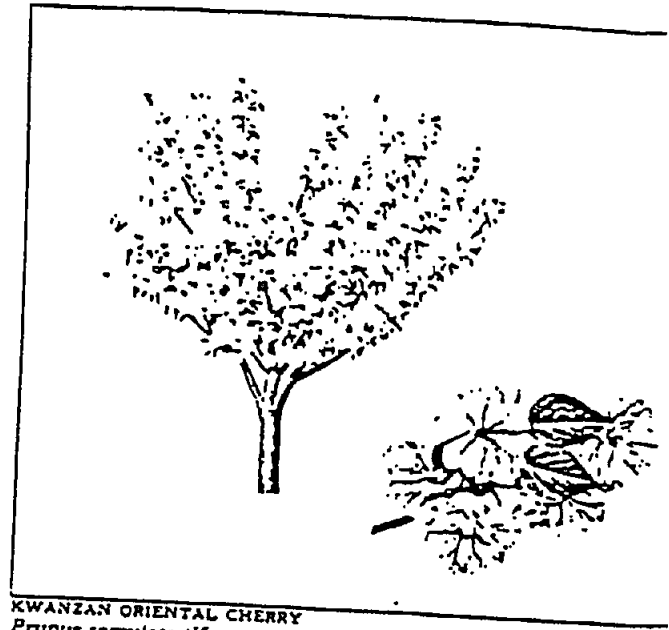

KWANZAN ORIENTAL CHERRY
Prunus serrulata 'Kwanzan'

JBW-1-Mace

V M
estation management

We All Can Live With



nergy in
Harmony
with the
Environment.



P

P.L. is committed to
providing safe and
reliable electric service
in an environmentally
responsible manner.



PPL Electric Utilities
Two North Ninth St.
Allentown, Pa. 18101-1179

Why Must the Taller Vegetation Under Power Lines be Controlled?

PPL operates about 35,000 miles of transmission and distribution power lines. Unfortunately, taller species of trees permitted to grow under our power lines will eventually contact the wires, causing service interruptions and unsafe conditions.

We are committed to providing safe and reliable electric service, and we are committed to responsible environmental stewardship. To balance these commitments, we manage the vegetation in our rights-of-way by controlling the growth of taller trees in ways that protect other plants and wildlife.

What Will be Done?

PPL uses herbicides in careful combination with natural, biological controls to maintain the vegetation in our rights-of-way. Only trees that will grow tall enough to interfere with the overhead power lines are treated. To better target these trees, all herbicides are applied selectively by Pennsylvania Department of Agriculture certified contractors working on the ground with hand-held equipment.

The lower-growing trees and shrubs are preserved as much as possible, since they provide natural competition for the tall-growing species of

trees. This low-growing plant community also provides ideal habitat for wildlife that feeds on many of the tall-growing trees.

The combined effects of the plant competition

and the wildlife activity help minimize

the herbicides needed to ensure safe and reliable electric

lines.



JBW-1-Mace

Why Doesn't PPL Simply Cut the Tall-Growing Trees?

TALL growth could be kept out of electric lines either by cutting the taller trees or by mowing the right-of-way with large equipment. But both methods have drawbacks.

Large-scale mowing of the right-of-way is a poor choice for several reasons. The steep, rocky terrain in most of our

service territory makes it difficult to use such large equipment safely or effectively. Also, repeated use of this type of machinery actually stimulates growth from both the stumps and the root systems of the tree species we are trying to eliminate. Where one stem is cut, you may actually see

several new sprouts the next growing season. Finally, the blades from these machines loosen the soil, increasing the potential for erosion and providing an excellent seedbed for many of the invading tree species we are trying to control.

PPL's many miles of power lines cross a large service territory. Hand cutting tall growth is labor intensive and time consuming. Exclusive use of hand cutting vegetation would seriously jeopardize the safety and reliability of our system. And as with mowing, if the stumps remaining from cutting are not treated with some type of herbicide, new growth will sprout.

What Effect Will This Herbicide Application Have on Wildlife and the Environment?

PPL is committed to managing vegetation in ways that will have a minimal impact on our environment.

We will apply only products that have been approved for use on utility rights-of-way by the U.S. Environmental Protection Agency. These products have undergone significant testing to ensure that when used according to



the environment. In fact, some of the materials we will use are the same as those commonly used by homeowners.

Herbicide application, in the past, generated a significant

amount of solid waste in the form of plastic containers. These containers had to be triple-rinsed and disposed of in a landfill. PPL now requires its contractors to purchase herbicide concentrates in returnable/refillable containers when available. This requirement helps to minimize

the solid waste generated by our vegetation management program and is another way of safeguarding our environment. Finally, there are significant, well-documented benefits resulting from the selective

herbicide application

techniques employed by PPL. Ideal

wildlife habitat is created within these right-of-way corridors. Also, many of the naturally occurring plant and tree species (rhododendron, flowering dogwood, wildflowers) left undisturbed on the right-of-way are aesthetically pleasing.

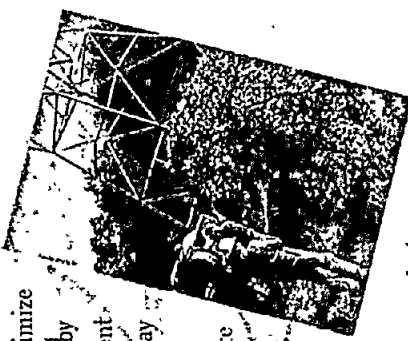

Do You Have Other Questions?

WE hope this information has been of interest to you and that it has answered any questions you might have about the work our contractor will perform on our right-of-way. If you have additional questions, please feel free to contact the contractors or your local PPL foresters. They will do their best to answer your

questions or not you in touch with someone who can

JBW-1-Mace

Vegetation **M**anagement

We All Can Live With

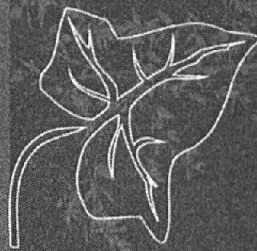

nergy in
Harmony
with the
Environment.

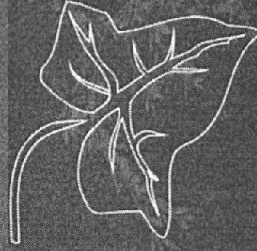

P

P.L. is committed to
providing safe and
reliable electric service
in an environmentally
responsible manner.



PPL Electric Utilities
Two North Ninth St.
Allentown, Pa. 18101-1179

Why Must the Taller Vegetation Under Power Lines be Controlled?

PPL operates about 35,000 miles of transmission and distribution power lines. Unfortunately, taller species of trees permitted to grow under our power lines will eventually contact the wires, causing service interruptions and unsafe conditions.

We are committed to providing safe and reliable electric service, and we are committed to responsible environmental stewardship. To balance these commitments, we manage the vegetation in our rights-of-way by controlling the growth of taller trees in ways that protect other plants and wildlife.

What Will be Done?

PPL uses herbicides in careful combination with natural, biological controls to maintain the vegetation in our rights-of-way. Only trees that will grow tall enough to interfere with the overhead power lines are treated. To better target these trees, all herbicides are applied selectively by Pennsylvania Department of Agriculture certified contractors working on the ground with hand-held equipment.

The lower-growing trees and shrubs are preserved as much as possible, since they provide natural competition for the tall-growing species of trees. This low-growing plant community also provides ideal habitat for wildlife that feeds on many of the tall-growing trees.

The combined effects of the plant competition and the wildlife activity help minimize the herbicides needed to ensure safe and reliable electric lines.



JBW-1-Mace

Why Doesn't PPL Simply Cut the Tall-Growing Trees?

TALL growth could be kept out of electric lines either by cutting the taller trees or by mowing the right-of-way with large equipment. But both methods have drawbacks.

Large-scale mowing of the right-of-way is a poor choice for several reasons. The steep, rocky terrain in most of our

service territory makes it difficult to use such large equipment safely or effectively. Also, repeated use of this type of machinery actually stimulates growth from both the stumps and the root systems of the tree species we are trying to eliminate. Where one stem is cut, you may actually see several new sprouts the next growing season. Finally, the blades from these machines loosen the soil, increasing the potential for erosion and providing an excellent seedbed for many of the invading tree species we are trying to control.



PPL's many miles of power lines cross a large service territory. Hand cutting tall growth is labor intensive and time consuming. Exclusive use of hand cutting vegetation would seriously jeopardize the safety and reliability of our system.

And as with mowing, if the stumps remaining from cutting are not treated with some type of herbicide, new growth will sprout.

What Effect Will This Herbicide Application Have on Wildlife and the Environment?

PPL is committed to managing vegetation in ways that will have a minimal impact on our environment.

We will apply only products that have been approved for use on utility rights-of-way by the U.S. Environmental Protection Agency. These products have undergone significant testing to ensure that when used according to

the environment. In fact, some of the materials we will use are the same as those commonly used by homeowners.

Herbicide application, in the past, generated a significant

amount of solid waste in the form of plastic containers. These containers had to be triple-rinsed and disposed of in a landfill. PPL now requires its contractors to purchase herbicide concentrates in returnable/refillable containers when available. This

requirement helps to minimize the solid waste generated by our vegetation management program and is another way of safeguarding our environment. Finally, there are significant, well-documented benefits resulting from the selective

herbicide application

techniques employed by PPL. Ideal

wildlife habitat is created within these right-of-way corridors. Also, many of the naturally occurring plant and tree species (rhododendron, flowering dogwood, wildflowers) left undisturbed on the right-of-way are aesthetically pleasing.

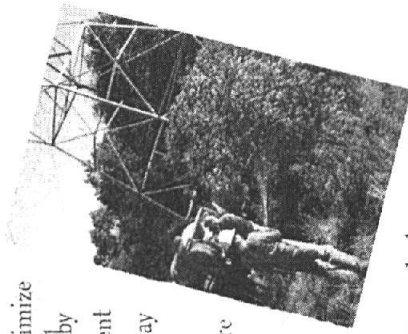

Do You Have Other Questions?

WE hope this information has been of interest to you and that it has answered any questions you might have about the work our contractor will perform on our right-of-way. If you have additional questions, please feel free to contact the contractors or your local PPL foresters. They will do their best to answer your

questions or not want to touch with someone who can

CUSTOMERS INVESTORS BUSINESS PARTNERS ENVIRONMENT & COMMUNITY

NEWSROOM ABOUT CONTACT CAREERS PPL COMPANIES

PPL \$28.51

SEARCH GO

OUR COMMUNITIES

Responding to Needs
Environmental Preserves
Giving

OUR EDUCATION PROGRAMS

About Education Relations
Strengthening Education
Energy Education
Environmental Education
Available Curricula
Education Support Programs
Environmental Education Grants
Teacher (TEA) Workshops

THE NATURE NOTEBOOK

About "The Nature Notebook"
Broadcasts

OUR ENVIRONMENT

Air Emissions
Carbon Disclosure Project
Climate Change Policy
Environmental Reporting
Management Philosophy
Remediation
Restoring Habitats
The Plaza
Vegetation Management
Waste Management

ENERGY FOR THE FUTURE

Clean Energy

SEEKING INPUT

Our Neighbors

ADDITIONAL RESOURCES

PPL Speakers Bureau
Calendar of Events

CONTACT

Directions to PPL Facilities
Contact PPL

ENVIRONMENT & COMMUNITY



ppl corporation > community partners > our environment > vegetation management compatible spec

Vegetation Management

Compatible Species List

This is a list of species of trees and shrubs that are generally acceptable for planting in the vicinity of transmission lines because of their growth rates and typical peak heights.

1. Small trees

- a) Flowering Dogwood (*Cornus florida*)
- b) Redbud (*Cercis canadensis*)
- c) Hawthorn (*Crataegus* spp.)
- d) Blue Beech (American Hornbeam) (*Carpinus caroliniana*)
- e) Shadbush (Juneberry, Serviceberry) (*Amelanchier* spp.)
- f) Eastern Red Cedar (*Juniperus virginia*)
- g) Northern White Cedar (*Thuja occidentalis*)
- h) American Chestnut (*Castanea dentata*)
- i) Dwarf Willow (*Salix* spp.)
- j) Deciduous Holly (Winterberry) (*Ilex verticillata*)

2. Large shrubs

- a) Alder (*Alnus* spp.)
- b) Witch-hazel (*Hamamelis virginiana*)
- c) Spicebush (*Lindera benzoin*)
- d) Common Chokecherry (*Prunus virginiana*)
- e) Elderberry (*Sambucus* spp.)

JBW-1-Mace

- f) Rhododendron (*Rhododendron maximum*)
- g) Viburnum (*Viburnum spp.*)
- h) Dogwood (*Cornus spp.*)
- i) Smooth (Dwarf) Sumac (*Rhus glabra*)
- j) Staghorn Sumac (*Rhus typhina*)
- k) Chokeberry (*Pyrus arbutifolia*)

3. Small shrubs

- a) Mountain Laurel (*Kalmia latifolia*)
- b) American Yew-Ground Hemlock (*Taxus canadensis*)
- c) Sweetfern (*Comptonia peregrina*)
- d) Honeysuckle (*Lonicera spp.*)
- e) Huckleberries (*Gaylussacia spp.*)
- f) Blueberries (*Vaccinium spp.*)
- g) Viburnums (*Viburnum spp.*)
- h) Meadowsweet (*Spirea spp.*)
- i) Wintergreen (*Gaultheria procumbens*)
- j) Trailing Arbutus (*Epigaea repens*)
- k) Blackberry (*Rubus allegheniensis*)
- l) Raspberry (*Rubus occidentalis*)
- m) Hazlenut (*Corylus spp.*)
- n) Scrub Oak (*Quercus spp.*)

4. All native grasses, ferns and herbaceous plants.

[<< return to previous page](#)

[Terms and Conditions](#) | [Privacy Statement](#) | © 2010 PPL Corporation

Before the
Pennsylvania Public Utility Commission

**Attachments to the Application
for
Eminent Domain Across Property
of**

Ronald & Dianne Mace

Application Docket No. _____

Submitted by: PPL Electric Utilities Corporation

**APPLICATION FOR EMINENT DOMAIN ACROSS PROPERTY OF
RONALD & DIANNE MACE**

TABLE OF CONTENTS

| <u>TOPIC</u> | <u>ATTACHMENT</u> |
|---|--------------------------|
| NECESSITY STATEMENT | 1 |
| STUDY AREA ENVIRONMENT | 2 |
| SITING ANALYSIS | 3 |
| IMPACT ASSESSMENT SCORING | 4 |
| LEGAL DESCRIPTION OF PROPERTY | 5 |
| LEGAL DESCRIPTION OF THE RIGHTS-OF-WAY TO BE CONDEMNED | 6 |
| MAP SHOWING THE LOCATION OF THE RIGHTS-OF-WAY TO BE ACQUIRED | 7 |
| PPL ELECTRIC UTILITIES CORPORATION'S BOARD OF DIRECTORS RESOLUTION | 8 |
| PPL ELECTRIC MAGNETIC FIELD MANAGEMENT | 9 |
| PPL ELECTRIC DESIGN CRITERIA & SAFTEY PRACTICES | 10 |

Attachment 1

**ATTACHMENT 1
RICHFIELD-DALMATIA 69 kV TIE LINE
NECESSITY STATEMENT**

TABLE OF CONTENTS

| <u>Section</u> | <u>Topic</u> | <u>Page</u> |
|-----------------------|---|--------------------|
| I. | INTRODUCTION | 1 |
| II. | SYSTEM PLANNING PROCESS AND GUIDELINES | 1 |
| III. | EXISTING SUB-TRANSMISSION SUPPLY SYSTEM | 3 |
| IV. | DEFINITION OF THE PROBLEM | 4 |
| V. | PROPOSED SYSTEM | 6 |
| VI. | ALTERNATIVES CONSIDERED | 7 |

LIST OF FIGURES/TABLES

| | | |
|----------|---|----|
| FIGURE 1 | FUNCTIONAL ONE-LINE DIAGRAM OF EXISTING TRANSMISSION SYSTEM CONFIGURATION | 10 |
| FIGURE 2 | FUNCTIONAL ONE-LINE DIAGRAM OF PROPOSED TRANSMISSION SYSTEM CONFIGURATION | 11 |
| FIGURE 3 | FUNCTIONAL ONE-LINE DIAGRAM OF EXISTING DISTRIBUTION SYSTEM CONFIGURATION | 12 |
| FIGURE 4 | FUNCTIONAL ONE-LINE DIAGRAM OF PROPOSED DISTRIBUTION SYSTEM CONFIGURATION | 13 |

MAP

PPL ELECTRIC SYSTEM MAP

ATTACHMENT 1
MAP POCKET

**ATTACHMENT 1
RICHFIELD - DALMATIA 69 kV TIE LINE
NECESSITY STATEMENT**

I. INTRODUCTION

PPL Electric Utilities Corporation (“PPL Electric”) proposes to construct a new single circuit 69 kV transmission tie line, approximately 11.5 miles in length, a 69-12 kV substation, and a transmission tap to the substation. The new tie line will be connected to PPL Electric’s existing Juniata-Richfield and Sunbury-Dauphin 69 kV transmission lines. The transmission tie line will be designed and constructed for 69 kV double circuit operation, however, initially only one circuit will be installed. The new tie line will supply the electrical power for the proposed Meiserville 69-12 kV Substation. This project is required to maintain reliable electric service to customers in portions of Northumberland, Snyder, and Juniata counties.

A PPL system map showing the existing transmission line facilities with a design voltage of 35 kV or greater is included as Map 1 in the Attachment 1 map pocket.

The estimated cost to design and construct this project is \$12 million including the cost to acquire rights-of-way. Construction is scheduled to begin in November of 2011 to meet a required in-service date of November 2012.

II. SYSTEM PLANNING PROCESS AND GUIDELINES

System Planning is the process which assures that PPL Electric’s regional transmission system can supply electricity to all customer load on a reliable and economic basis. This process assures that PPL Electric’s regional transmission system is planned and constructed so that:

- It can sustain probable contingencies and disturbances with minimal customer service interruption; and

- It can adequately serve each customer's needs with regard to capacity, voltage and reliability for all load levels throughout the daily load cycle.
- It accomplishes these goals by following the applicable guidelines in PPL Electric's Reliability Principles and Practices ("RP&P").

The reliable and economical operation of PPL Electric's 69 kV transmission system requires planning guidelines for system expansion. The planning guidelines in the RP&P are based on the following principles:

- System expansion should be coordinated to achieve an economical balance between construction and operating expenditures;
- System expansion should maintain a proper balance between degree of risk, amount and type of load interrupted, and the cost of providing the needed expansion; and
- System reliability should be maintained to prevent large scale, long term, or frequent service interruptions, in order to avoid adverse effects and hazards to the public.

In accordance with these planning guidelines, PPL Electric's regional transmission system is planned so that:

1. Normal operation of the system will not load any electric facility beyond its normal continuous rating.
2. The loss of any single transmission line, generating unit connected to the regional transmission system, power transformer, substation bus, circuit breaker, or double circuit line outage does not result in any system electric facility being operated beyond its applicable emergency rating.
3. No customer load is interrupted for routine maintenance of regional transmission facilities.
4. The loss of any single facility should not result in a voltage drop of more than 5% on the 69kV transmission system.
5. Stability of the electric system should be maintained from a permanent three-phase transmission line fault cleared by normal primary relay action. In addition, system stability should be maintained for a permanent single phase to ground line fault and

the failure of the protective devices to operate properly resulting in a failed circuit breaker.

6. There will be no large-scale, long term or frequent interruptions, or excessive load loss because of the adverse effects on, and hazard to, the public when such an event occurs.

The planning process begins with the development of a computer model of the future system. A specific study year is chosen, and the future system model is developed using the existing system plus any planned modifications to the transmission system. Included modifications are those scheduled to be in service prior to the study year or removed from service by that time. Load levels used in the system model are based on the latest forecast, which is prepared annually by the PJM Load Analysis Subcommittee. The forecast is based on recent summer peak loads, and on normal and high temperature and humidity indices.

Once the system model is complete, comprehensive power flow simulations are performed to determine the ability of the system to comply with the PPL Electric RP&P. This is accomplished by simulating an outage of each regional transmission and bulk electric facility. All conditions where the system is not in conformance with the reliability criteria are identified, and system reinforcements are added to the model to bring the system into conformance. Also identified are estimated costs and lead-times to implement the required reinforcements. Computer simulations of the system with the identified reinforcement alternatives are completed to identify the best overall reinforcement to meet the demand of the region in a reliable and economic manner.

III. EXISTING SYSTEM

The transmission facilities of concern identified in the planning process are PPL Electric's Juniata and Sunbury 230-69 kV Substations. Figure 1 shows the existing transmission system configuration in this area.

PPL Electric's Juniata 230-69 kV Substation supplies power to the Juniata-Richfield 69 kV Line. The Juniata-Richfield 69 kV Line serves the following six distribution substations: Benvenue, Thompsontown, Mifflintown, Walker, McAllisterville, and Richfield.

PPL Electric's Sunbury 230-69 kV Substation supplies power to the Sunbury-Dauphin 69 kV Line. The Sunbury-Dauphin 69 kV Line serves the following five distribution substations: Dalmatia, Elizabethville, Gratz, Lykens, and Williamstown.

The distribution facilities of concern identified in the planning process are the Dalmatia 69-12 kV Substation and the substation's associated Dalmatia 36-02 12 kV distribution line. The Dalmatia 36-02 distribution line, which starts out east of the Susquehanna River and crosses to the west side of the River, supplies 194 circuit miles across seven townships and a borough. The circuit serves over 2,200 customers in Northumberland, Snyder, and Juniata counties. See Figure 3 for the existing distribution system configuration in this area.

IV. DEFINITION OF THE PROBLEM

This project is required to improve reliability on both PPL Electric's transmission and distribution systems to adhere to PPL Electric's RP&P.

By the summer of 2012, an outage on the Juniata-Richfield 69 kV line due to the transmission line failure (failure of cross arms, insulators, line structures, wires down, etc.) or maintenance outage, would cause approximately 44 MW of load to remain interrupted after all field switches to transfer load to adjacent lines have been complete. If an outage were encountered under 2012 summer peak conditions on the Sunbury – Dauphin 69kV transmission line due to a line failure, approximately 33 MW of load would remain interrupted after all field switches are complete.

In both cases excessive load, beyond that permitted by the RP&P guidelines, would remain interrupted. The interruptions would remain until repairs are completed or additional reinforcements are provided.

The RP&P guidelines apply the following load interruption standards to an outage of a single circuit 69 kV transmission line:

- 60 MW of load can be interrupted for up to 2 hours, after 2 hours 30 MW of load must be restored by field switches to adjacent transmission lines; and
- After the earlier of 10 hours or repairs are completed, all load must be restored.

This proposed project will bring PPL Electric's transmission facilities into compliance with the RP&P guidelines, and provide transmission facilities for quick restoration of electric service. The project will resolve the load loss concerns associated with an outage on these lines.

In addition to meeting transmission standards, this project is required to provide electric power supply to the proposed Meiserville 69-12 kV Substation. The new substation is needed to alleviate electric service reliability concerns at the distribution level.

The Dalmatia 36-02 12 kV distribution line currently does not meet PPL Electric's RP&P guidelines for customer count per feeder, and for circuit miles supplied. The RP&P provides that no more than 1,300 customers should be served from a 12 kV circuit. In addition, the RP&P provides that a 12 kV circuit should not supply more than 50 miles of circuits. Prior to 2009, the Dalmatia Substation had one 12 kV distribution feeder, the Dalmatia 36-02. This 12 kV distribution line served over 3,000 customers with approximately 250 miles of circuits. In 2009 the line was split by adding a second 12 kV distribution line at the Dalmatia 69-12 kV Substation. Since the split, the new Dalmatia 36-02 12 kV distribution line serves over 2,200 customers and supplies 194 miles of circuits. The rural nature of the area, length of the circuit, and high number of customers on the circuit result in a large number of customers experiencing multiple outages per

year. The combination of these factors has led to the Dalmatia 36-02 distribution line being among the worst performing circuits on PPL Electric's system.

This project is required to meet distribution reliability standards and will ensure that PPL Electric can provide reliable electric service to customers in this area.

V. PROPOSED SYSTEM

In order to resolve the problem discussed above, PPL Electric plans to construct the Richfield-Dalmatia 69 kV Tie Line and the Meiserville 69-12 kV Substation. The proposed transmission tie line will provide additional transmission capacity and load transfer capability to restore loads on the Juniata – Richfield and Sunbury – Dauphin lines to meet the RP&P load drop standards for a single circuit 69 kV transmission line outage.

The proposed transmission line will utilize high-capacity 556.5 KCMIL¹ ACSR² conductors to provide sufficient capacity for load transfers between the Juniata – Richfield and the Sunbury – Dauphin 69kV lines under various line outage scenarios. The new transmission tie line will allow all load lost during an outage to be restored within the RP&P guidelines.

The new transmission tie line will also supply the new Meiserville 69-12 kV Substation. The Meiserville 69-12 kV Substation will be centrally located to the load it will serve, which will enhance the distribution reliability and operating flexibility in this area. Two new 12 kV distribution lines will be supplied from the new substation to serve customer load in the area. The new 12 kV distribution lines will serve part of the load currently being supplied by the Dalmatia 36-02 distribution line. This reinforcement will reduce the customer count per feeder and circuit miles of the existing Dalmatia 36-02 distribution line, thereby reducing the amount of exposure per line.

¹ Thousands of circular mils.

² Strand aluminum conductor steel reinforced.

See Figure 2 for the proposed transmission system configuration and Figure 4 for the proposed distribution system configuration.

VI. ALTERNATIVES CONSIDERED

Two alternatives for reinforcement of facilities in Northumberland, Snyder, and Juniata Counties were considered. Each alternative was considered based on its ability to add the required capacity to restore load on the Juniata-Richfield and the Sunbury-Dauphin 69kV lines under the various line outage conditions, and to do so in accordance with the RP&P guidelines. In addition, the alternatives had to provide a long-range solution that was economic and environmentally acceptable. The following two alternatives were considered.

Alternative 1 - Construct approximately 11 miles of 69kV tie line between PPL Electric's Juniata – Richfield and Sunbury-Dauphin 69 kV Transmission Lines (Preferred Option).

Alternative 1 involves the construction of a new double circuit 69 kV transmission line that would be approximately 11 miles in length, initially only one circuit would be installed. The proposed transmission line would extend from the area near PPL Electric's Richfield Substation to the area near the Dalmatia Substation, tying together the existing Juniata – Richfield and Sunbury – Dauphin 69 kV transmission lines.

The transmission line will be constructed with 556.5 KCMIL ACSR conductors to provide a high capacity regional transmission tie line between the Juniata – Richfield and the Sunbury – Dauphin 69 kV lines in the vicinity of the Richfield and the Dalmatia substations.

The estimated cost to design and construct Alternative 1 is \$12 million. This includes the cost to acquire rights-of-way.

Alternative 1 resolves load restoration capacity concerns and contributes to the long-term development of the 69 kV regional transmission system in this area by establishing a high capacity tie line between the Juniata-Richfield and the Sunbury-Dauphin 69 kV transmission lines.

This alternative does not require extensive outages of existing facilities for the construction of the new transmission line, thus maintaining reliable supply to customers in this area. It also would not require modifications to existing substations. In addition, it would also be able to supply power to the proposed Meiserville 69-12 kV Substation.

Alternative 2 - Construct approximately 15 miles of 69 kV transmission line from the Richfield Tie point on the Sunbury – Middletown 69 kV line to Sunbury Substation yard 2 and construct approximately 5 miles of 69 kV transmission line to connect the proposed Meiserville 69/12kV Substation.

Alternative 2 involves the construction of a new double circuit 69 kV transmission line utilizing 556.5 KCMIL ACSR conductors, to connect the Richfield Tie point on the Sunbury - Middleburg line to the Sunbury Substation 69 kV yard 2. The new transmission line would be approximately 15 miles in length. This configuration would require the installation of a new single breaker 69 kV termination in the Sunbury 69 kV yard 2.

The Sunbury – Middleburg 69 kV line ties into the Juniata-Richfield 69 kV transmission line. During summer peak conditions, this configuration results in an overload when the Sunbury-Middleburg line has to supply the Juniata – Richfield 69 kV transmission line. The overload is due to the fact that a significant amount of load (Beavertown/Middleburg/Penn/Selinsgrove) is connected to the Sunbury-Richfield 69 kV line, and therefore, it has no additional capacity to restore Juniata-Richfield transmission line load. The proposed line would require a new 69 kV substation termination at the existing Sunbury Substation 69 kV yard 2 to provide back up supply source to the

Juniata-Richfield load. In addition to this, a new transmission line approximately 5 miles long will be required to supply power to the Meiserville 69-12kV substation.

Alternative 2 is estimated to cost \$22 million.

Alternative 2 resolves the load restoration to the Juniata-Richfield line by providing an additional power source to the region supplied by the Sunbury 230-69 kV Substation. However, Alternative 2 is less economical, would require more construction lead-time, and encumbers more land because of the longer length of the new transmission lines. The lead-time needed to acquire the necessary rights-of-way, and construction of the lines, would be significantly longer than Alternative 1. Using the Sunbury Substation also requires a new termination at the Sunbury 69 kV yard 2, which is very congested. This may require rearrangement of the 69 kV yard 2, which would come at an additional cost that is not included in the estimate. In addition, this option does not provide back-up support to the Sunbury-Dauphin 69 kV line and still requires a supply line to the proposed Meiserville substation across the Susquehanna River.

For the reasons cited above, Alternative 1 was determined to be the preferred option and Alternative 2 was eliminated.

Conclusion:

Based upon the analysis summarized above, PPL Electric has determined that Alternative 1 is the best alternative for addressing the problems identified in Section IV, above.

FUNCTIONAL ONE-LINE DIAGRAM
EXISTING TRANSMISSION SYSTEM

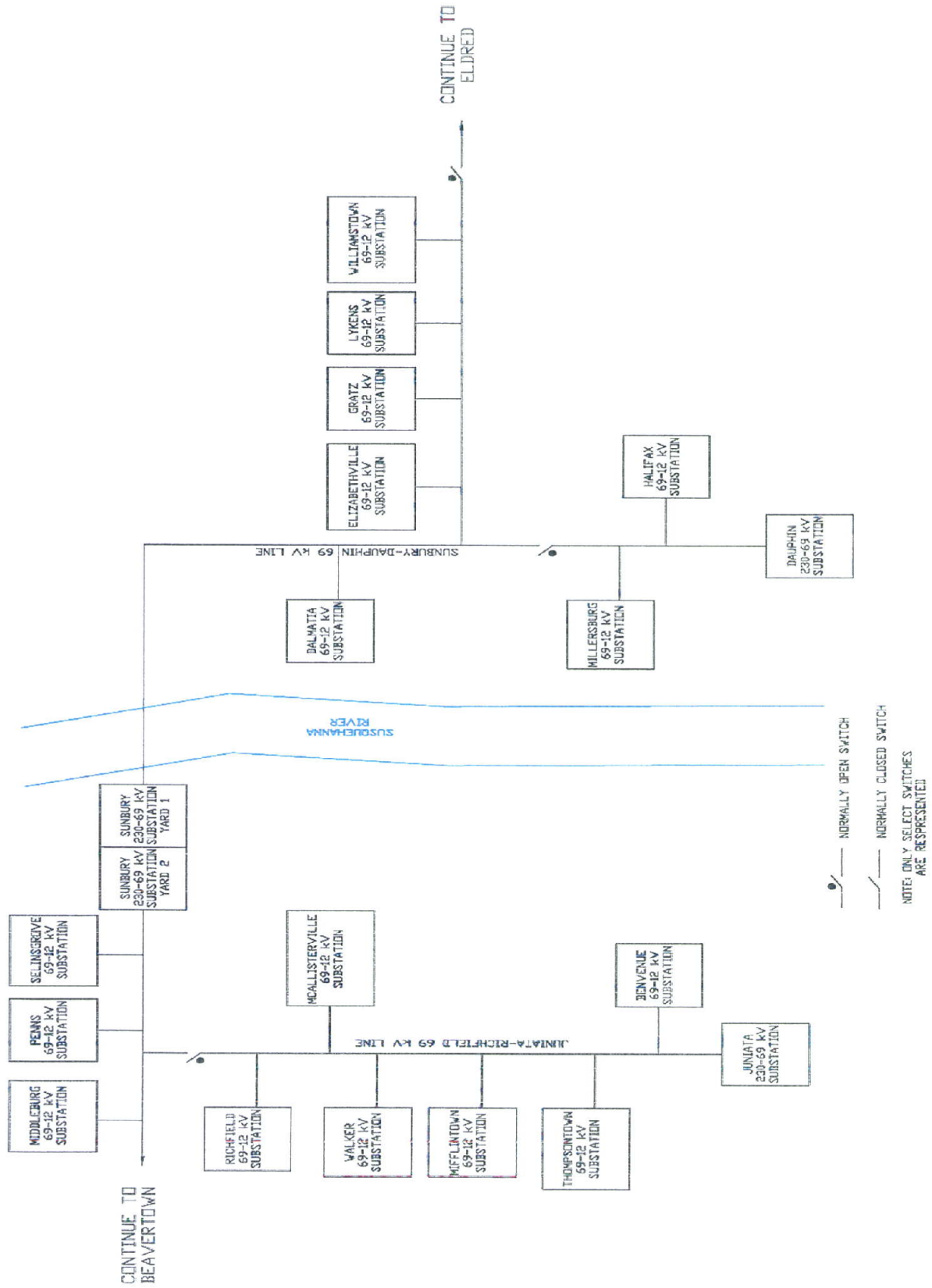

FIGURE 1

FUNCTIONAL ONE-LINE DIAGRAM
PROPOSED TRANSMISSION SYSTEM

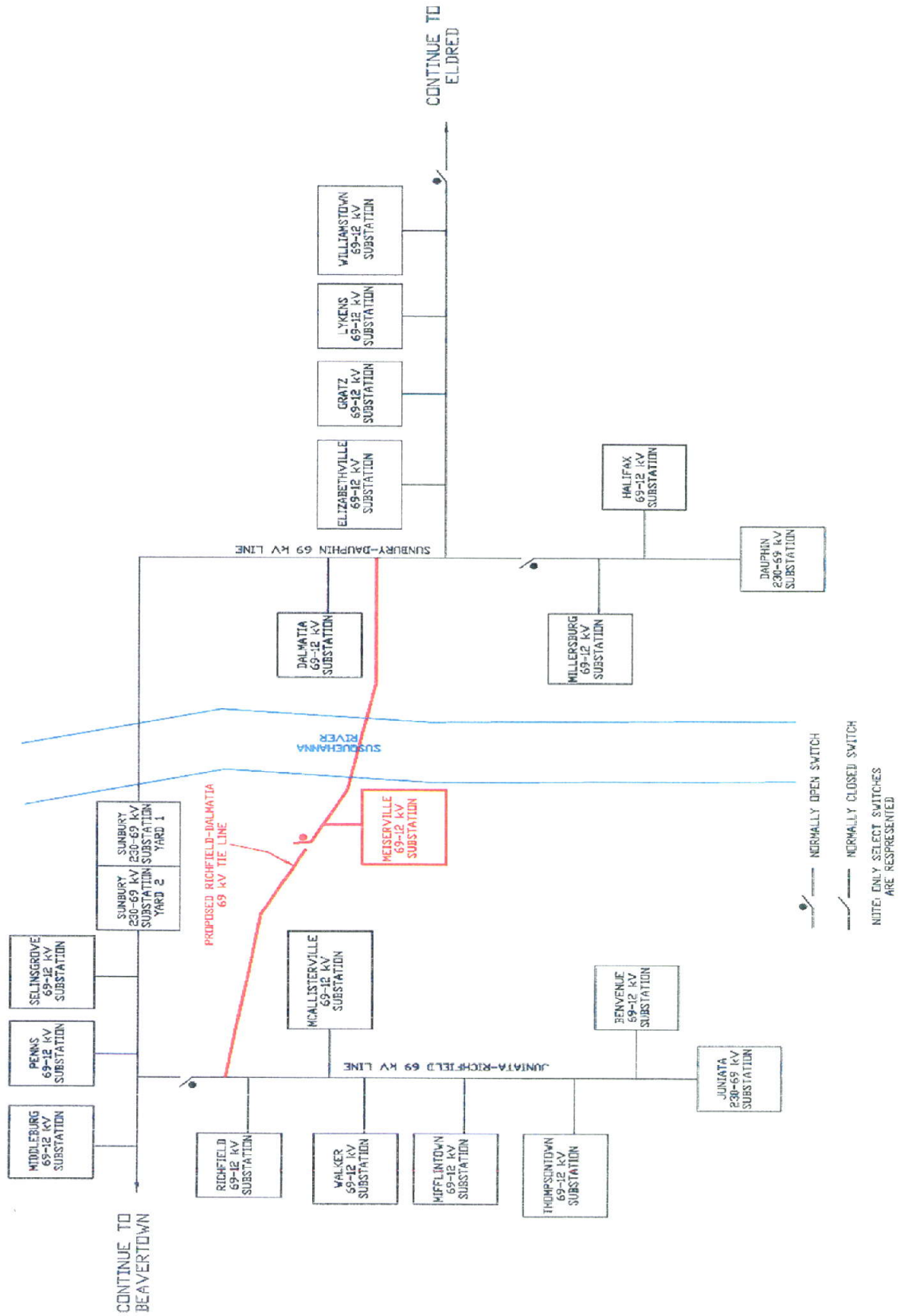

FIGURE 2

FUNCTIONAL ONE-LINE DIAGRAM
PROPOSED DISTRIBUTION SYSTEM

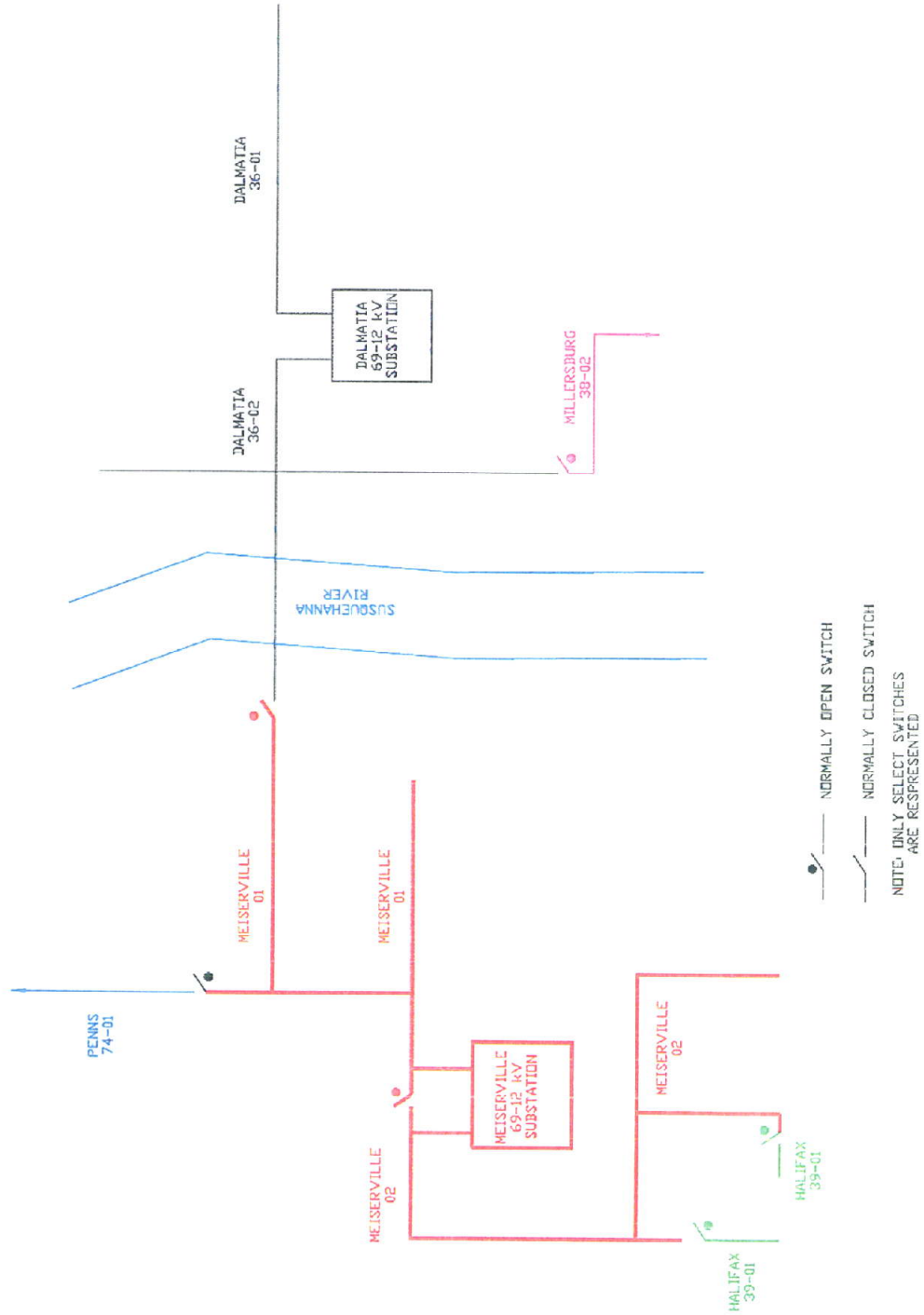
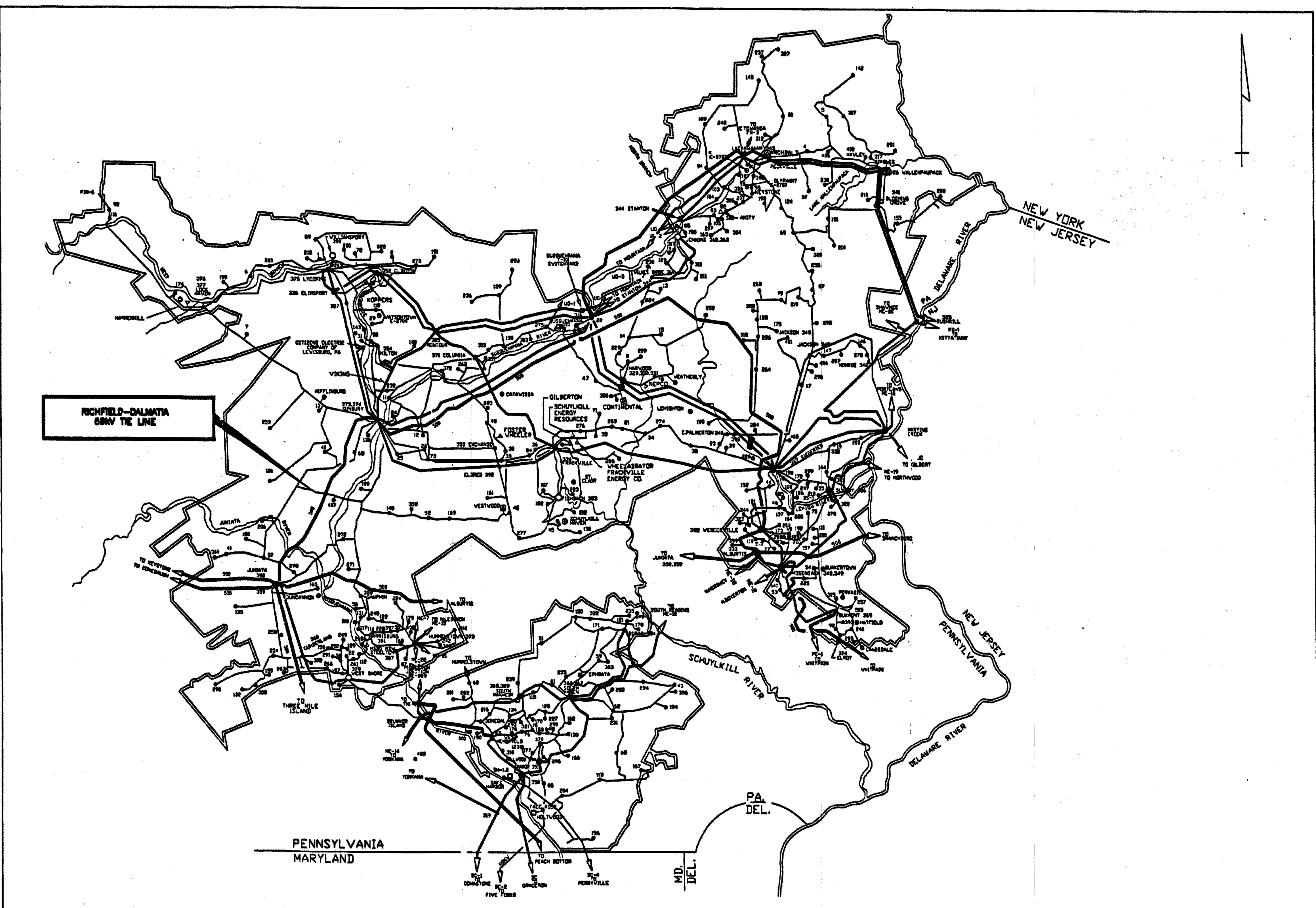

FIGURE 4

SUBSTATION LISTING

| | | | | | |
|-----|--------------------|-----|-------------------|-----|--------------------------|
| 1 | WEST WILLIAMSPORT | 151 | CRACKERSPORT | 201 | CENTER CITY |
| 2 | FAIRFIELD | 152 | SCHNECKSVILLE | 202 | NEW KINGSTOWN |
| 3 | MONTGOMERY | 153 | MEMLOCK | 203 | REAMSTOWN |
| 4 | VARDEN | 154 | MT. ALLEN | 204 | DUPONT |
| 5 | MENSALE | 155 | LAKEVIEW | 205 | MICHEL BT |
| 6 | JERSEY SHORE | 156 | COOPERSBURG | 206 | CEDAR AVE |
| 7 | LOGANTON | 157 | WYOMING | 207 | INDIAN ORCHARD |
| 8 | VAL MONT | 158 | WEST CARLSLE | 208 | NOTTINGHAM |
| 9 | RIVER | 159 | BENVENUE | 209 | NORTH COOLBAUGH |
| 10 | LIMESTONE | 160 | REGINA | 210 | LEIGHT |
| 11 | REDFRUIT | 161 | YATESVILLE | 211 | EAST MOUNTAIN |
| 12 | WRIGHT | 162 | CENTRAL ALLENTOWN | 212 | JERMYN |
| 13 | ST. JOHNS | 163 | DEER LN | 213 | BLOOMSBURG |
| 14 | REGLAND | 164 | STRASBURG | 214 | HIFLINTOWN |
| 15 | GILBERT | 165 | ATGLEN | 215 | RIDGE ROAD |
| 16 | CHERRY HILL | 166 | BROOKSIDE | 216 | SUSQUEHANNA |
| 17 | SUSQUEHANNA 230KV | 167 | VILLIAMSTOWN | 217 | T-10 SV. YD. |
| 18 | TAMMEND | 168 | E. PETERSBURG | 218 | KIMBLE |
| 19 | WHITE HILL | 169 | VERMILION | 219 | CHRISTMAS |
| 20 | PALMERTON | 170 | N. BETHLEHEM | 220 | OTTIE CREEK |
| 21 | HAMILTON | 171 | V. ALLENTOWN | 221 | ST. CITY |
| 22 | HUNTER | 172 | FLEMINGTON | 222 | MCQUEENVILLE |
| 23 | FAIRVIEW | 173 | NECKERSVILLE | 223 | ROBESONIA |
| 24 | MONTOUR PUMP | 174 | MILLERSVILLE | 224 | SFCSELSVILLE |
| 25 | MT. CARMEL | 175 | SHILLINGTON | 225 | ELROY |
| 26 | SPORTING HILL | 176 | MCALLISTERVILLE | 226 | BUSHMILL |
| 27 | MAHANDY CITY | 177 | MARLIN | 227 | WALLENPAUPACK |
| 28 | GREENWOOD | 178 | WEST BERWICK | 228 | ELK MOUNTAIN |
| 29 | MOVYR | 179 | GREEN AVENUE | 229 | JACK FRDST |
| 30 | ALTAHOUNT | 180 | MICKLEYS | 230 | HARWOOD 230/69KV |
| 31 | HANE RIDGE | 181 | EAST ALLENTOWN | 231 | HARWOOD CTG |
| 32 | ASHFIELD | 182 | DALE | 232 | NAZARETH |
| 33 | SOUTH SLATINGTON | 183 | PENNSBORO | 233 | ALBARTIS |
| 34 | SOUTH MIDDLEBURG | 184 | NORTH COLUMBIA | 234 | CRACKVILLE |
| 35 | WALKER | 185 | WHELESVILLE | 235 | ALLENWOOD |
| 36 | FRATLEY | 186 | SOUTH ALLENTOWN | 236 | GRATZ |
| 37 | MORGANTOWN | 187 | WEISSPORT | 237 | HOCKERSVILLE |
| 38 | MORGANTOWN | 188 | MOORE BROOK | 238 | BLDGMING GROVE |
| 39 | CRESSONA | 189 | MOSCOV | 239 | MJNRDE |
| 40 | SOUTH WHITEHALL | 190 | ROSSSHOYE | 240 | LACAVANNA #1 |
| 41 | EAST TOMHICKEN | 191 | NORTHAMPTON | 241 | STANTON |
| 42 | BEAR GAP | 192 | WOODRICH | 242 | JACKSON |
| 43 | SALISBURY | 193 | FAVON | 243 | EAST PALMERTON |
| 44 | HEIDELBERG | 194 | ELIZABETHTOWN | 244 | SIEGFRIED |
| 45 | LYKEN | 195 | END A | 245 | HOSENSACK 230/69KV |
| 46 | UPPER HANOVER | 196 | TECK | 246 | HOSENSACK 500KV |
| 47 | RICH AND | 197 | MT. BETHEL | 247 | CONESTOGA |
| 48 | MADADA | 198 | ROCKFEL | 248 | MILTON |
| 49 | ROCKFEL | 199 | THORNTON | 249 | CLINTON |
| 50 | PAXTON | 200 | TWIN LAKES | 250 | EXCHANGE |
| 51 | COCALICO | 201 | HARLEIGH | 251 | MILTON |
| 52 | EAST ELIZABETHTOWN | 202 | MILTON | 252 | DAUPHIN |
| 53 | WARWICK | 203 | BEAR CREEK | 253 | QUARRY SUB. |
| 54 | HEMPFIELD | 204 | DRYBROOK | 254 | STEELTON |
| 55 | EAST LANCASTER | 205 | CANDEWIS | 255 | JUNIATA 500/230KV |
| 56 | KINZER | 206 | LINDEN | 256 | JUNIATA 230/69KV |
| 57 | MT. PLENO | 207 | WEST JOY | 257 | CUMBERLAND |
| 58 | MT. PLENO | 208 | WEST BLOOMSBURG | 258 | DONEGAL |
| 59 | PENNS | 209 | MINSI TRAIL | 259 | JENKINS 230/69KV |
| 60 | GOLDSBORO | 210 | LAKE NAOMI | 260 | JENKINS CTG |
| 61 | MILLENVILLE | 211 | LANARK | 261 | WILKES-BARRE |
| 62 | GIRARD HANOR | 212 | LAKE NAOMI | 262 | BUXMONT |
| 63 | KENMAR | 213 | LAKE NAOMI | 263 | SOUTH AKRON 230/138/69KV |
| 64 | GOVEN CITY | 214 | LAKE NAOMI | 264 | SOUTH AKRON 69/12KV |
| 65 | ELLIOT HEIGHTS | 215 | LAKE NAOMI | 265 | SOUTH MANHEIM 69/12KV |
| 66 | ROCHERESTOWN | 216 | LAKE NAOMI | 266 | SOUTH MANHEIM 230/69KV |
| 67 | MAGNIFICENT | 217 | LAKE NAOMI | 267 | ENGLISIE |
| 68 | EAST MAZLETON | 218 | LAKE NAOMI | 268 | COLUMBIA |
| 69 | WAGNER | 219 | LAKE NAOMI | 269 | DANVILLE |
| 70 | EAST CARBONDALE | 220 | LAKE NAOMI | 270 | SUNBURY |
| 71 | LYNDEN | 221 | LAKE NAOMI | 271 | HUMMELS VHAF |
| 72 | HINDOKA | 222 | LAKE NAOMI | 272 | LYCOMING |
| 73 | D.D. FORGE | 223 | LAKE NAOMI | 273 | LOCK HAVEN CTG |
| 74 | FOUNTAIN SPRINGS | 224 | LAKE NAOMI | 274 | LOCK HAVEN 69/12KV |
| 75 | SULLIVAN TRAIL | 225 | LAKE NAOMI | 275 | KUMMELSTOWN |
| 76 | SWATARA | 226 | LAKE NAOMI | 276 | WEST SHORE |
| 77 | HEPBURN | 227 | LAKE NAOMI | 277 | MONTAGE |
| 78 | HEPBURN | 228 | LAKE NAOMI | 278 | SOUTH FARMERSVILLE |
| 79 | FRANCONIA | 229 | LAKE NAOMI | 279 | VEESDORF |
| 80 | EMMAUS | 230 | LAKE NAOMI | 280 | FISHBACH |
| 81 | MORGAN | 231 | LAKE NAOMI | 281 | BERKS |
| 82 | THROOP | 232 | LAKE NAOMI | 282 | MONTOUR |
| 83 | THROOP | 233 | LAKE NAOMI | 283 | SUBURBAN YARD |
| 84 | CHAPMAN | 234 | LAKE NAOMI | 284 | EDLA |
| 85 | SUBURBAN | 235 | LAKE NAOMI | 285 | EDLA |
| 86 | SUBURBAN | 236 | LAKE NAOMI | 286 | DORNEVILLE |
| 87 | SUBURBAN | 237 | LAKE NAOMI | 287 | BOHEMIA |
| 88 | SUBURBAN | 238 | LAKE NAOMI | 288 | WHITE HAVEN |
| 89 | SUBURBAN | 239 | LAKE NAOMI | 289 | LAURELTON |
| 90 | SUBURBAN | 240 | LAKE NAOMI | 290 | ELDRED |
| 91 | SUBURBAN | 241 | LAKE NAOMI | 291 | ELDRED |
| 92 | SUBURBAN | 242 | LAKE NAOMI | 292 | ELDRED |
| 93 | SUBURBAN | 243 | LAKE NAOMI | 293 | ELDRED |
| 94 | SUBURBAN | 244 | LAKE NAOMI | 294 | ELDRED |
| 95 | SUBURBAN | 245 | LAKE NAOMI | 295 | ELDRED |
| 96 | SUBURBAN | 246 | LAKE NAOMI | 296 | ELDRED |
| 97 | SUBURBAN | 247 | LAKE NAOMI | 297 | ELDRED |
| 98 | SUBURBAN | 248 | LAKE NAOMI | 298 | ELDRED |
| 99 | SUBURBAN | 249 | LAKE NAOMI | 299 | ELDRED |
| 100 | SUBURBAN | 250 | LAKE NAOMI | 300 | ELDRED |
| 101 | SUBURBAN | 251 | LAKE NAOMI | 301 | ELDRED |
| 102 | SUBURBAN | 252 | LAKE NAOMI | 302 | ELDRED |
| 103 | SUBURBAN | 253 | LAKE NAOMI | 303 | ELDRED |
| 104 | SUBURBAN | 254 | LAKE NAOMI | 304 | ELDRED |
| 105 | SUBURBAN | 255 | LAKE NAOMI | 305 | ELDRED |
| 106 | SUBURBAN | 256 | LAKE NAOMI | 306 | ELDRED |
| 107 | SUBURBAN | 257 | LAKE NAOMI | 307 | ELDRED |
| 108 | SUBURBAN | 258 | LAKE NAOMI | 308 | ELDRED |
| 109 | SUBURBAN | 259 | LAKE NAOMI | 309 | ELDRED |
| 110 | SUBURBAN | 260 | LAKE NAOMI | 310 | ELDRED |
| 111 | SUBURBAN | 261 | LAKE NAOMI | 311 | ELDRED |
| 112 | SUBURBAN | 262 | LAKE NAOMI | 312 | ELDRED |
| 113 | SUBURBAN | 263 | LAKE NAOMI | 313 | ELDRED |
| 114 | SUBURBAN | 264 | LAKE NAOMI | 314 | ELDRED |
| 115 | SUBURBAN | 265 | LAKE NAOMI | 315 | ELDRED |
| 116 | SUBURBAN | 266 | LAKE NAOMI | 316 | ELDRED |
| 117 | SUBURBAN | 267 | LAKE NAOMI | 317 | ELDRED |
| 118 | SUBURBAN | 268 | LAKE NAOMI | 318 | ELDRED |
| 119 | SUBURBAN | 269 | LAKE NAOMI | 319 | ELDRED |
| 120 | SUBURBAN | 270 | LAKE NAOMI | 320 | ELDRED |
| 121 | SUBURBAN | 271 | LAKE NAOMI | 321 | ELDRED |
| 122 | SUBURBAN | 272 | LAKE NAOMI | 322 | ELDRED |
| 123 | SUBURBAN | 273 | LAKE NAOMI | 323 | ELDRED |
| 124 | SUBURBAN | 274 | LAKE NAOMI | 324 | ELDRED |
| 125 | SUBURBAN | 275 | LAKE NAOMI | 325 | ELDRED |
| 126 | SUBURBAN | 276 | LAKE NAOMI | 326 | ELDRED |
| 127 | SUBURBAN | 277 | LAKE NAOMI | 327 | ELDRED |
| 128 | SUBURBAN | 278 | LAKE NAOMI | 328 | ELDRED |
| 129 | SUBURBAN | 279 | LAKE NAOMI | 329 | ELDRED |
| 130 | SUBURBAN | 280 | LAKE NAOMI | 330 | ELDRED |
| 131 | SUBURBAN | 281 | LAKE NAOMI | 331 | ELDRED |
| 132 | SUBURBAN | 282 | LAKE NAOMI | 332 | ELDRED |
| 133 | SUBURBAN | 283 | LAKE NAOMI | 333 | ELDRED |
| 134 | SUBURBAN | 284 | LAKE NAOMI | 334 | ELDRED |
| 135 | SUBURBAN | 285 | LAKE NAOMI | 335 | ELDRED |
| 136 | SUBURBAN | 286 | LAKE NAOMI | 336 | ELDRED |
| 137 | SUBURBAN | 287 | LAKE NAOMI | 337 | ELDRED |
| 138 | SUBURBAN | 288 | LAKE NAOMI | 338 | ELDRED |
| 139 | SUBURBAN | 289 | LAKE NAOMI | 339 | ELDRED |
| 140 | SUBURBAN | 290 | LAKE NAOMI | 340 | ELDRED |
| 141 | SUBURBAN | 291 | LAKE NAOMI | 341 | ELDRED |
| 142 | SUBURBAN | 292 | LAKE NAOMI | 342 | ELDRED |
| 143 | SUBURBAN | 293 | LAKE NAOMI | 343 | ELDRED |
| 144 | SUBURBAN | 294 | LAKE NAOMI | 344 | ELDRED |
| 145 | SUBURBAN | 295 | LAKE NAOMI | 345 | ELDRED |
| 146 | SUBURBAN | 296 | LAKE NAOMI | 346 | ELDRED |
| 147 | SUBURBAN | 297 | LAKE NAOMI | 347 | ELDRED |
| 148 | SUBURBAN | 298 | LAKE NAOMI | 348 | ELDRED |
| 149 | SUBURBAN | 299 | LAKE NAOMI | 349 | ELDRED |
| 150 | SUBURBAN | 300 | LAKE NAOMI | 350 | ELDRED |



**RICHFIELD-DALMATIA
69KV TIE LINE**

INTERCONNECTIONS

PS PUBLIC SERVICE ELECTRIC AND GAS CO. OF N.J.
 ME METROPOLITAN EDISON CO. (FIRST ENERGY)
 PE PHILADELPHIA ELECTRIC CO. (FRED ENERGY)
 BC BALTIMORE GAS AND ELECTRIC CO.
 SH SAFE HARBOR WATER POWER CORPORATION
 UP THE UNITED GAS IMPROVEMENT CO. - LUZERNE ELECTRIC DIVISION
 PH PENNSYLVANIA ELECTRIC CO. (FIRST ENERGY)
 JC JERSEY CENTRAL POWER AND LIGHT CO. (FIRST ENERGY)

- COMBUSTION TURBINE
- HYDRO ELECTRIC
- COMBINATION
- FIRM SALES
- SUBSTATION / SWITCHING STATION
- STEAM ELECTRIC
- NON-UTILITY GENERATION
- INDEPENDENT POWER PRODUCERS

- 500KV OPERATION
- 230KV OPERATION
- 138KV OPERATION
- 69KV OPERATION

| | | | |
|-----------------|---------------------------|-----------------------|------------------------|
| ACCT- 605201 | | ELECTRICAL SYSTEM MAP | |
| SCALE- NONE | | RICHFIELD - DALMATIA | |
| BY- CDW | | 69KV TIE LINE | |
| REVIEWED | APPROVED G. HARKUN III | DATE 7/17/85 | PPL ELECTRIC UTILITIES |
| PPL DRAWING NO. | SHEET NO. | REV. | |
| D191830 | | 1 | 73 |
| BY | REVIEWED | APPROVED | |
| | | | |
| #6000 | LOCATION CODES | PLAN & PROFILE NO. | TRANSMISSION MAP NO. |
| | | | |

| NO. | DATE | ACCT. | DESCRIPTION | BY | REVIEWED | APPROVED |
|-----|---------|--------|---|-----|----------|----------|
| 72 | 9/2/10 | 001465 | ADDED WEST SHORE-STEELTON 230KV TRANSMISSION LINE POLE REPLACEMENT. | RRC | | JW |
| 71 | 08/1/10 | 309371 | ADDED DAPPERS 69-12W SUBSTATION. | RRC | | DG |
| 70 | 8/10/10 | 169008 | ADDED BLUE MOUNTAIN #1 & #2 138W TAP | RWM | RWM | KBK |
| 73 | 9/17/10 | 169024 | ADDED RICHFIELD-DALMATIA 69KV TIE LINE & MEISERVILLE SUB. | RRC | | JW |

Attachment 2

**ATTACHMENT 2
 RICHFIELD-DALMATIA 69 kV TIE LINE
 STUDY AREA ENVIRONMENT**

TABLE OF CONTENTS

| <u>SECTION</u> | <u>TOPIC</u> | <u>PAGE</u> |
|-----------------------|--|--------------------|
| I. | INTRODUCTION..... | 1 |
| II. | STUDY AREA LOCATION AND DESCRIPTION..... | 1 |
| III. | DELINEATION OF STUDY AREA..... | 2 |
| IV. | ENVIRONMENTAL INVENTORY GUIDELINES..... | 3 |
| V. | ENVIRONMENTAL INVENTORY..... | 4 |
| A. | LINEAR FEATURES – MAP 1..... | 5 |
| | Electric Transmission Lines and Substations..... | 5 |
| | Highways and Roads..... | 6 |
| | Railroads..... | 7 |
| | Telecommunication Lines and Cellular Transmission Towers..... | 7 |
| B. | EXISTING LAND USE – MAP 2..... | 7 |
| | Existing Land Use..... | 9 |
| C. | MUNICIPAL ZONING AND SUDIVISION AND LAND DEVELOPMENT ORDINANCES..... | 11 |
| D. | AGRICULTURAL PRESERVATION – MAP 3..... | 12 |
| E. | SOIL CHARACTERISTICS – MAP 4..... | 13 |
| F. | STEEP SLOPES - MAP 5..... | 14 |
| G. | NATURAL FEATURES – MAP 6..... | 16 |
| | Woodlands and Natural Vegetation..... | 16 |
| | Surface Waters..... | 17 |
| | 100-Year Floodplains..... | 20 |
| | Wetlands..... | 20 |
| | Natural Heritage Sites..... | 21 |

| <u>SECTION</u> | <u>TOPIC</u> | <u>PAGE</u> |
|----------------|---|-------------|
| H. | GEOLOGY – MAP 7..... | 23 |
| I. | CULTURAL AND HISTORIC FEATURES – MAP 8..... | 25 |
| | Historic Sites..... | 25 |
| | Archaeological Sites..... | 27 |

**ATTACHMENT 2
RICHFIELD-DALMATIA 69 kV TIE LINE
STUDY AREA ENVIRONMENT**

I. INTRODUCTION

This attachment provides an environmental inventory of the Richfield-Dalmatia 69 kV Tie Line Project Study Area. The information contained in this report was gathered from several sources, including Geographic Information Systems (“GIS”), field reconnaissance surveys, meetings and discussions with environmental specialists and planners, information supplied by public agencies, and appropriate publications. Although this line route does not require approval from the Pennsylvania Public Utility Commission (“Commission”), PPL Electric considered the Commission’s requirements in siting the line.

II. STUDY AREA LOCATION AND DESCRIPTION

The Study Area is located in Juniata, Snyder, and Northumberland Counties in Central Pennsylvania. The following municipalities are included in the Study Area, either in whole or in part:

- Monroe Township, Juniata County
- Susquehanna Township, Juniata County
- Chapman Township, Snyder County
- Perry Township, Snyder County
- West Perry Township, Snyder County
- Lower Mahanoy Township, Northumberland County

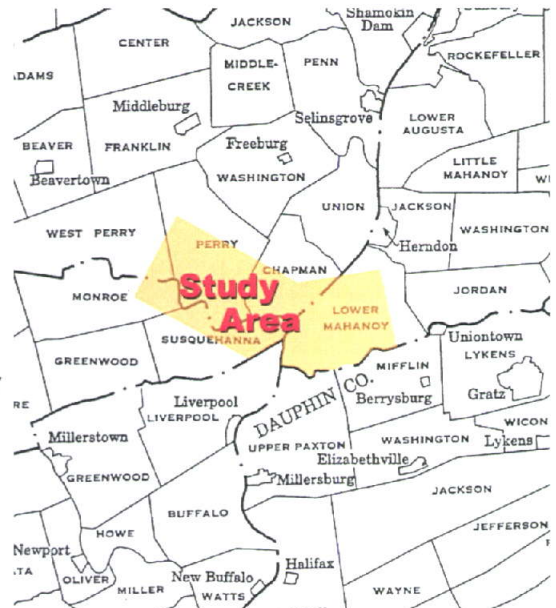

The Study Area contains a variety of natural features and human development patterns. The Susquehanna River separates Northumberland County on the east side of the river from Snyder and Juniata Counties on the west side of the river. Mountains and steep hills dominate the landscape. There are some broad, nearly level areas, especially along the western side of the Susquehanna River.

Much of the non-mountainous land in the Study Area is farmed. General farming predominates, but there are many specialized farms, including dairy farms. Small villages including Dalmatia and Hickory Corners are located in Lower Mahanoy Township. Located in Chapman Township are the hamlets of Independence, McKees Half Falls and Meiserville. The village of Mount Pleasant Mills and the hamlet of Aline are located in Perry Township.

The Study Area is 30 miles north of Harrisburg and 12 miles south of Shamokin Dam and Sunbury. Major roads include US Route 11/15 along the west shore of the Susquehanna River and PA Route 147 through Lower Mahanoy Township on the east side of the river. The Study Area is located in part of the Central Pennsylvania Appalachian Region.

III. DELINEATION OF THE STUDY AREA

PPL Electric conducted a detailed siting analysis to determine a location for the Richfield – Dalmatia 69 kV Tie Line that best balances social, environmental, engineering, and economic considerations. These studies included the determination of a Study Area, the compilation of an environmental inventory, identification and analysis of alternative line routes and finally, selection of the preferred transmission line route corridor.

The Study Area for the project is shown on Maps 1 through 8 included in this report. The Study Area is that territory in which line route alternatives can be sited to feasibly meet the project's functional requirements and, at the same time, minimize environmental impacts and project costs.

The boundaries of the Richfield-Dalmatia 69 kV Tie Line Project Study Area were determined by the potential supply and destination service points viewed with consideration for man-made and natural boundaries beyond which line route alternatives would not be reasonable.

The east and west boundaries of the Study Area are generally defined by the need to connect the existing Juniata-Richfield 69 kV Line in the West Perry and Monroe Township area (Snyder and Juniata Counties) to the existing Sunbury-Dauphin 69 kV Line located in Lower Mahanoy Township, Northumberland County. The northern and southern Study Area boundaries represent points beyond which it becomes impractical to site a new transmission line due to increased impacts. Functional requirements dictate the exact extent of the Study Area, which is between approximately 4.9 and 4.2 miles from north to south, is approximately 12 miles long east to west and is approximately 64.2 square miles in total land area. In addition, the functional requirements of the planned Meiserville 69-12 kV Substation influenced the extent of the Study Area.

The Study Area boundary described above is shown on every environmental inventory map associated with this project. However, all maps show a larger geographical area than the Study Area and therefore show features (and in some cases inventoried sites) *outside* that boundary.

IV. ENVIRONMENTAL INVENTORY GUIDELINES

An environmental inventory lists environmental factors considered when evaluating and selecting transmission line routes and substation sites. These factors can be either adversely affected by, or compatible with, transmission facilities.

Major environmental factors and the reasons why they are inventoried are listed in Appendix A - Environmental Inventory Guidelines.

V. ENVIRONMENTAL INVENTORY

This study used several levels of accurate, current geographic data to identify and record environmental data. The maps for the project Study Area were developed by digitally compiling the most recent United States Geologic Survey (“USGS”) 1:24,000 scale maps of the area, in conjunction with GIS data provided by the Northumberland County Planning Commission, Snyder County Planning Commission, Juniata County Planning Commission and Pennsylvania State University. GIS provides information-linked map data for nearly all of the natural, political, and cultural features mapped in this inventory. All of the above data was analyzed in a GIS program to provide the necessary graphic and informational results for this study. Finally, the resulting maps were checked and confirmed by field investigations and meetings with local officials. The environmental data collected include the following subjects:

- Linear Features (Map 1)
- Existing Land Use (Map 2)
- Agricultural Preservation (Map 3)
- Soil Characteristics (Map 4)
- Steep Slopes (Map 5)
- Natural Features (Map 6)
- Geology (Map 7)
- Cultural and Historic Features (Map 8)
- Existing Constraints

A. LINEAR FEATURES – MAP 1

Roadways, railroads, pipelines and transmission lines are examples of linear features. In many situations, it is desirable for a proposed transmission line to parallel existing linear features. This paralleling approach can eliminate the need for a new corridor and thereby reduce land use and environmental impacts. A new line creates only incremental impacts when added to an existing linear feature.

The following linear features, which are found within the Study Area, appear on all of the Environmental Inventory Maps:

ELECTRIC TRANSMISSION LINES AND SUBSTATIONS

Four existing transmission lines operated by PPL Electric traverse the Study Area. The names of the existing transmission lines are labeled on Maps 1 through 8 and are as follows:

PPL Transmission Lines:

- Juniata-Sunbury 500 kV Line (Snyder and Juniata Counties)
- Juniata-Richfield 69 kV Line (Snyder and Juniata Counties)
- Sunbury-Dauphin 69 kV Tap (Northumberland County)
- Dalmatia Tap 138/69 kV Line (Northumberland County)

In addition to transmission line facilities, the Dalmatia Substation is located just to the east of the village of Dalmatia. Electricity is furnished to the Dalmatia Substation through the Dalmatia 69 kV Tap, which connects with the Sunbury-Dauphin 69 kV Line farther to the east.

HIGHWAYS AND ROADS

The road network of the Study Area is comprised of a major four-lane arterial highway, three two-lane state routes, numerous rural roads and residential streets, and several unpaved roads. Significant roads include the following:

- **US Route 11/15**, a major north-south arterial road connecting Harrisburg and Shamokin Dam. Also known as the Susquehanna Trail, US Route 11/15 follows the west shore of the Susquehanna River for most of its course through the Study Area. US Route 11/15 consists of four undivided traffic lanes with a center turn lane. Small pockets of commercial development occur along US Route 11/15 between the villages of McKees Half Falls and Independence.
- **PA Route 35**, a two-lane state road. Route 35 is located in the northwest corner of the Study Area. Situated in Perry Township, Route 35 connects the village of Mount Pleasant Mills with the village of Richfield to the southwest.
- **PA Route 104**, originating at US Route 11/15 near the village of Liverpool. PA Route 104 is a winding two-lane road that trends in a northwest-southeast direction through Susquehanna Township, Chapman Township and Perry Township.
- **PA Route 147**, a two-lane road that winds its way through Lower Mahanoy Township in Northumberland County. PA Route 147 connects the northern Harrisburg area to the south with Sunbury to the north. PA Route 147 passes through the village of Dalmatia where it is named George Street.

RAILROADS

One active railroad exists within the Study Area. The Norfolk-Southern Railroad follows the east shore of the Susquehanna River through Lower Mahanoy Township, Northumberland County.

TELECOMMUNICATION LINES AND CELLULAR TRANSMISSION

TOWERS

In addition to standard telephone transmission lines elevated or buried along roadways, major telecommunication providers operate larger transmission cables in underground cross-country routes. One such line, operated by AT&T, is located in Lower Mahanoy Township.

Two cellular transmission towers are located within the Study Area. Both towers are located in Lower Mahanoy Township. One cellular tower is located on a high-point between the Susquehanna River and PA Route 147. The other cellular tower is located on Fisher Ridge to the south of Dalmatia and east of PA Route 147.

B. EXISTING LAND USE – MAP 2

Identifying land use is important in the siting of electric transmission lines and related facilities. Each type of land use activity varies in the significance of impact from a transmission line. Land uses are mapped to provide an understanding of the wide variety of land activities found in the Study Area and to evaluate the potential impact of a transmission line upon them.

Existing land use information in GIS data form was obtained from the Juniata County Planning Commission (“JCPC”), the Snyder County Planning Commission (“SCPC”), the Northumberland County Planning Commission (“NCPC”), and Pennsylvania Spatial Data Access (“PASDA”). The land use data from these different sources was used to create a common theme for the

generalized land use map. Field surveys were undertaken throughout the Study Area to verify and update land use designations. The land uses inventoried are described below.

- **Farmstead** – includes a building or a group of buildings that may contain a residence, barn, and accessory buildings associated with farming and agricultural uses.
- **Residential** – includes land used for single-family homes, townhomes, apartment complexes, and manufactured home parks.
- **Commercial** – includes shopping centers, restaurants, retail, wholesale, and service and /or related establishments, as well as office/professional parks.
- **Public/Semi-Public**– includes public and private schools, colleges, churches, cemeteries, assisted living facilities, government offices, police stations, fire stations, and post offices.
- **Village** – includes villages that may contain a mixture of different land uses. This category may include residential, commercial, institutional, recreational, governmental, industrial and other development uses normally found within developed areas.
- **Nursery** – includes areas used for growing a variety of plants or trees under intensive management for use in another location.
- **Quarry** – an area used for the mining and extraction of mineral resources.
- **Industrial** – includes light manufacturing operations such as machine shops, heavy operations such as steel mills and power plants, warehouse facilities, and all related production facilities and offices.
- **State Game Lands** – includes lands managed by the Pennsylvania Game Commission for hunting, trapping, and fishing.

EXISTING LAND USE

The Richfield-Dalmatia Study Area exhibits diverse land use patterns, from significant farmland and woodland acreage to small villages, hamlets, and residential housing scattered throughout the area. Existing land use is described below, itemized by land use category.

Agricultural Land: Agriculture is the largest land use classification within the Study Area. This category includes lands presently or recently used for various farming activities, such as cropland, pasture, and confined feeding. As shown on the Existing Land Use map, agricultural areas are located throughout the limestone-based valleys. Many of the Study Area's active agricultural communities are inhabited by the Plain Sect population making this area unique in both cultural and architectural settings.

Residential Land: The Study Area is rural in nature so most residential dwellings are found along roads within the area or nestled in small woodlots. A large percentage of the housing stock in the area was constructed prior to 1940. But an equally large number of houses have been constructed since 1950.

Commercial: Small commercial land uses occur primarily along US Route 11/15, PA Route 104, PA Route 147, and at scattered locations throughout the Study Area.

Nurseries: Several tree nurseries are located within the study area. These nurseries include areas where Christmas trees and other ornamental trees are grown.

Public and Semi-Public Land: Public and semi-public land uses inventoried in the Study Area include schools, churches, post offices, emergency services, cemeteries, and other public uses.

Public schools in the Study Area include: Perry West Elementary School located southwest of Mount Pleasant Mills in Perry Township; and Dalmatia Elementary School in Dalmatia, Lower Mahanoy Township. In addition to public schools there are several Amish schools located within the Study Area.

Other, smaller public or institutional uses include the area's municipal buildings, churches, cemeteries, and recreation areas.

Villages and Hamlets: The Village of Dalmatia is the largest village located in the eastern section of the Study Area. Dalmatia is situated on the east shore of the Susquehanna River in Lower Mahanoy Township. To the east of Dalmatia is the crossroad hamlet of Hickory Corners.

On the western side of the Susquehanna River in Chapman Township are the hamlets of: Meiserville at the intersection of PA Route 104 and Meiserville Road; Locust Grove; and Independence, located along the west shore of the Susquehanna River. In Perry Township are located: the village of Mount Pleasant Mills; and the hamlets of Shadle and Aline.

Quarry Land: an open pit quarry operation is located along Toad Valley Road to the east of the Sunbury-Dauphin 69 kV line at the extreme eastern edge of the Study Area.

Industrial Land: The Study Area contains few areas devoted to industrial use. Two major industrial uses in the vicinity of US Route 11/15 and PA Route 104 include Excel Modular Homes, a modular home manufacturing facility, and Mahantango Enterprises, Inc. a tire recycler.

State Game Lands: The Pennsylvania Game Commission maintains two State Game Lands within the Study Area. State Game Lands # 194 is located in Perry Township, Snyder County and is comprised of 721 acres of land. A very small portion of State Game Lands #258 is located on Browns Island in the Susquehanna River across from Dalmatia.

C. MUNICIPAL ZONING AND SUBDIVISION AND LAND DEVELOPMENT ORDINANCES

The Pennsylvania Municipalities Planning Code (MPC) provides the legal framework for local governments to enact, administer and enforce zoning, and subdivision and land development regulations. Zoning is a method a community may use to regulate the use of land and buildings and is designed to protect public health, safety, and welfare, and to guide growth. In contrast, subdivision and land development regulations do not control which uses are established within the municipality nor where a use or activity can or cannot locate; rather, it controls how a use or activity relates to the land upon which it is located.

As shown in the following table, none of the six townships within the study area have enacted a zoning ordinance. Four townships have adopted a subdivision and land development ordinance. In addition, none of the six municipalities have adopted a comprehensive plan and only one has an active planning commission board.

Status of Land Use Regulations by County and Township

| Municipality | Comprehensive Plan | Zoning Ordinance | Subdivision & Land Development Ordinance | Planning Commission |
|--|--------------------|------------------|--|---------------------|
| Monroe Township (Juniata County) | No | No | No | No |
| Susquehanna Township (Juniata County) | No | No | Yes | No |
| Lower Mahanoy Township (Northumberland County) | No | No | No | Yes |
| Chapman Township (Snyder County) | No | No | Yes* | No |
| Perry Township (Snyder County) | No | No | Yes* | No |
| West Perry Township (Snyder County) | No | No | Yes* | No |

* Regulated by the Snyder County Subdivision and Land Development Ordinance.

D. AGRICULTURAL PRESERVATION – MAP 3

As recognized by the American Farmland Trust, Pennsylvania leads the nation in the number of farms and acres of farmland protected. Juniata, Northumberland, and Snyder Counties maintain Agricultural Land Preservation Boards which administer the establishment of Agricultural Security Areas (“ASAs”) and the purchase of Agricultural Easements. An ASA is an area of 500 or more semi-contiguous acres (250 acres in Juniata County) that is used for agricultural production. Farmers voluntarily form and/or join ASAs as a way of receiving special consideration with regard to regulations, nuisance complaints and conflicting land uses. The Agricultural Easement purchase program allows counties to tap the Pennsylvania farmland preservation fund through the purchase of development rights. Qualifying farms must be part of an existing ASA, and are rated based on soil quality, proximity to other farmland, and other criteria. Once a

farm is in easement, agricultural production must continue every year thereafter, with no new structures except farm accessory buildings.

Map 3 shows ASAs. Currently no farms listed are in the Agricultural Easement program within the Study Area. Protocol when planning transmission line routes is to avoid crossing preserved farmland and ASAs when it makes sense to do so. It must be noted, however, that transmission line construction across these areas is expressly permitted by the statutes authorizing agricultural security easements and, thus, is not inconsistent with this land use classification.

E. SOIL CHARACTERISTICS – MAP 4

The characteristics of soils are important factors in transmission line siting. Some soil or rock conditions can pose problems in engineering and construction of foundations. Environmental impacts can also occur with erosive soils and with re-vegetation of the right-of-way if droughty soils are found, especially on steeper slopes.

Using U.S.D.A. Natural Resources Conservation Service (“NRCS”) soil surveys for Juniata, Northumberland, and Snyder Counties, the Study Area was analyzed and mapped to identify the most significant soil characteristics and problem areas.

Three soil characteristics were identified in the Study Area as significant to transmission line siting, including construction, operation and maintenance, which are as follows:

- Hydric Soils (*High / Seasonally High Water Table soils*)
- Soils with Hydric Components
- Shallow Depth to Bedrock Soils

Hydric soils (*High / Seasonally High Water Table soils*) are soils with a water table at a depth of 36 inches or less. Soils of this type are a good indicator of wetland areas. Hydric soils within the Study Area are largely confined to stream valleys and areas with poor drainage. Soils with hydric components are either found in conjunction with hydric soils, along shallow drainage ways or in low lying areas. Wet soils can create access issues during construction and maintenance due to the unstable ground. In addition, these soils create problems for foundation installation which can increase costs.

Shallow Depth to Bedrock soils, with bedrock found at a depth of 36 inches or less, are found in both upland and lowland areas of the Study Area. Shallow depth to bedrock soils are the most prevalent soil type found in both Northumberland and Snyder Counties. There are minimal areas of shallow depth to bedrock soils within the Juniata County portion of the Study Area. Such areas pose problems for installing foundations and can create increased costs.

Other soils that were identified and mapped within the Study Area include Class I and Class II prime agricultural soils. The United States Department of Agriculture (“USDA”) defines prime farmland soils as the land best suited to food, feed, forage, fiber, and oilseed crops. Prime farmland produces the highest yields with minimal inputs of energy and economic resources, and farming these soils results in the least damage to the environment. Counties also use prime agricultural soils as a determining factor in purchasing agricultural easements (described further under *Map 3*). Although these soils exhibit few constraints for the construction of transmission lines, it is prudent to avoid excessive structure footprints over these highly farmable areas whenever practical.

F. STEEP SLOPES – MAP 5

Identification of steep slopes is very important to transmission line siting. The steeper the slope, the more difficult and costly it is to clear vegetation, maneuver

construction and maintenance equipment, handle, haul and erect transmission structures and grade access roads and structure sites. Drainage, erosion control and vegetation management problems generally increase with more severe slopes, especially when a line crosses perpendicular to the slope. Also, steep slopes by nature of geometry are more visually sensitive.

Steep slopes were classified based on commonly-accepted land use planning methods, which are as follows:

- 8-15 percent slopes, where development density restrictions are often recommended.
- 15 percent and greater slopes, where development is often severely restricted or prohibited.

Generally, steep slopes in the Study Area are located on the faces of the northeast-southwest trending ridges. Prominent ridges and their associated steep slopes include:

- Lime Ridge (*Snyder County*)
- Forrey Ridge (*Snyder County*)
- The Long Woods (*Snyder County*)
- Graders Ridge (*Juniata County*)
- Turkey Ridge (*Juniata County*)
- Dresslers Ridge (*Juniata County*)
- Fisher Ridge (*Northumberland County*)
- Hooflander Mountain (*Northumberland County*)

Throughout the remainder of the Study Area, lesser areas of steep slopes are scattered on hillsides, along stream valleys, and the sides of ravines.

G. NATURAL FEATURES – MAP 6

The natural features inventory and map represent a compilation of those natural elements in the environment that are considered to be significant to transmission line siting and construction. Map 6 shows major natural features in the Study Area, including natural vegetation, surface waters, floodplains, wetlands, and unique natural areas. Wildlife habitat, both terrestrial and aquatic, is confined largely to these resources.

WOODLANDS AND NATURAL VEGETATION

The Study Area contains a variety of vegetation, ranging from cropland, grass and scrublands to naturally-occurring floodplain forests and upland forests. Major woodlands within the Study Area are depicted on Map 6.

Forest land is valued for many reasons. It provides recreational opportunities for nature study, hunting, hiking, horseback riding and scenic views. In addition to recreational activities, the county's forests are used for firewood harvesting, commercial timbering, and as land use buffers and boundaries. Many plant and animal species depend on large, unbroken wooded tracts for survival. The forests also mitigate environmental stress by reducing stormwater runoff, increasing groundwater recharge filtration, improving erosion and sedimentation control, regulating local climates, and purifying air.

According to the USDA Forest Service, hardwoods by volume are the most prevalent species group in the Study Area. Stands of second- and third-growth trees make up the woodland. The most common hardwood species are white oak, red oak, ashes, hickory, maple, black walnut, aspen, birch, and basswood. Softwood species, particularly pine and hemlock, also exist in the Study Area.

Woodlands provide many important uses, one of which is in providing erosion control, especially on steep slopes, and protecting watersheds. The control of erosion on steep slopes is achieved through the root's ability to hold soil and rock

in place. This allows the forests surrounding watersheds to keep runoff low in suspended solids, such as soil particles, which helps to keep lakes and streams free from sediment. Forests control erosion in another important method. Tree cover reduces the impact of falling water droplets on the surrounding soil by intercepting them in the tree crown. The water then either falls from the leaves with a much reduced velocity, or is transmitted to the tree's branches and trunk where it reaches the soil as stem flow. This reduction of the rainwater's impact on the soil prevents particles from being dislodged and becoming water carried sediment.

Woodlands are also important areas of animal habitat. Many larger species such as deer and bear depend on the cover of the forest for their protection and ultimate survival.

Vegetation in non-woodland areas is almost always the result of human activity. This includes crops such as corn and soybean, common grasses in lawns, parks, pastures and roadsides, and taller grasses and shrubs in unmowed vacant areas.

SURFACE WATERS

The Study Area is located in the Lower Central Susquehanna Watershed (Subbasin 6). Surface waters include rivers, streams and ponds which provide aquatic habitat, carry or hold runoff from storms, and provide recreation and scenic opportunities.

The following major water resources are found within the Study Area:

- Susquehanna River
- North Branch Mahantango Creek (*Snyder County*)
- West Branch Mahantango Creek (*Snyder & Juniata Counties*)
- Aline Creek (*Snyder County*)
- Hoffer Creek (*Snyder County*)

- Boyers Run (*Juniata County*)
- Quaker Run (*Juniata County*)
- Leininger Run (*Juniata County*)
- Mahantango Creek (*Northumberland County*)
- Dalmatia Creek (*Northumberland County*)

Pennsylvania's Water Quality Standards designate protection categories for streams, which are the basis of water quality criteria. These classifications are important in regulating the discharge of wastewater and stormwater into streams. Cold Water Fisheries ("CWF") are streams that should be protected as habitat for cold water fish and other fauna and flora indigenous to cold water. Trout Stock Fisheries ("TSF") are streams that qualify for trout stocking by the Pennsylvania Fish and Boat Commission. Trout-stocking streams with excellent water quality are dubbed as High Quality Trout Stock Fisheries ("HQ-TSF").

Exceptional Value ("EV") streams have excellent water quality, are important local or regional resources, and commonly flow through a state or national recreation area. Migratory Fishes ("MF") are rivers and streams that provide for passage, maintenance and propagation of anadromous and catadromous fishes and other fishes which move to or from flowing waters to complete their life cycle in other waters.

The following table shows State designations for streams within the Study Area:

State Protection Designations for Streams

| STREAM | STREAM SEGMENT / AREA | DESIGNATION |
|--|---|--------------------|
| Aline Creek | Basin | CWF, MF |
| Boyers Run | Basin | Unclassified |
| Dalmatia Creek | Basin | WWF, MF |
| Hoffer Creek | Basin | WWF, MF |
| Leininger Run | Basin | CWF, MF |
| Mahantango Creek | Basin, Pine Creek to Mouth | WWF, MF |
| North Branch Mahantango Creek | Main Stem, Source to Confluence with West Branch | TSF, MF |
| Quaker Run | Basin | CWF, MF |
| Susquehanna River | Main Stem, West Branch Susquehanna River to Juniata River | WWF, MF |
| West Branch Mahantango Creek | Main Stem, Source to Confluence with North Branch | TSF, MF |
| Unnamed Tributaries to North Branch Mahantango Creek | Basins, Source to Confluence with West Branch | CWF, MF |
| Unnamed Tributaries to West Branch Mahantango Creek | Basins, Source to Confluence with North Branch | CWF, MF |

In addition to streams, the Study Area also contains numerous small ponds. Most of these ponds are man-made and are located on private property.

100-YEAR FLOODPLAINS

100-year floodplains are areas that would be inundated in a storm severe enough to occur only once in 100 years, according to the Federal Emergency Management Agency (“FEMA”). The 100-year floodplain boundaries shown on Map 6 were acquired digitally from Penn State University and were originally derived from Flood Insurance Rate Maps (“FIRM”) and SCS County Soil Surveys. Development in 100-year floodplains is usually restricted or prohibited. The risks to human life, property, and water quality during flood events are the rationale for imposing these restrictions. Utilities are one of the few allowed uses within floodplains. Transmission lines are commonly allowed in floodplains, as long as they are designed, located and constructed to minimize flood damage.

In the Study Area, 100-year floodplains are located along the entire length of the Susquehanna River. Floodplains surround the North Branch of the Mahantango Creek, and the West Branch of the Mahantango Creek and their tributaries in the western section of the Study Area. In the eastern section of the Study Area, floodplains can be found along Dalmatia Creek and Mahantango Creek.

WETLANDS

In addition to surface streams, groundwater resources, and floodplains, another important component in the Study Area hydrology is wetlands.

Wetlands are classified as two types: tidal (coastal wetlands) and nontidal (inland / palustrine). The wetlands found in the Study Area are nontidal, and may include freshwater marshes and ponds, shrub swamps, wooded swamps, and areas along the creeks and streams. The three common kinds of nontidal wetlands are: (1) emergent, (2) scrub-shrub, and (3) forested. Emergent wetlands are characterized by non-woody vegetation less than 20 feet tall.

Scrub-shrub contains smaller ground plants, while forested wetlands are those dominated by trees (20 feet or higher). These various classifications and characteristics are outlined and identified on the National Wetland Inventory mapping prepared by the U.S. Fish and Wildlife Service.

Wetlands in the state are important for four principal reasons. They provide habitats for most threatened and endangered species. Wetlands provide food for game fish and other animals, as well as nesting birds. They function to reduce flooding by absorbing additional water and slowing the pace of water to neighboring creeks and streams. Wetlands also act to buffer creeks and streams from excessive erosion and sedimentation.

NATURAL HERITAGE SITES

County Natural Heritage Inventories showcase the Western Pennsylvania Conservancy's science efforts by combining and presenting information on unique plants, animals, natural ecological communities, and other important natural resource in Pennsylvania. These projects identify, map and discuss important places within a county, prioritize them based upon their attributes, and provide recommendations regarding their management and protection.

The following sources were used to determine the location, and type of significant features of those heritage areas found within the Richfield-Dalmatia Study area:

- Juniata County Natural Heritage Inventory – 2007
- Northumberland County Natural Areas Inventory – 2008
- Snyder County Natural Heritage Inventory - 2007

Natural Heritage Sites

| NATURAL AREA | MUNICIPALITY | SIGNIFICANT FEATURE |
|--|---|---|
| Malta Cliffs | Lower Mahanoy Township Northumberland County | Jeweled shooting star (<i>Dodecatheon radicum</i>) |
| Mahantango Creek Outcrops | Lower Mahanoy Township Northumberland County | Elktoe (<i>Alasmidonta marginata</i>), a mussel Yellow lampmussel (<i>Lampsilis cariosa</i>) Jeweled shooting star (<i>Dodecatheon radicum</i>) |
| Susquehanna River at McKees Half Falls | Northumberland County | Elktoe (<i>Alasmidonta marginata</i>), a mussel Yellow lampmussel (<i>Lampsilis cariosa</i>) Triangle Floater (<i>Alasmidonta undulata</i>) |
| Susquehanna River At SGL #233 South | Northumberland County | Yellow lampmussel (<i>Lampsilis cariosa</i>) |
| Susquehanna River at SGL #258 | Northumberland County Juniata County | Elktoe (<i>Alasmidonta marginata</i>), a mussel Yellow lampmussel (<i>Lampsilis cariosa</i>) Triangle Floater (<i>Alasmidonta undulata</i>) Species of Concern* Species of Concern* |
| Mahantango Creek Confluence Pools | Susquehanna Township Juniata County | Isolated collection of an ephemeral/fluctuating natural pools community. |

*This species is not named at the request of the agency overseeing its protection

THE SUSQUEHANNA RIVER

The Susquehanna River within the Richfield-Dalmatia Study Area provides habitat for a diverse community of freshwater mussels, a group of animals considered the most imperiled in North America.

Conservation and recovery of freshwater mussels in the Susquehanna River is not only dependent on maintenance of water quality and flows in the river, but also on conservation practices in terrestrial habitats.

Freshwater areas are indirectly affected by erosion and chemical runoff in the surrounding uplands of the watershed. Siltation and removal of riparian vegetation can destabilize the river substrates and eliminate habitat for bottom-dwelling organisms such as mussels. Populations of rare mussels are generally dependent on conservation practices that will improve and maintain water quality and restore natural flows in the river. Reduction of erosion and chemical runoff, restoration and maintenance of riparian forested buffers and restoration of natural flows will all improve habitat for freshwater mussels and associated aquatic organisms.

G. GEOLOGY – MAP 7

The entire Study Area falls within the Susquehanna Lowland Section of the Ridge and Valley Physiographic Province. The Susquehanna Lowland Section's dominant topographic features include low to moderately high relief; linear ridges; linear valleys; and the Susquehanna River Valley.

The Study Area's underlying geologic formations shape the topography of the landscape and determine the water-bearing characteristics of aquifers. Geologic formations can also restrict the nature and extent of surface development. In addition, the underlying rock is subject to forces that erode its original shape and form soils. These soils possess distinct characteristics that often impact land use decisions.

Geology is also a primary determinant of groundwater quality and quantity. Certain rock types and structures convey water better and serve as more abundant well sources. Rock type and structure can affect the degree of groundwater filtration that takes place. Chemical composition of the rock can also contribute to the chemical properties of its groundwater. The Richfield-Dalmatia Study Area geology consists primarily of sedimentary rock layers, which cross the area in an east to west fashion.

Portions of the Study Area's landscape are underlain by limestone based geologic formations (Geology Map). Limestone, which is a carbonate rich material, is highly soluble and susceptible to the formation of solution caverns and sinkholes (i.e., karst topography). Karst refers to any terrain where the topography has been formed chiefly by the dissolving of rock. Landforms associated with karst include sinkholes, caves, sinking streams, springs, and solution valleys.

Underlying Bedrock Formations

| Name | Geologic Period | Description |
|--|----------------------------|--|
| Bloomsburg & Mifflintown Formations, undivided | Silurian | Red shale and siltstone with local units of sandstone, thin impure limestone, some green shale |
| Clinton Group | Silurian | Fossiliferous shale with intertonguing "iron sandstones" and local gray fossiliferous limestones; quartzitic sandstone |
| Duncannon Member of Catskill Formation | Devonian | Grayish-red sandstone, siltstone, and mudstone in fining-upward cycles; conglomerate occurs at base of some cycles |
| Hamilton Group | Devonian | Dark gray, laminated shale, siltstone, and very fine-grained sandstone |
| Irish Valley Member of Catskill Formation | Devonian | Made up of mostly siltstone, with mudstone and sandstone |
| Keyser and Tonoloway Formations, undivided | Devonian and Silurian | Primarily limestone with some shale |
| Mauch Chunk Formation | Mississippian | Grayish-red shale, siltstone, sandstone, and some conglomerate; some local nonred zones. Includes Loyalhanna Member (crossbedded, sandy limestone) at base in south-central and southwestern Pennsylvania |
| Onondaga and Old Port Formations, undivided | Devonian | Calcareous shale is predominant; sandstone; limestone; argillaceous limestone; chert; shale; siliceous siltstone; bentonite |
| Pocono Formation | Mississippian | Sandstone, conglomeratic sandstone, and shale with carbonaceous partings and impure coal beds |
| Sherman Creek Member of Catskill Formation | Devonian | Alternating grayish-red mudstone and siltstone in poorly defined fining-upward cycles, and minor intervals of gray sandstone |
| Spechty Kopf Formation | Mississippian and Devonian | Light- to olive-gray, fine- to medium-grained, cross-bedded sandstone, siltstone, and local polymictic diamictite, pebbly mudstone, and laminite; arranged in crude fining-upward cycles in some places; locally has grayish-red shale near top and conglomerate at base and in middle |
| Trimmers Rock Formation | Devonian | Predominantly siltstone, also included are shale, sandstone, and black shale |
| Tuscarora Formation | Silurian | Sandstone and quartzite; fine to coarse grained; conglomeratic in part; conglomerate may be loosely cemented |
| Wills Creek Formation | Silurian | Greenish-gray shale with local limestone and sandstone zones; contains red shale and siltstone in the lower part of the Formation |

I. CULTURAL AND HISTORIC FEATURES – MAP 8

Map 8 depicts the location of significant cultural/historic features within two miles of the preferred transmission line route. The features identified within the Study Area are limited to historic sites.

HISTORIC SITES

The Bureau for Historic Preservation administers the National Register of Historic Places for Pennsylvania. The program was established by the National Historic Preservation Act of 1966 and the Pennsylvania History Code. Properties listed on the Register include districts, sites, buildings, structures, and objects that are significant in American history, architecture, archeology, engineering, and culture. National Register properties are distinguished by having been documented and evaluated according to uniform standards. Listing on the National Register does not interfere with a private property owner's right to alter, manage, or dispose of property.

The following tables list buildings/structures found in the Study Area that are listed on the National Register of Historic Places. These include buildings/structures officially *listed* and *eligible* to be listed. Site location, municipality and listed/eligible status are shown in the tables below. Location descriptions are quoted directly from the Pennsylvania Historic and Museum Commission. Numbers in the far-left column correspond with number labels on Map 8.

Listed National Register Historic Sites

| # | SITE NAME | LOCATION | MUNICIPALITY | STATUS |
|---|---|-----------------------|--|--------|
| 1 | Aline Covered Bridge - Structure | 40°40'35"N 76°58'46"W | Perry Township, Snyder County | Listed |
| 2 | East Oriental Covered Bridge - Structure | 40°38'20"N 77°00'05"W | Perry Township, Snyder County and Susquehanna Township, Juniata County | Listed |
| 3 | North Oriental Covered Bridge - Structure | 40°39'42"N 77°00'41"W | Perry Township, Snyder County and Susquehanna Township, Juniata County | Listed |

Eligible to be Listed National Register Historic Sites

| # | SITE NAME | LOCATION | MUNICIPALITY | STATUS |
|----|---|---|--|----------|
| 4 | Dauphin County Bridge No. 27 Bridge - Structure | Deibler's Dam Rd, | Lower Mahanoy Township, Northumberland County and Mifflin Township, Dauphin County | Eligible |
| 5 | Backus-Leight Dwelling | | Perry Township, Snyder County | Eligible |
| 6 | Herrold, Frederick, House | Tax Parcel 5-02-050 | Chapman Township, Snyder County | Eligible |
| 7 | Herrold, Family Structure No. 3 | Tax Parcel 5-02-050 | Chapman Township, Snyder County | Eligible |
| 8 | Herrold-Reichenbach House & Store | Tax Parcel 18-01-130A | Chapman Township, Snyder County | Eligible |
| 9 | Independence School | Tax Parcel 0-05-009 | Chapman Township, Snyder County | Eligible |
| 10 | McKees Half Falls Historic District | | Chapman Township, Snyder County | Eligible |
| 11 | Meiser, Frederick, Grist Mill | | Perry Township, Snyder County | Eligible |
| 12 | Pennsylvania Canal, Susquehanna Division | | Chapman Township, Snyder County | Eligible |
| 13 | Rine, J.S., House | | Chapman Township, Snyder County | Eligible |
| 14 | Saint Johns Church & Cemetery | Tax Parcel 05-02-34; Tax Parcel 05-02-27 | Chapman Township, Snyder County | Eligible |

The Ressler Frame House property located in Lower Mahanoy Township, Northumberland County is listed as eligible for inclusion on the National Register of Historic Places. However, the location of this site could not be determined.

The Pennsylvania Canal, Susquehanna Division, closely paralleled present day US Route 11/15 through the Study Area. The canal closed in 1901, although some local sections operated until the commencement of construction of US Route 11/15 in 1949. Vestiges of components related to the operation of the canal of the canal still exist today. PPL Electric will determine if the proposed route of the Richfield-Dalmatia 69 kV Tie Line will impact any of these canal components and take necessary steps to mitigate any impacts to these relics.

ARCHAEOLOGICAL SITES

Improvements to US Route 11/15 were sponsored by the Pennsylvania Department of Transportation (“PennDOT”) and the Federal Highway Administration (“FHWA”). As part of the cultural resource studies that were mandated by PennDOT and the FHWA, archaeological investigations were conducted prior to construction activity along the highway corridor. The entire US Route 11/15 highway corridor within the Study Area is identified as a prehistoric/historic archaeological site which has been investigated. Due to the fact that all three alternatives cross US Route 11/15 this site is not mapped.

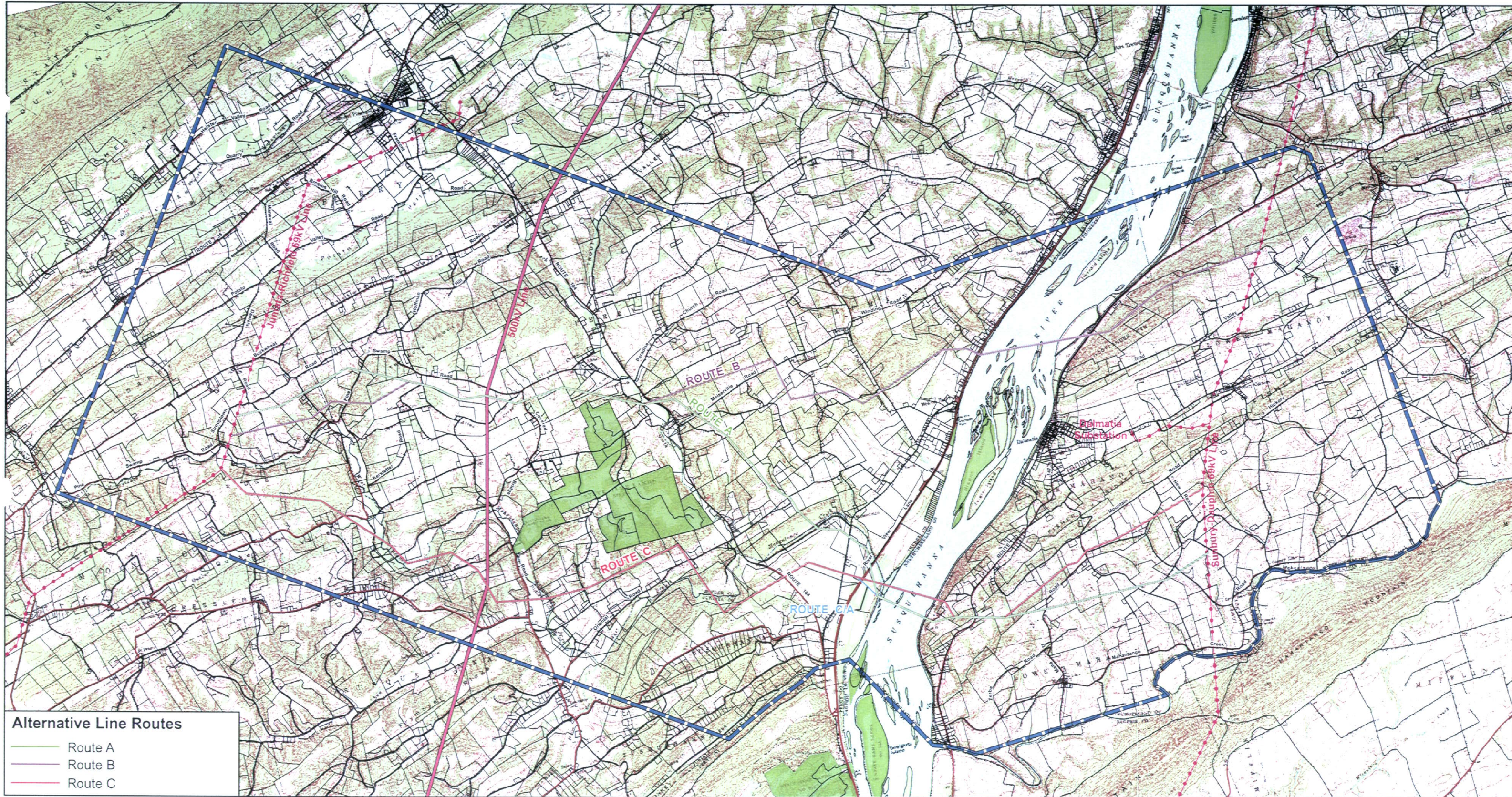

PPL Electric has coordinated with the Pennsylvania Historical & Museum Commission and will take all reasonable steps to minimize the impact on archaeological sites and other resources that may be affected by this project.



Alternative Line Routes

- Route A
- Route B
- Route C

Sources:
 PASDA, Snyder County GIS,
 Juniata County GIS and Urban
 Research & Development Corporation





Legend

Linear Features

- Roads
- Railroads
- 69kV Transmission Lines
- 500kV Transmission Line
- - - Municipal Boundaries
- - - Study Area Boundary

Prepared By:



Map 1

Linear Features

**Richfield-Dalmatia
69 kV Tie Line**

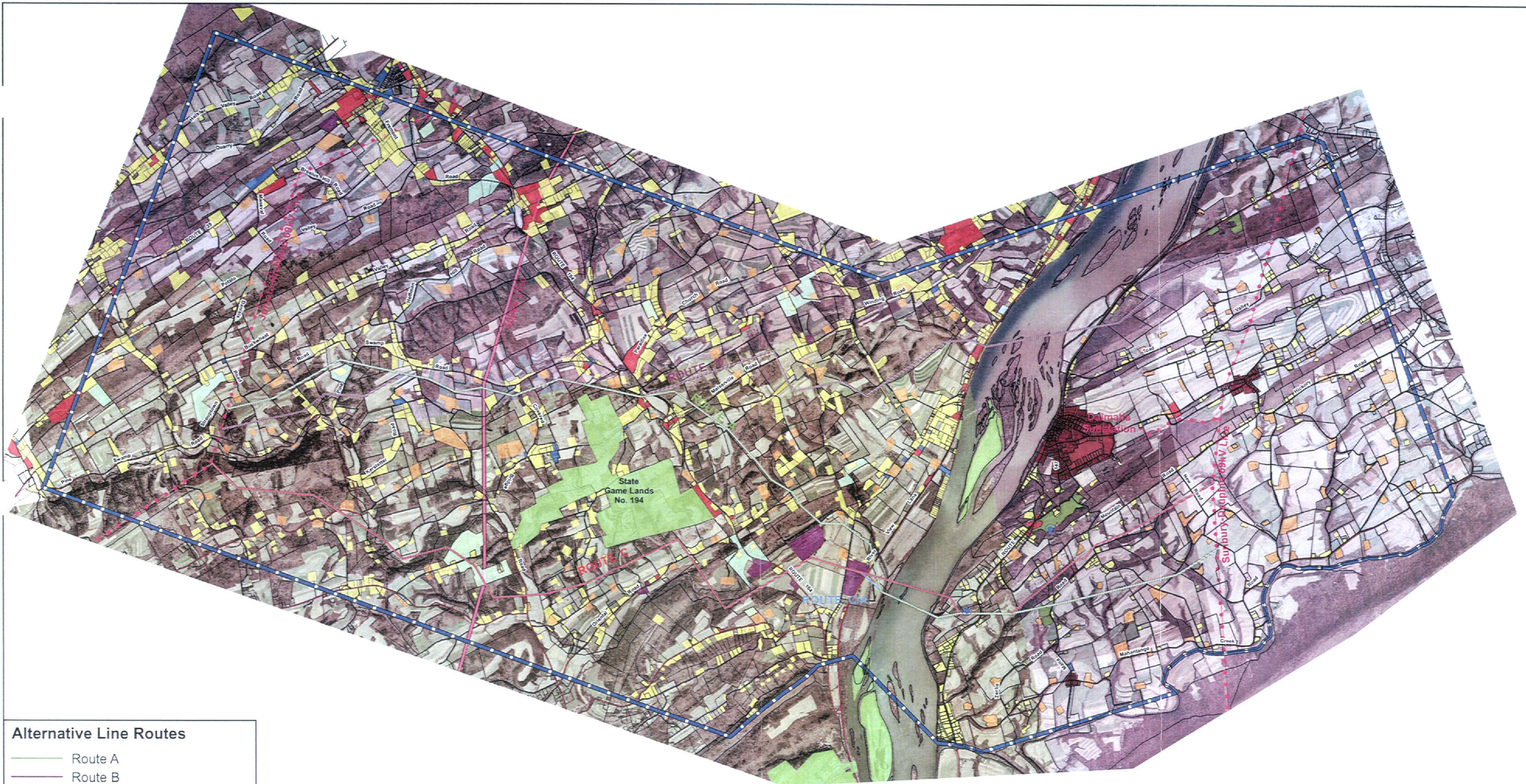

Alternative Line Routes

- Route A
- Route B
- Route C

Source:

PASDA, Snyder County GIS,
Juniata County GIS and Urban
Research & Development Corporation



Legend

- | | |
|---------------------|--------------------|
| Communication Tower | Public/semi-public |
| Farmstead | Village |
| Residential | Quarry |
| Commercial | Industrial |
| Nursery | State Game Lands |

Linear Features

- Roads
- Railroads
- 69kV Transmission Lines
- 500kV Transmission Line
- Municipal Boundaries
- Study Area Boundary

Prepared By:



Map 2
Existing Land Use

Richfield-Dalmatia
69 kV Tie Line

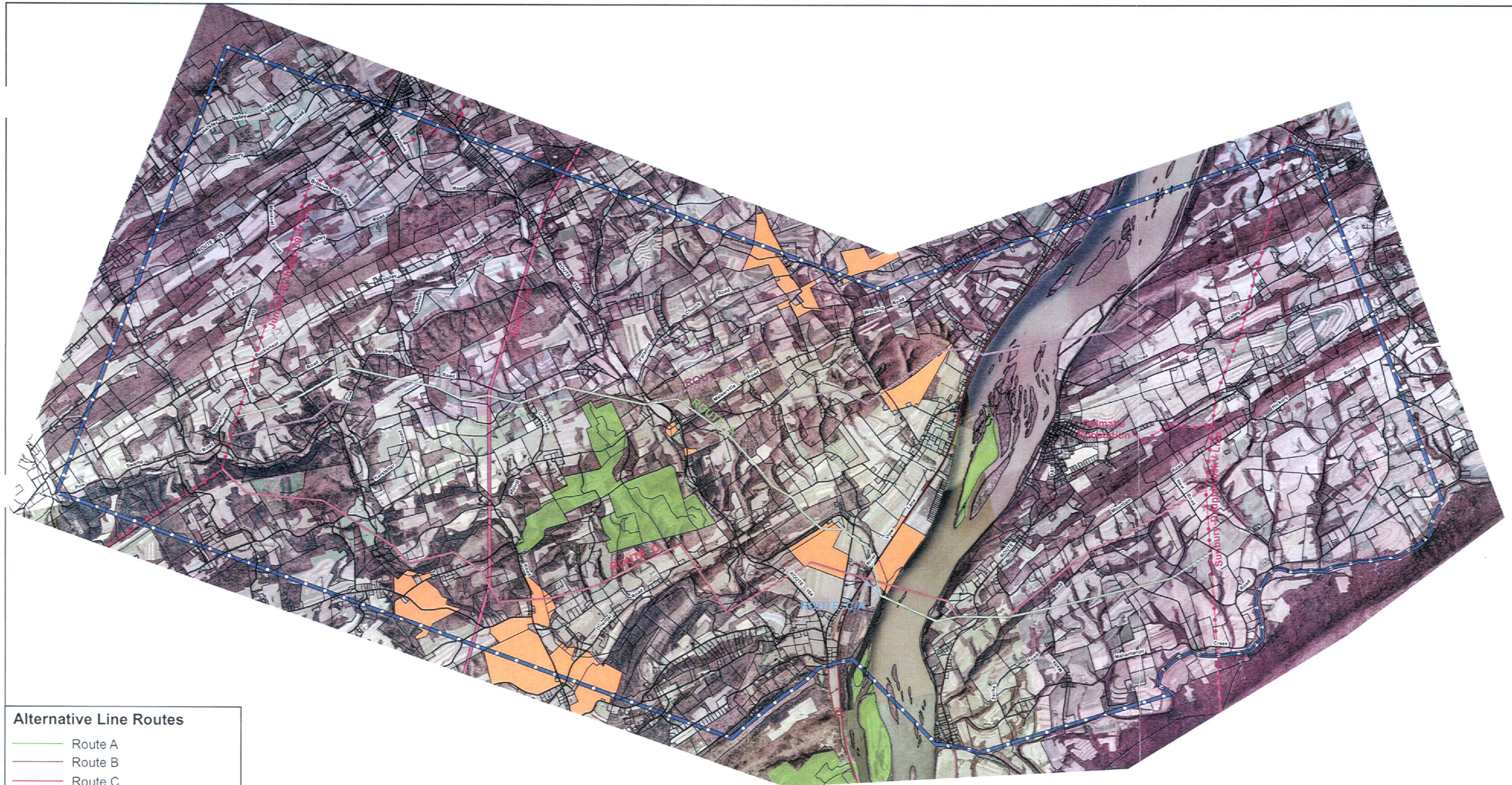

Alternative Line Routes

- Route A
- Route B
- Route C

Source:
PASDA, Snyder County GIS,
Juniata County GIS and Urban
Research & Development Corporation

0 5,000 10,000 Feet

Legend

- Agricultural Security Areas

Linear Features

- Roads
- +— Railroads
- 69kV Transmission Lines
- 500kV Transmission Line
- - - Municipal Boundaries
- |— Study Area Boundary

Prepared By:

Map 3

Agricultural Preservation

**Richfield-Dalmatia
69 kV Tie Line**

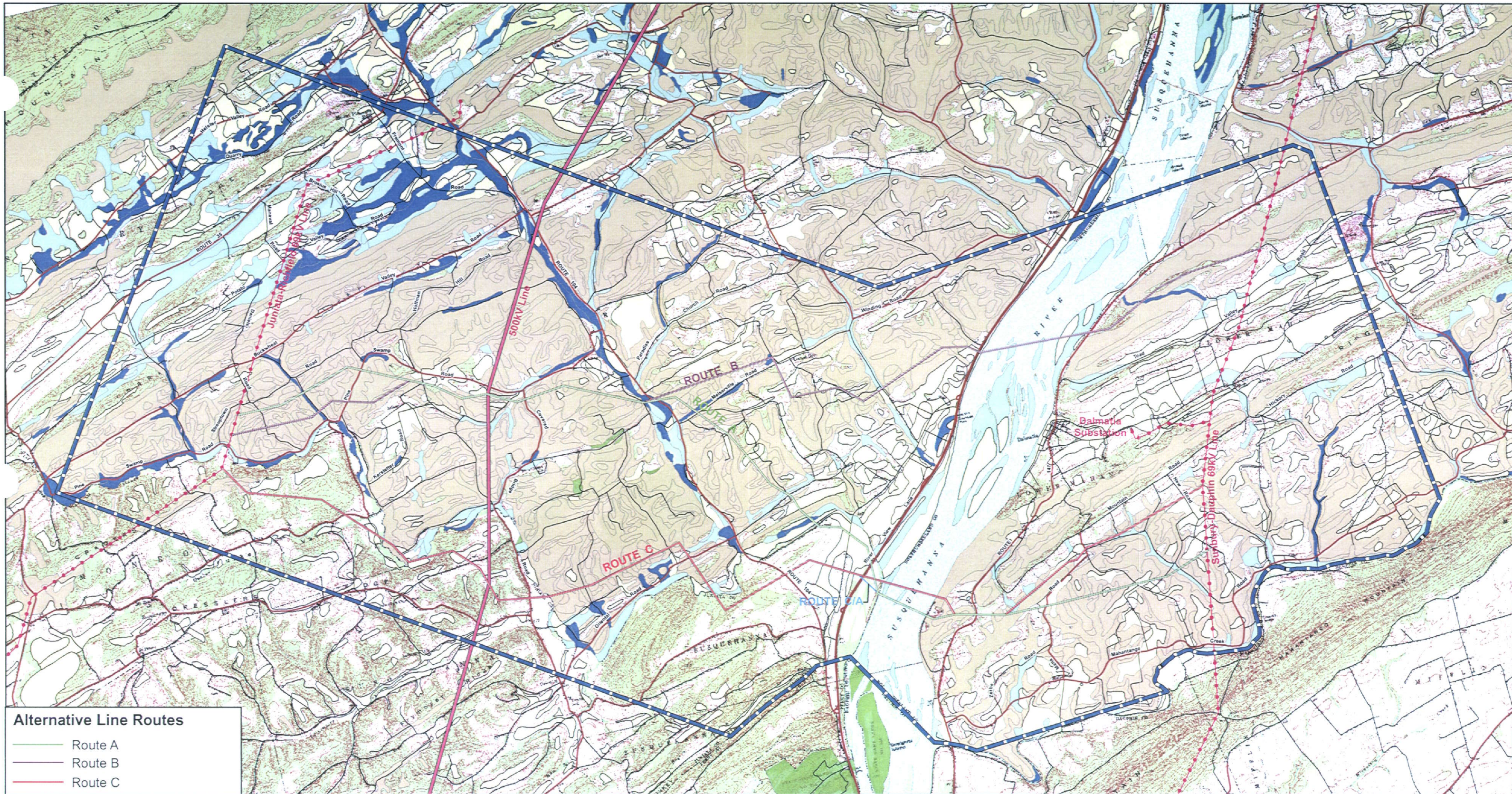

Alternative Line Routes

- Route A
- Route B
- Route C

Source:
 PASDA, Snyder County GIS,
 Juniata County GIS and Urban
 Research & Development Corporation

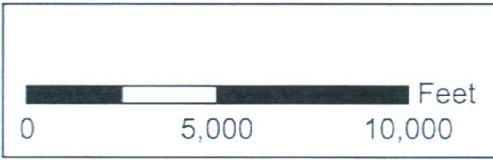

Legend

- Class I & Class II Prime Agricultural Soils *
- Hydric Soils
- Soils with Hydric Components
- Shallow Depth to Bedrock

* May also contain soils with Hydric Components

Linear Features

- Roads
- Railroads
- 69kV Transmission Lines
- 500kV Transmission Line
- - - Municipal Boundaries
- - - Study Area Boundary

Prepared By:

Map 4

Soil Characteristics

**Richfield-Dalmatia
69 kV Tie Line**

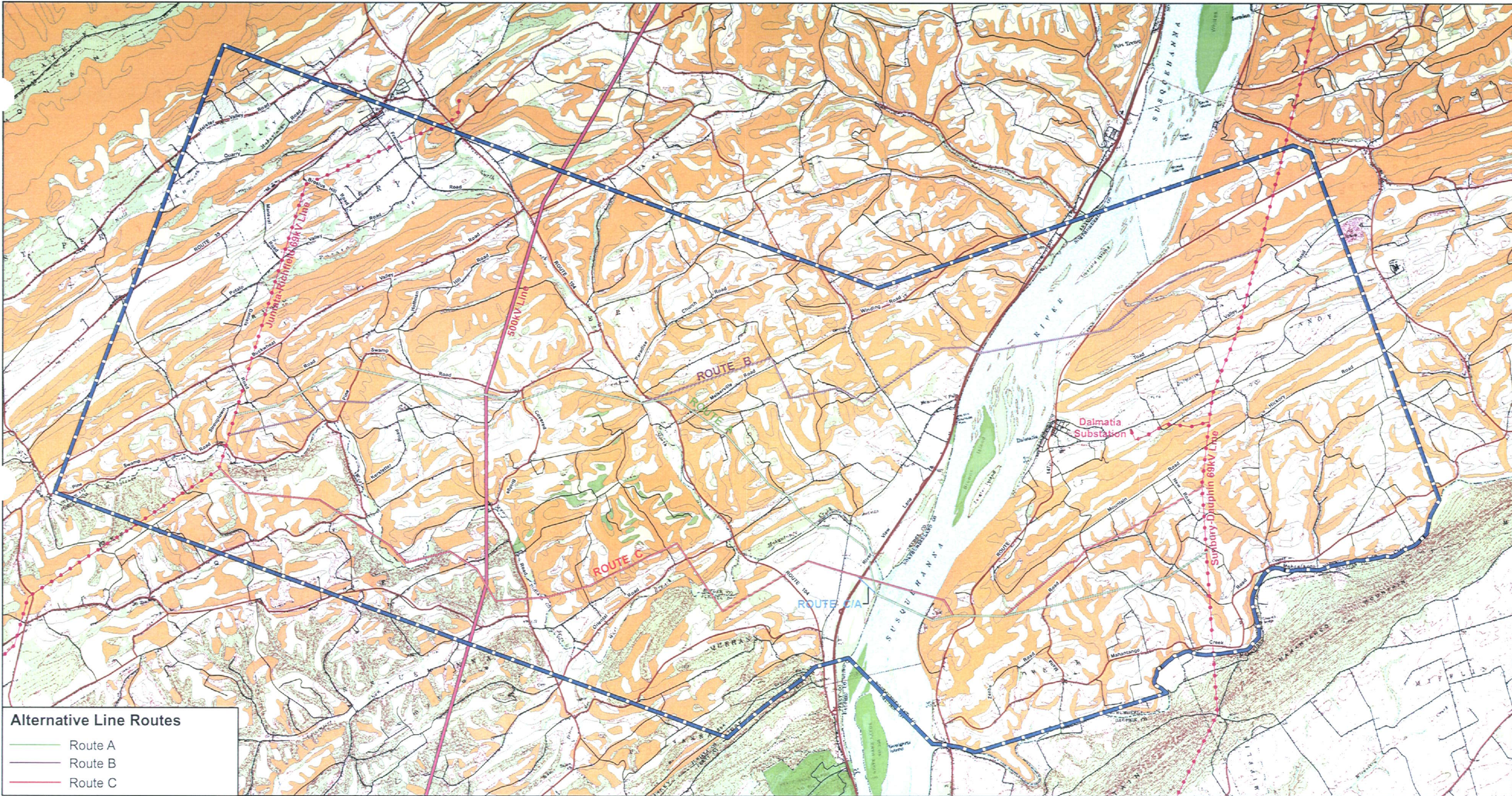

Alternative Line Routes

- Route A
- Route B
- Route C

Source:
 PASDA, Snyder County GIS,
 Juniata County GIS and Urban
 Research & Development Corporation

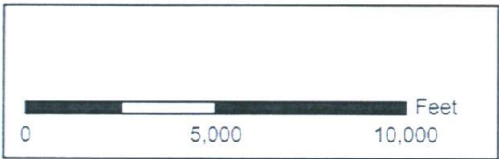

Legend

- Steep Slopes 8-15%
- Steep Slopes 15%+

Linear Features

- Roads
- Railroads
- 69kV Transmission Lines
- 500kV Transmission Line
- - - Municipal Boundaries
- - - Study Area Boundary

Prepared By:

Map 5

Steep Slopes

**Richfield-Dalmatia
69 kV Tie Line**

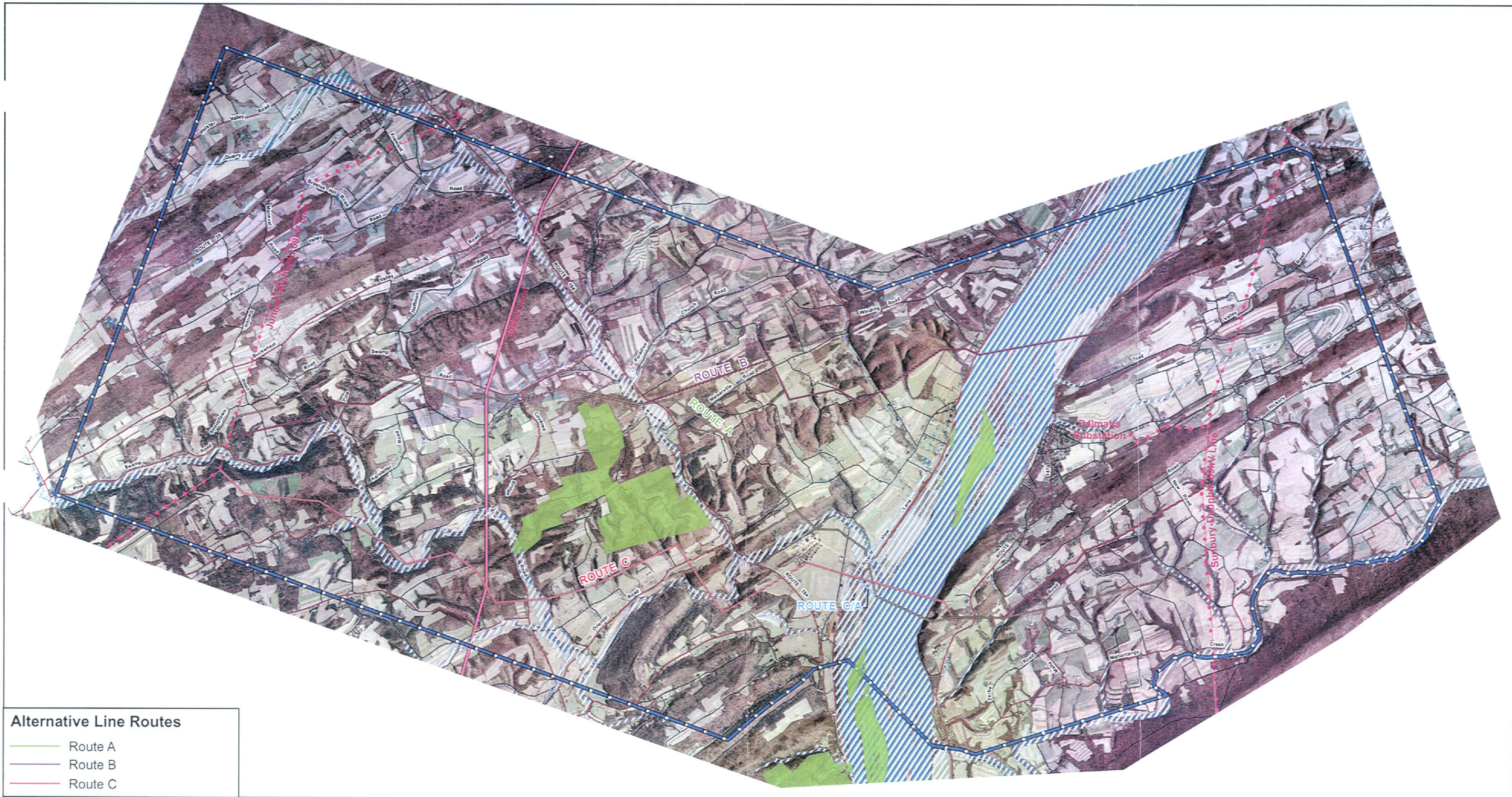

Alternative Line Routes

- Route A
- Route B
- Route C

Source:
 PASDA, Snyder County GIS,
 Juniata County GIS and Urban
 Research & Development Corporation

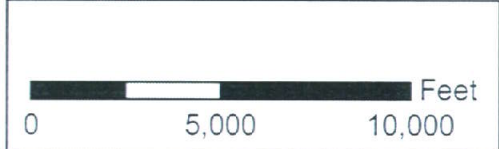

Legend

- - - - Streams
- Wetlands
- 100 Year Floodplains
- Woodlands

Linear Features

- Roads
- Railroads
- 69kV Transmission Lines
- 500kV Transmission Line
- - - - Municipal Boundaries
- - - - Study Area Boundary

Prepared By:

Map 6

Natural Features

Richfield-Dalmatia
69 kV Tie Line

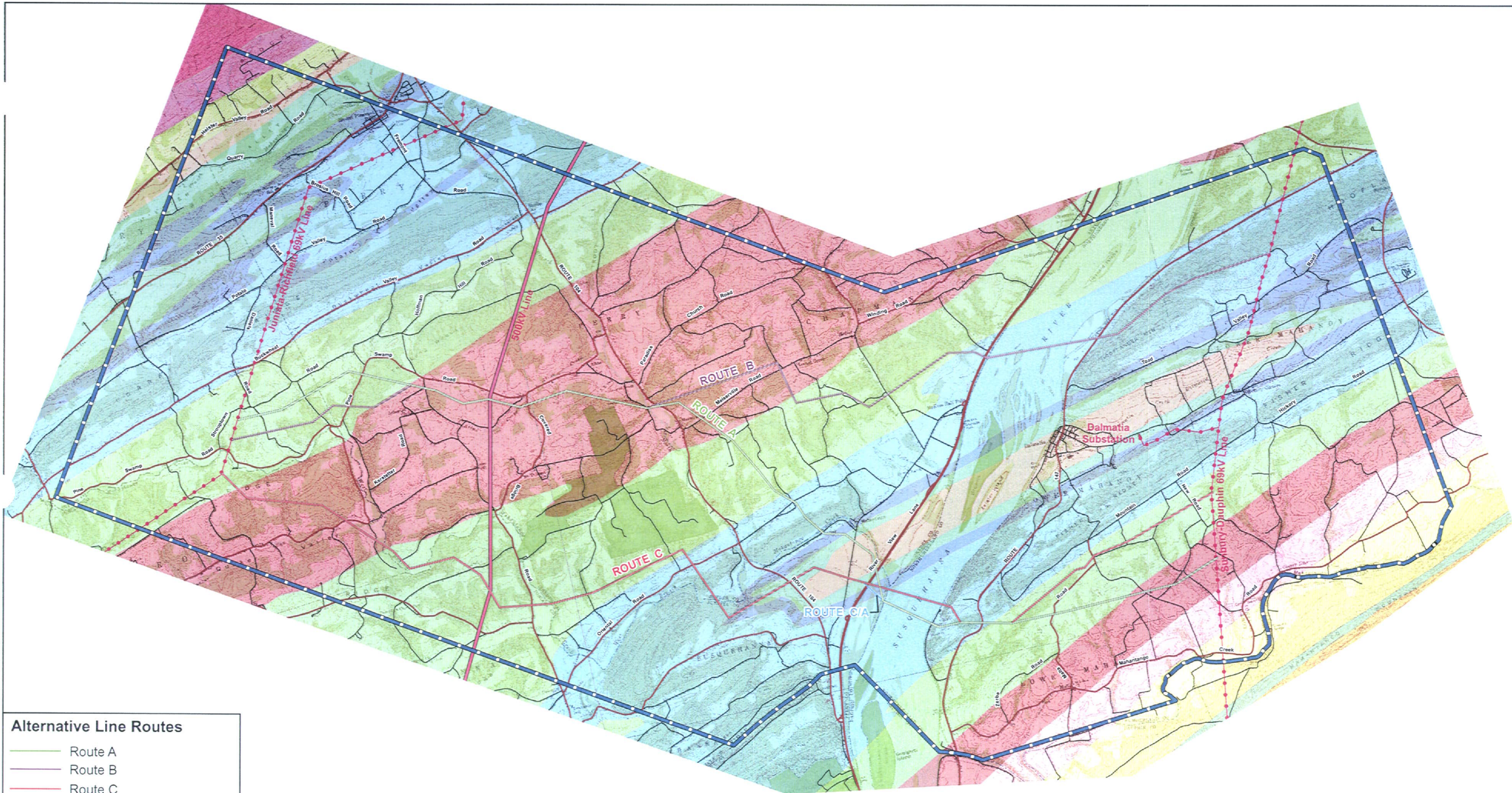

Alternative Line Routes

- Route A
- Route B
- Route C

Source:
 PASDA, Snyder County GIS,
 Juniata County GIS and Urban
 Research & Development Corporation

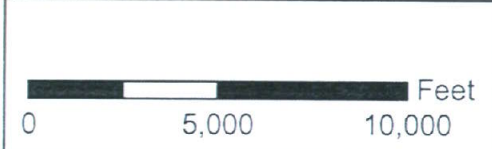

Legend

| | |
|--|---|
| ■ Bloomsburg and Mifflintown Formations, undivided | ■ Onondaga and Old Port Formations, undivided |
| ■ Clinton Group | ■ Pocono Formation |
| ■ Duncannon Member of Catskill Formation | ■ Sherman Creek Member of Catskill Formation |
| ■ Hamilton Group | ■ Spechtly Kopf Formation |
| ■ Irish Valley Member of Catskill Formation | ■ Trimmers Rock Formation |
| ■ Keyser and Tonoloway Formations, undivided | ■ Tuscarora Formation |
| ■ Mauch Chunk Formation | ■ Wills Creek Formation |

Linear Features

- Roads
- Railroads
- - - 69kV Transmission Lines
- 500kV Transmission Line
- - - Municipal Boundaries
- - - Study Area Boundary

Prepared By:

ppl
 PPL Electric Utilities

Map 7
Geology

**Richfield-Dalmatia
 69 kV Tie Line**



Alternative Line Routes

- Route A
- Route B
- Route C

Source:
 PASDA, Snyder County GIS,
 Juniata County GIS and Urban
 Research & Development Corporation



- Legend**
- ✱ Listed National Register Historic Sites
 - 1 - Aline Covered Bridge
 - 2 - East Oriental Covered Bridge (aka. Sheaffer Covered Bridge)
 - 3 - North Oriental Covered Bridge

- Eligible to be Listed National Register Historic Sites
 - 4 - Dauphin County Bridge No. 27
 - 5 - Backus-Leight Dwelling
 - 6 - Herrold, Frederick, House
 - 7 - Herrold, Family Structure No. 3
 - 8 - Herrold-Reichenbach House & Store
 - 9 - Independence School
 - 10 - McKees Half Falls Historic District
 - 11 - Meiser, Frederick, Grist Mill
 - 12 - Pennsylvania Canal, Susquehanna Division
 - 13 - Rine, J.S., House
 - 14 - Saint Johns Church & Cemetery

- Linear Features**
- Roads
 - Railroads
 - 69kV Transmission Lines
 - 500kV Transmission Line
 - - - Municipal Boundaries
 - Study Area Boundary
 - Alternate Routes

Prepared By:

Map 8
Cultural & Historic Features

**Richfield-Dalmatia
 69 kV Tie Line**

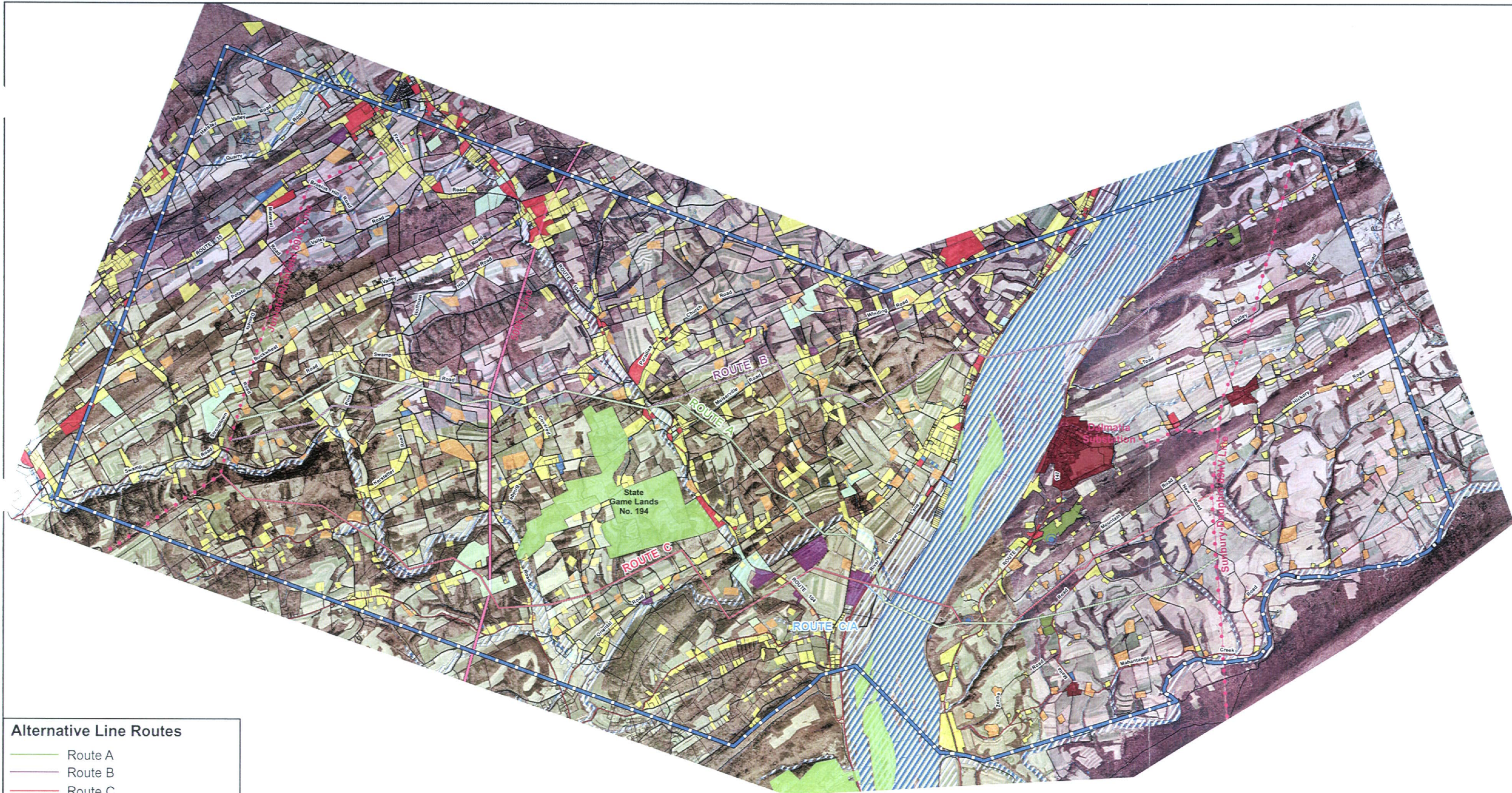

Alternative Line Routes

- Route A
- Route B
- Route C

Source:
PASDA, Snyder County GIS,
Juniata County GIS and Urban
Research & Development Corporation

0 5,000 10,000 Feet

Legend

| | | |
|---|---|---|
| ● Communication Tower | Public/Semi-Public | — · — · Streams |
| Farmstead | Village | Wetlands |
| Residential | Quarry | 100 Year Floodplains |
| Commercial | Industrial | Woodlands |
| Nursery | State Game Lands | |

Linear Features

- Roads
- · — · Railroads
- · — · 69kV Transmission Lines
- · — · 500kV Transmission Line
- - - - Municipal Boundaries
- · — · Study Area Boundary

Prepared By:

Existing Constraints

**Richfield-Dalmatia
69 kV Tie Line**

Attachment

3

**ATTACHMENT 3
 RICHFIELD-DALMATIA 69 kV TIE LINE
 SITING ANALYSIS**

TABLE OF CONTENTS

| <u>SECTION</u> | <u>TOPIC</u> | <u>PAGE</u> |
|-----------------------|---|--------------------|
| I. | INTRODUCTION..... | 1 |
| II. | LINE ROUTE SELECTION | 2 |
| A. | SUMMARY..... | 2 |
| B. | DESCRIPTION OF ALTERNATIVE ROUTE A..... | 4 |
| | West Perry Township..... | 4 |
| | Perry Township..... | 4 |
| | Chapman Township..... | 5 |
| | Susquehanna Township..... | 5 |
| | Lower Mahanoy Township..... | 5 |
| | Substation Connection..... | 6 |
| C. | DESCRIPTION OF ALTERNATIVE ROUTE B..... | 6 |
| | West Perry Township..... | 7 |
| | Perry Township..... | 7 |
| | Chapman Township..... | 7 |
| | Lower Mahanoy Township..... | 8 |
| | Substation Connection..... | 8 |
| D. | DESCRIPTION OF ALTERNATIVE ROUTE C..... | 8 |
| | Monroe Township..... | 9 |
| | Perry Township..... | 9 |
| | Susquehanna Township..... | 9 |
| | Perry Township..... | 10 |
| | Susquehanna Township..... | 10 |
| | Lower Mahanoy Township..... | 10 |
| | Substation Connection..... | 11 |
| E. | LINE ROUTE COMPARISON..... | 11 |
| F. | SELECTION OF PROPOSED LINE ROUTE..... | 15 |
| | Line Length..... | 15 |

| | | |
|------|---|----|
| | Private Rights-of-Way | 16 |
| | Residential..... | 16 |
| | Project Cost..... | 17 |
| | Natural Features..... | 17 |
| | Slopes..... | 17 |
| | Conclusions..... | 18 |
| III. | PREDICTED IMPACTS AND MITIGATING MEASURES OF THE PROPOSED LINE ROUTE..... | 19 |
| A. | LAND USE..... | 19 |
| B. | NATURAL FEATURES..... | 20 |
| C. | THREATENED AND ENDANGERED SPECIES..... | 21 |
| D. | CULTURAL FEATURES..... | 22 |
| E. | COMMUNITY FEATURES..... | 22 |
| IV. | SPECIFIC RIGHT-OF-WAY REQUIREMENTS..... | 23 |
| A. | DESCRIPTION OF RIGHT-OF-WAY REQUIREMENTS..... | 23 |
| B. | STATUS OF RIGHT-OF-WAY NEGOTIATIONS..... | 23 |

LIST OF FIGURES

| | |
|----------|---|
| FIGURE 1 | SITING PROCESS |
| FIGURE 2 | MAPPING AND ANALYSIS PROCEDURE |
| FIGURE 3 | TYPICAL RIGHT-OF-WAY CROSS SECTION |
| FIGURE 4 | TYPICAL RIGHT-OF-WAY CROSS SECTION (AREA OF SUSQUEHANNA RIVER CROSSING) |

MAPS

AERIAL MAPS FOR THE RICHFIELD-DALMATIA 69 kV TIE LINE

ATTACHMENT 3
MAP POCKET

**ATTACHMENT 3
RICHFIELD-DALMATIA 69 kV TIE LINE
SITING ANALYSIS**

I. INTRODUCTION

In determining whether to approve the exercise of the power of eminent domain for the construction of aerial electric lines, the Pennsylvania Public Utility Commission (“Commission”) considers the reasonableness of the route selected. Therefore, PPL Electric Utility Corporation (“PPL Electric”), in siting the line, considered factors set forth in the Commission’s regulations, as well as other factors.

In order to select a reasonable and appropriate route for the proposed Richfield-Dalmatia 69 kV Tie Line and Meiserville 69-12 kV Substation that reflects a proper balance of functional requirements, social and natural environmental factors, and cost considerations PPL Electric conducted an extensive siting analysis. The following steps were followed in making the siting analysis:

First, the project’s functional requirements were used to identify a project Study Area.

Second, a land use and environmental inventory was compiled for the Study Area. Data was gathered and plotted on Maps 1-8, which can be found at the end of Attachment 2 - Study Area Environment section of this Exhibit. A description of each map feature is provided in Section V of Attachment 2.

Third, preliminary line route alternatives were identified using the mapping analysis procedure shown in *Figure 2*. Route alternatives were generated to avoid land use constraints where practical.

Fourth, the project was reviewed with the appropriate municipal and state officials and agencies. Public input was solicited through public meetings and, in conjunction with the

environmental inventory, was used to develop a “constraint” map depicting areas that should be avoided if practical.

Fifth, engineering design criteria were considered. Engineering design is determined by line voltage, current-carrying requirements, and topography.

Sixth, an environmental impact assessment was performed, and PPL Electric estimated right-of-way acquisition and line construction costs for each route alternative. These impacts and costs are shown in Table 1 on Pages 12 and 13.

Seventh, the alternative line routes were compared. The preferred route was selected based on public and governmental input, construction and maintenance impediments, and by analyzing land use and environmental impacts, functional considerations, and cost for each alternative.

The final step was to communicate the preferred route to the public and appropriate municipal, county, state, and federal agencies.

II. LINE ROUTE SELECTION

A. SUMMARY

PPL Electric conducted detailed studies to determine a reasonable and appropriate route to construct a double-circuit 69 kV transmission tie line between PPL Electric’s existing Sunbury-Dauphin 69 kV Transmission Line and Juniata-Richfield 69 kV Transmission Line. The functional considerations for this project limited the project study area to portions of Snyder, Juniata, and Northumberland counties.

The existing Juniata-Richfield 69 kV Transmission Line is located west of the Susquehanna River in Snyder and Juniata counties. The existing Sunbury-

Dauphin 69 kV Transmission Line is located east of the Susquehanna River in Northumberland County. Due to the congested nature of the area in and around the Village of Dalmatia, which is located east of the Susquehanna River, routing opportunities were limited to less developed areas to the north and south of Dalmatia. Residential development along the west bank of the Susquehanna River limited routing opportunities for the Susquehanna River crossing. Finally, avoiding public lands where possible limited routing opportunities to the north and south of State Game Land #194, which is located near the center of the Study Area and west of the Susquehanna River.

After considering the project's functional requirements, the previously identified routing evaluation, and public and governmental input, three alternative routes were selected.

All three routing alternatives, hereinafter referred to as A, B, and C, construct the line in new rights-of-way. The routes traverse portions of Lower Mahanoy, Susquehanna, Chapman, Perry, West Perry, and Monroe Townships. Each of the three alternatives is depicted on the Environmental Inventory Mapping found at the end of the Study Area Environment section and discussed below in more detail. Based on a detailed analysis of all siting factors, PPL Electric selected Route A as the preferred route.

As part of the proposed project, a new 69-12 kV substation and connecting line are required. Both the new substation and the proposed Richfield-Dalmatia 69 kV Tie Line are necessary to provide reliable service in the area. A new transmission tap line is required from the proposed Richfield-Dalmatia Tie Line to connect the new substation to the electrical grid. By siting the substation in close proximity to the planned transmission tie line, the length of the connecting line, and associated impacts on communities and nearby residents, will be minimal.

PPL Electric's proposed substation site will minimize the construction of additional facilities that are required to connect the substation to the electric grid. A 3.61 acre parcel from a larger tract of land, in Susquehanna Township, Juniata County was selected as the preferred substation site. This site is optimal because it is centrally located, and will put the preferred route within close proximity to the preferred substation site.

B. DESCRIPTION OF ALTERNATIVE ROUTE A

Route A is approximately 11.54 miles long, which includes the tap line to the proposed 69-12 kV substation. The line begins at the existing Juniata-Richfield 69 kV Line in West Perry Township, Snyder County and proceeds in a southeasterly direction to its connection point along the existing Sunbury-Dauphin 69 kV Line in Lower Mahanoy Township, Northumberland County. This alternative requires the acquisition of a new right-of-way that is a minimum of 100 feet in width. In the area of the proposed Susquehanna River crossing this alternative requires a 150 foot wide right-of-way.

WEST PERRY TOWNSHIP, SNYDER COUNTY

The initial 0.9 miles of Route A pass through the southeastern portion of West Perry Township. The majority of this section of Route A is farmland, interspersed with wooded property. Road crossings along this section of Route A include Daniels Road and Swamp Road. This section of Route A crosses an unnamed tributary of the West Branch of the Mahantango Creek.

PERRY TOWNSHIP, SNYDER COUNTY

Route A continues approximately 3.9 miles east/southeast through Perry Township, to the Chapman Township border. This section of Route A crosses PPL Electric's existing Juniata-Sunbury 500 kV Transmission Line. There are

several road crossings within this section of Route A, including Pine Swamp Road, Arbogast Church Road, Snake Road, Beidler Road, Covered Bridge Road, Mill Road, and Route 104. This section of Route A crosses Aline Creek, the North Branch of the Mahantango Creek, and four unnamed tributaries. A 600-foot section of this corridor falls within the 100-year floodplain of the North Branch of the Mahantango Creek. Land use along this section is a mix of agricultural and wooded areas. There are some large residential properties and minimal commercial property along this section. Approximately 2.5 miles of this section of Route A is common with Route B.

CHAPMAN TOWNSHIP, SNYDER COUNTY

Route A continues southeast for approximately 2.0 miles crossing a mix of wooded and agricultural land in Chapman Township. This section of Route A crosses three unnamed tributaries of the North Branch of the Mahantango Creek. A 300-foot section of this corridor falls within the 100-year floodplain of the Mahantango Creek near the Snyder and Juniata County borders. Road crossings along this section include Meiserville Road, and Oriental Road.

SUSQUEHANNA TOWNSHIP, JUNIATA COUNTY

Route A continues approximately 1.1 miles southeast through Susquehanna Township to the Lower Mahanoy Township border at the Susquehanna River. As Route A enters into Susquehanna Township it crosses over the Mahantango Creek. Land use along this section is mostly agricultural, with minimal wooded areas. Road crossings in this section include St. Paul Road, Old Trail Road, and Route 11/15.

LOWER MAHANAY TOWNSHIP, NORTHUMBERLAND COUNTY

The final 3.6-mile section of Route A traverses Lower Mahanoy Township. This section spans the Susquehanna River into Lower Mahanoy Township.

Approximately 2,700 feet of this corridor falls within the 100-year floodplain of the Susquehanna River. This area is predominantly farmland, with some wooded areas. Route A crosses a railroad and a tree farm in this section. Additionally, a few residential properties are scattered throughout this section of the route. This section of Route A crosses two unnamed tributaries of the Susquehanna River and three unnamed tributaries of the Mahantango Creek. This section also crosses approximately 500 feet of 100-year floodplain of the Mahantango Creek. Road crossings along this section include Route 147, Malta Road, Adams Road, and Fishery Road. Approximately 0.5 miles of this portion of Route A is common with Route C.

SUBSTATION CONNECTION

In addition to the route described above, one additional single-circuit transmission tap line, approximately 400 feet in length, will be needed to connect Route A to the proposed 69-12 kV substation. This connection will be located in Susquehanna Township, Juniata County. The existing land use in the area of the substation and connecting line is agricultural.

C. DESCRIPTION OF ALTERNATIVE ROUTE B

Route B is approximately 12.49 miles long, which includes the tap line to the proposed 69-12 kV substation. The route begins at the existing Juniata-Richfield 69 kV Line in West Perry Township, Snyder County and proceeds in an east/southeasterly direction to its connection point along the existing Sunbury-Dauphin 69 kV Line in Lower Mahanoy Township, Northumberland County. This alternative would require the acquisition of a new right-of-way that is 100 feet in width.

WEST PERRY TOWNSHIP, SNYDER COUNTY

The initial mile of this alternative passes through the southeastern portion of West Perry Township. The area is mostly wooded, although agricultural areas are interspersed in this section. Road crossings along this section of Route B include Daniels Road and Swamp Road. This section of Route B crosses an unnamed tributary of the West Branch of the Mahantango Creek.

PERRY TOWNSHIP, SNYDER COUNTY

Route B continues approximately 3.8 miles east/southeast through Perry Township to the Chapman Township border. This section crosses PPL Electric's existing Juniata-Sunbury 500 kV Transmission Line. There are several road crossings within this section of Route B, including: Pine Swamp Road, Arbogast Church Road, Snake Road, Beidler Road, Covered Bridge Road, Mill Road, and Route 104. This section of Route B crosses Aline Creek, the North Branch of Mahantango Creek, and four unnamed tributaries. A 500-foot section of this corridor falls within the 100-year floodplain of the North Branch of Mahantango Creek. This section crosses a mix of farmland and woodland. There are also some large residential properties and minimal commercial property along this section. Approximately 2.5 miles of this section of Route B is common with Route A.

CHAPMAN TOWNSHIP, SNYDER COUNTY

Route B enters Chapman Township heading east/southeast for approximately 3.7 miles to the Susquehanna River, which is also the border between Snyder and Northumberland Counties. This section crosses a mix of woodland and farmland. This section of Route B becomes more developed and crosses a commercial property as it approaches the Susquehanna River. This section of Route B crosses

Hoffer Creek and five unnamed tributaries. Road crossings along this section include Meiserville Road, Sawmill Road, Hoffer Road, and Route 11/15.

LOWER MAHANNOY TOWNSHIP, NORTHUMBERLAND COUNTY

The final 3.1 miles of Route B traverse Lower Mahanoy Township. This section starts by crossing the Susquehanna River. The river crossing would be accomplished by placing poles on islands within the river. Approximately 6,200 feet of this corridor fall within the 100-year floodplain of the Susquehanna River. This area is mostly wooded, although the route crosses occasional farmland. There is one railroad crossing in this section. The terrain along and adjacent to this section is very steep. This section of Route B crosses an unnamed tributary of the Susquehanna River. Road crossings along this section include Route 147.

SUBSTATION CONNECTION

In addition to the line section described above, one additional single-circuit transmission tap line, approximately 0.8 miles in length, would be needed to connect Route B to the proposed 69-12 kV substation. This connection would be located in Chapman Township. The connecting line would cross one unnamed tributary of Mahantango Creek. The substation and connecting line would be located in an area of farmland and woodland.

D. DESCRIPTION OF ALTERNATIVE ROUTE C

Route C is approximately 12.07 miles long, which includes the tap line to the planned 69-12 kV substation. The route begins at the existing Juniata-Richfield 69 kV line in Monroe Township and proceeds in a southeasterly direction to its connection point along the existing Sunbury-Dauphin 69 kV line in Lower Mahanoy Township. This alternative would require the acquisition of a new right-of-way that is a minimum of 100 feet in width. In the area of the proposed

Susquehanna River crossing this alternative requires a 150 foot wide right-of-way.

MONROE TOWNSHIP, JUNIATA COUNTY

The initial 1.9 mile section of this alternative passes through the eastern portion of Monroe Township. This section of Route C is mostly wooded, although the route crosses occasional farmland. Road crossings along this section of line include Quaker Run Road and Possum Road. This section of Route C crosses the Quaker Run, and an unnamed tributary of Quaker Run. In addition, this section crosses approximately 1,100 feet of the 100-year floodplain of Quaker Run.

PERRY TOWNSHIP, SNYDER COUNTY

Route C continues approximately 0.6 miles southeast through Perry Township to the Susquehanna Township border. This section contains the first of multiple crossings of the West Branch Mahantango Creek. A 1,100-foot section of this corridor falls within the 100-year floodplain of the West Branch Mahantango Creek. Land use along this section is a mix of agricultural and wooded areas.

SUSQUEHANNA TOWNSHIP, JUNIATA COUNTY

Route C continues approximately 1.5 miles southeast through Susquehanna Township, until the route crosses back into Perry Township. As Route C enters into Susquehanna Township it crosses over the West Branch of the Mahantango Creek for the second time. This section is a mix of wooded and agricultural areas. In addition, this section crosses through a proposed subdivision and existing residential properties. This section of the alternative crosses PPL Electric's existing Juniata-Sunbury 500 kV Transmission Line. Road crossings in this section include Spiggs Hill Road, and State Route 2023. As Route C exits Susquehanna Township and reenters Perry Township the route crosses the West

Branch of the Mahantango Creek for a third time. A 1,000-foot section of this corridor falls within the 100-year floodplain of the West Branch of the Mahantango Creek.

PERRY TOWNSHIP, SNYDER COUNTY

Route C continues approximately 2.0 miles east/southeast through Perry Township until the route crosses back into Susquehanna Township. Route C crosses the West Branch of the Mahantango Creek as it enters Perry Township. This section is a mix of woodland and farmland. In addition, this section crosses through an approved subdivision. This section of Route C crosses four unnamed tributaries of the West Branch of the Mahantango Creek. As Route C exits Perry Township and reenters Susquehanna Township the route crosses the West Branch of the Mahantango Creek for a fourth time. Road crossings in this section include Clark Hill Road, and Oriental Road.

SUSQUEHANNA TOWNSHIP, JUNIATA COUNTY

Route C continues approximately 2.1 miles southeast through Susquehanna Township to the Susquehanna River, which is also the border between Juniata and Northumberland Counties. This section is a mix of woodland and farmland. In addition, this section crosses a small portion of an industrial property. Road crossings in this section include Route 104, Old Trail Road, and Route 11/15. A 1,800 foot section of this corridor falls within the 100-year floodplain of the Susquehanna River.

LOWER MAHANNOY TOWNSHIP, NORTHUMBERLAND COUNTY

The final 3.8-mile section of Route C traverses Lower Mahanoy Township. This section spans the Susquehanna River into the Township. Approximately 3,000 feet of this corridor falls within the 100-year floodplain of the Susquehanna River.

Land use in this area is a mix of farmland and woodland. A railroad and a few large residential properties are crossed in this section. This section of Route C crosses three unnamed tributaries of the Susquehanna River, and two unnamed tributaries of Mahantango Creek. Road crossings along this section include Route 147, Malta Road, and New Road. Approximately 0.5 miles of this section of Route C are common with Route A.

SUBSTATION CONNECTION

In addition to the line sections described above, one additional single-circuit transmission tap line, approximately 550 feet in length, would be needed to connect Route C to the proposed 69-12 kV substation. This connection would be located in Susquehanna Township. The substation and connecting line would be located in an undeveloped area.

E. LINE ROUTE COMPARISON

To compare and evaluate each alternative, it was necessary to quantify the potential impacts associated with each route using the land use and environmental inventory of the Study Area. Not all inventoried features were affected. For example, no schools or cemeteries were crossed. Also, not all features mapped are considered impacts. For example, areas of industrial development are usually considered highly compatible with transmission line construction and operation.

The following table contains a detailed quantitative analysis of the impacts and the estimated cost associated with the proposed transmission tie line for each alternative route. The table also includes the projected impacts and costs associated with the tap line to connect the planned substation to the electrical grid.

TABLE 1
IMPACT ASSESSMENT

| IMPACT CATEGORY | UNITS | ALTERNATIVE ROUTE A | ALTERNATIVE ROUTE B | ALTERNATIVE ROUTE C |
|--|--------------|----------------------------|----------------------------|----------------------------|
| LINE DATA | | | | |
| Tie Line Length | Miles | 11.47 | 11.72 | 11.96 |
| Tap Length | Miles | 0.07 | 0.77 | 0.11 |
| Total Length New Line | Miles | 11.54 | 12.49 | 12.07 |
| Additional Rebuild* | Miles | 1.36 | 0 | 0.69 |
| Properties Crossed by R/W for Tie Line | Number | 69 | 58 | 67 |
| Additional Properties Crossed by R/W for Tap | Number | 0 | 2 | 1 |
| Total Properties Crosses | Number | 69 | 60 | 68 |
| Private R/W Required for Tie Line | Acres | 144 | 142 | 151 |
| Additional Private R/W Required for Tap Line | Acres | 0 | 9.34 | 1.30 |
| Total R/W Required | Acres | 144.00 | 151.34 | 152.30 |
| Project Cost (Est.) | Dollars | 11,643,939 | 11,378,019 | 11,675,791 |
| Tangent Structures (Est.) | Number | 64 | 71 | 73 |
| Angle Structures (Est.) | Number | 24 | 22 | 21 |
| Total Structures (Est.) | Number | 88 | 93 | 94 |
| LINEAR FEATURES | | | | |
| Road Crossings | Number | 20 | 15 | 15 |
| Transmission Line Crossings | Number | 1 | 1 | 1 |
| Railroad Crossings | Number | 1 | 1 | 1 |
| LAND USE | | | | |
| Homes within 500' | Number | 28 | 29 | 24 |
| Subdivisions Crossed (proposed/approved) | Number | 0 | 0 | 2 |

| IMPACT CATEGORY | UNITS | ALTERNATIVE ROUTE A | ALTERNATIVE ROUTE B | ALTERNATIVE ROUTE C |
|--|--------------|----------------------------|----------------------------|----------------------------|
| Agricultural | Miles | 5.82 | 4.36 | 5.73 |
| Commercial | Miles | 0.03 | 0.104 | 0.03 |
| Industrial | Miles | 0 | 0 | 0.09 |
| Historical Structures Within 1000' of Line | Number | 0 | 0 | 0 |
| | | | | |
| SOIL TYPE | | | | |
| Prime Agricultural | Miles | 1.42 | 1.22 | 1.46 |
| Soils w/ High or Seasonally High Water Tables (36" or less)* | Miles | 0.48 | 0.61 | 0.31 |
| Soils w/ Shallow Depth to Bedrock (36" or less) | Miles | 7.49 | 7.75 | 4.44 |
| | | | | |
| NATURAL FEATURES | | | | |
| Wetlands/Hydric Soils** | Acres | 1.89 | 1.5 | 0.23 |
| Floodplain | Miles | 1.49 | 1.27 | 1.74 |
| Stream Crossings | Number | 17 | 16 | 19 |
| Woodlands | Acres | 66.82 | 94.68 | 72.22 |
| Outstanding Natural Areas*** | Miles | 0.54 | 0.82 | 1.1 |
| | | | | |
| SLOPES | | | | |
| 15% and > | Miles | 5.07 | 6.17 | 4.78 |
| ORDINAL SCORE | | 43.5 | 45.5 | 49 |
| RELATIVE MAX.-MIN. SCORE | | 104.22 | 112.84 | 127.21 |
| RELATIVE Z-SCORE | | -2.32 | -0.22 | 2.54 |

* Additional rebuild work required on the existing Sunbury-Dauphin 69 kV Line. This work will be performed from the existing Dalmatia Tap point south to the appropriate alternative tie line point.

** Combination of Hydric Soils and Soils with Hydric Components

*** Natural Heritage Areas

See Appendix D for Impact Assessment Scoring

Three mathematical models were utilized to quantify both social and natural impacts in order to select the preferred line route. The three mathematical models used by PPL Electric are the Ordinal Ranking method, the Relative Max-Min method, and the Relative Z-Score method.

The Ordinal Ranking method is strictly a ranking method which ranks raw data. In this case there were three alternative routes. Therefore, each alternative route was scored one (1) through three (3) based on its ordinal position within each impact category. For example, Alternative Route A crosses the least amount of woodlands and receives a score of one (1). Alternative Route C crosses the second fewest woodland areas and receives a score of two (2). Finally, Alternative Route B crosses the most woodland areas and receives a score of three (3). In the case of a tie between routes, an average score was applied to those routes. The individual scores within each alternative route were then totaled to get an overall score. The lowest overall score indicates the route with the least overall impact. As shown at the end of Table I, Route A had the lowest overall score, indicating that it was the best alternative using the Ordinal Ranking method.

The Relative Max-Min and Relative Z-Score methods assign scores based on the degree of difference between each route within each impact category. The alternative routes were scored based on their relative positions when compared to the other alternative routes. Using the woodlands example from above, Alternative Route A receives the lowest score using both methods. Alternative Route C receives the second lowest score but only scores slightly higher than Alternative Route A. Finally, Alternative Route B scores the highest and is significantly higher than Alternative Routes A and C. This is due to the fact that Alternative Routes A and C cross a similar amount of woodland area, while Alternative Route B crosses a much larger amount of woodland area. The individual scores for each alternative route were then totaled to get an overall

score. The lowest overall score indicates the route with the least overall impact. The formulas for the models are shown below.

Relative Max-Min Formula:

$$\text{Relative Score} = 1 + 9 \left(\frac{X - \text{minimum value}}{\text{maximum value} - \text{minimum value}} \right)$$

Relative Z-Score Formula:

$$\text{Z-Score} = \frac{X - \text{mean value}}{\text{standard deviation}}$$

Under both the Relative Max-Min method and the Relative Z-Score method, Route A had the lowest score, indicating that it is the preferred alternative.

As shown at the end of Table I, Route A has the lowest cumulative impact when calculated using all three standard route evaluation data analysis techniques.

F. SELECTION OF PREFERRED ROUTE

Selecting a preferred route often involves comparing and contrasting disparate features and landscape. It is PPL Electric's goal to select a route that reasonably balances impacts on land use, the environment, cost and functionality. To this end, the Siting Team conducted field reviews with PPL Electric engineering and construction personnel. In addition, PPL Electric consulted extensively with the general public and municipal, county and state officials. The key elements that led PPL Electric to select Route A as the preferred line route are set forth below.

LINE LENGTH

Route B is approximately 12.49 miles long and Route C is approximately 12.07 miles long. At approximately 11.54 miles long, the preferred route (Route A) is

approximately 0.95 and 0.53 miles shorter than the other alternatives, respectively.

PRIVATE RIGHTS-OF-WAY

The required right-of-way for the new Richfield-Dalmatia 69 kV Tie Line is a minimum of 100 feet in width. Alternative Routes A and C require a 150 foot wide right-of-way in the area of their Susquehanna River crossings. This is to accommodate the structures needed for a single span River crossing, and to accommodate a second-circuit in the future. Route B crosses the River through multiple spans, therefore single shaft steel poles can be used, which will accommodate a future second circuit within a 100 foot right-of-way.

Private rights-of-way for Alternative Route B is estimated at 151.34 acres from 60 properties. Alternative Route C requires approximately 152.30 acres of private rights-of-way from 68 properties. Alternative Route A requires the least amount of private rights-of-way. Route A requires 144.00 acres from 69 properties.

RESIDENTIAL

Intrusions into residential areas are avoided to the extent feasible. However, development patterns in the Study Area make it impossible to avoid all homes. The number of homes within 500 feet of the centerline of each alternative was compiled. Alternative Route C had 24 homes within 500 feet, which was the fewest of the three alternatives. Alternative Route A comes within 500 feet of 28 homes. Alternative Route B comes within 500 feet of the most homes, 29.

PROJECT COST

The cost of each alternative is essentially the same, and the margin between the alternatives is within the estimating error. The cost to construct Alternative Route B was estimated to be \$11.38 million, the least expensive of the alternatives. The cost for Alternative Routes A and C are \$11.64 million and \$11.68 million, respectively.

NATURAL FEATURES

Several rivers, creeks, and unnamed tributaries are within the Study Area. These have formed floodplains and wetlands. All three alternatives impact natural features. Alternative Route A crosses the largest acreage of wetlands at an estimated 1.89 acres but requires the least amount of tree clearing at 66.82 acres. The impact of Route A on the wetlands will be minimal because the wetlands can be spanned. Alternative Route B would have the greatest impact on the Susquehanna River due to the fact that construction activities would take place in the river. Alternative Route A and Alternative Route C do not require construction activities in the river. Alternative Route C crosses the most streams and the most outstanding natural areas.

SLOPES

Steep slopes can cause many problems during construction and subsequent line maintenance and are avoided whenever practical. Problems associated with construction on steep slopes include the potential for soil erosion and the lack of post-construction re-vegetation. Steeper slopes can drive up project costs for road building and tree clearing, and create difficulties in handling and setting structures. The rolling terrain throughout the Study Area makes avoidance of steep slopes impossible. Alternative Route B traverses approximately 6.17 miles of slopes greater than 15%, which is the most of the three alternatives.

Alternative Route A traverses approximately 5.07 miles and Alternative Route C traverses approximately 4.78 miles of slopes greater than 15%.

CONCLUSIONS

PPL Electric gave primary consideration to the following facts in selecting Alternative Route A:

- All three alternatives cross the Susquehanna River. The preferred alternative river crossing is the shortest of the three alternatives. In addition, the preferred alternative crossing can be accomplished with a single span which does not require construction activities in the river, as compared to Alternative Route B. A single span crossing limits the impacts to the Susquehanna River and reduces permitting requirements. A single span crossing is more accessible and easier to maintain, which results in shorter repair times and reduced outage durations.
- Constructing the line along the preferred route results in the least amount of impact to outstanding natural areas.
- The preferred route is the shortest route and encumbers the least acreage with new rights-of-way.
- Tree clearing, stream crossings, and steep slopes along and adjacent to the preferred alternative are the least restrictive. This results in less complicated and safer work environments during construction and maintenance. It also allows for easier access which results in shorter repair times and reduced outage durations.
- Route A scores the best when three standard route evaluation data analysis techniques (Ordinal Method, Relative Max.-Min. Method, and Relative Z-Score Method) are applied to the Impact Assessment (Table I pages 12 and 13) of the alternative routes. These analyses balance all of the factors considered in Table I.

III. PREDICTED IMPACTS AND MITIGATING MEASURES OF THE PREFERRED LINE ROUTE

The following is a discussion of the predicted impacts of the proposed Richfield-Dalmatia 69 kV Tie Line.

PPL Electric is working diligently with cooperating property owners to locate the line to minimize the impact on existing and future land use. Where impacts are unavoidable, mitigating factors will be employed. PPL Electric will acquire and comply with any required soil erosion and sedimentation control permit conditions. In addition, any required permits will be obtained from the Pennsylvania Department of Environmental Protection and the United States Army Corps of Engineers prior to construction, and PPL Electric will comply with all conditions placed on the permits.

A. LAND USE

The proposed route was analyzed in relation to current and future land use. Some impact on existing and future land use is unavoidable. The rights-of-way required for the proposed transmission line will preclude certain uses, such as locating buildings or swimming pools within the easement. PPL Electric's Encroachment Policy, however, allows for compatible land use on transmission line easements. PPL Electric is working with cooperating property owners to locate the line to minimize the impact on existing and future land uses. Property owners will be compensated at present land values for the rights-of-way.

Approximately half of the preferred line route crosses property which is currently utilized for agricultural purposes. PPL Electric is working to minimize the number of poles located in farmed fields. In addition, poles which must be placed in farmed fields will be set on foundations, if possible, to provide the necessary

structural support. This engineering practice will limit the need for guy wires in fields, which would further impeded farming operations.

The proposed transmission line will be designed to avoid conflicts with communication towers and other utilities found in the Study Area.

B. NATURAL FEATURES

Approximately 66.82 acres of vegetation management is required to ensure the safe and reliable operation of the proposed line. Selective clearing measures, as outlined in PPL Electric's "Specifications for Initial Clearing and Control of Vegetation On or Adjacent to Electric Line Right-of-Way through Use of Herbicides, Mechanical, and Hand Clearing Techniques", will preserve compatible species of low growing trees, shrubs and grasses where practical. Any herbicides utilized on the right-of-way will be EPA-approved and will be applied selectively in accordance with all label instructions. Additionally, some property owners along the line route have requested that PPL Electric limit the use of spraying on their properties. PPL Electric has agreed to these requests.

National Wetland Inventory mapping and Hydric Soils mapping indicate several wetland areas along the proposed line route. A certified wetlands expert will verify and delineate any wetland areas along the route. Wetland areas will be surveyed and added to the construction drawings. Wherever possible, suitable upland areas will be utilized for the placement of structures and access roads to avoid or minimize wetland impacts. All required permits will be obtained from the Pennsylvania Department of Environmental Protection and the United States Army Corps of Engineers prior to construction.

The proposed line route crosses the Susquehanna River, Mahantango Creek, and several unnamed tributaries. Impacts to these watercourses are expected to be minimal, as they will be spanned by the proposed transmission line.

Flood prone areas are found adjacent to the watercourses along the preferred line route. Avoidance of flood prone areas is not possible due to the drainage patterns associated with the various watercourses. Spanning all flood prone areas is not possible. Any structures located within floodplains will utilize special foundations due to their size to ensure the long-term integrity of the structures during floods. PPL Electric will obtain all required permits prior to the start of construction in flood prone areas.

C. THREATENED AND ENDANGERED SPECIES

The United States Fish and Wildlife Service notes that this project is within the range of the Indian bat (*Myotis sodalis*). PPL Electric has retained the services of biologist Richard Mellon, of Mellon Biological Services, to provide additional information which the US Fish and Wildlife Service has requested to further evaluate the potential impact.

Correspondence from the Department of Conservation and Natural Resources (“DCNR”) indicates that the Jeweled shooting star (*Dodecatheon radicum*) may inhabit a portion of the project area. Mr. Mellon will perform a survey at the appropriate time of year to confirm the status of this plant in the project area.

Correspondence from the Pennsylvania Fish and Boat Commission (“PFBC”) indicates a potential impact to a rare and protected fresh water mussel species in the area of the Susquehanna River. The PFBC has requested additional information to further evaluate potential impacts to the fresh water mussel. Mr. Mellon is working with the PFBC and will provide the additional information that has been requested.

Any conflicts with the above species of concern will be resolved prior to the start of construction.

D. CULTURAL FEATURES

Aline Covered Bridge, which is listed on the National Register of Historic Places, is located at the intersection of Route 104 and Aline Church Road in Perry Township, Snyder County. The proposed line route will pass approximately 1,200 feet from this site. Impacts to the property are of a visual nature. The visual impact is not expected to be significant due to the distance from the preferred line route. In addition, the existing land use in this area is primarily commercial and industrial.

PPL Electric has also consulted with the Pennsylvania Historical and Museum Commission (“PHMC”). PHMC has requested that PPL Electric conduct a geomorphologic study in the area of the Mahantango Creek and the Susquehanna River. In addition, PHMC has requested that archaeological investigations be performed at all proposed pole locations to verify the extent of known sites and to locate new sites. PPL Electric will arrange to have these assessments performed by qualified individuals. Construction in these areas will not begin until the PHMC is satisfied that any sensitive sites have been fully investigated and potential impacts have been mitigated. The presence of any archaeological sites will not, however, cause PPL Electric to reroute the line such that the condemnation of the property that is the subject of this proceeding would not be required.

E. COMMUNITY FEATURES

There are several schools, day care centers, churches, and cemeteries within the Study Area. St. Paul’s Church, and a cemetery located on the same property, are approximately 285 feet from the edge of the proposed transmission line right-of-way. They are the closest features of this nature to the proposed line route. The

Church and cemetery are located in close proximity to an existing industrial facility. Therefore, impacts to these features are anticipated to be minimal.

IV. SPECIFIC RIGHT-OF-WAY REQUIREMENTS

A. DESCRIPTION OF RIGHT-OF-WAY REQUIREMENTS

The right-of-way width is determined by structure type, design tensions, span length and conductor “blowout” (the distance the wires are moved by a crosswind). PPL Electric’s standard right-of-way width for a 69 kV transmission line is 100 feet. The proposed line will be within a new right-of-way that is a minimum of 100 feet wide. In the area of the Susquehanna River crossing, the new right-of-way will be 150 feet wide.

A cross-section of the proposed right-of-way is illustrated in Figures 3 and 4. The aerial map of the proposed line route shows the location of the proposed route, identifies the properties that are traversed by the route, and shows right-of-way widths. While the line was originally planned to cross 69 properties, due to minor changes during right-of-way negotiations with property owners, 71 different properties will be crossed.

B. STATUS OF RIGHT-OF-WAY NEGOTIATIONS

In total new rights-of-way and easements are being negotiated with 54 different property owners, across 71 different properties. Agreements have been secured from 43 of the 54 property owners. PPL Electric continues to negotiate with the unsigned property owners. PPL Electric anticipates that some of these negotiations will be unsuccessful. In the event that PPL Electric cannot reach agreement with the remaining property owners, the Company will request that the Commission grant authority for PPL Electric to condemn easements across any unsigned properties.

Tax Parcel: 29-00-105-59

Deed Book and Page: 1019 - 618

Name: Ronald Mace & Dianne Mace

Address: 584 Malta Road
Dalmatia, PA 17017

Owner Contact Number: 570-758-1567

PPL Electric's Most Recent Compensation Offer: \$ 19,870.00

Comparable Land Value Report Amount (Report prepared by a third party PA State Licensed Appraiser): \$ 19,870.00

Amount of Rights-of-Way to be secured via condemnation: 3.82 Acres

What is (are) the primary reason(s) an agreement has not been reached:

Several attempts to negotiate with Mr. and Mrs. Mace have occurred over the past nine months. The Maces are against the line route crossing their property, and would prefer a route to the north which does not cross their property. The Maces have been unwilling to meet formally with PPL Electric to discuss compensation. Therefore, PPL Electric sent the Maces a compensation offer of \$19,870 via certified mail. Mr. Mace has indicated that he believes PPL Electric's offer is too low, and that he believes a fair value for the right of way is \$250,000. PPL Electric's offer is based on a comparable land value report which was prepared for the Company by a third party appraiser. The comparable land value report provided a range of between \$2,000 and \$4,500 per acre owned by the Maces, depending on how the land was used. PPL Electric offered the Maces \$5,500 per acre for the cleared agricultural land, and \$4,500 per acre for the wooded land. PPL Electric also valued a portion of the property as a residential building lot, and valued that lot at \$6,000 based on the comparable land value report. PPL Electric's offer exceeded the comparable land value report value range for the land, however Mr. Mace has refused to negotiate. Mr Mace's offer of \$250,000 does not reflect the actual value of the land, and is unreasonable. Therefore, PPL Electric has been unable to reach an agreement with the Maces.

SITING PROCESS

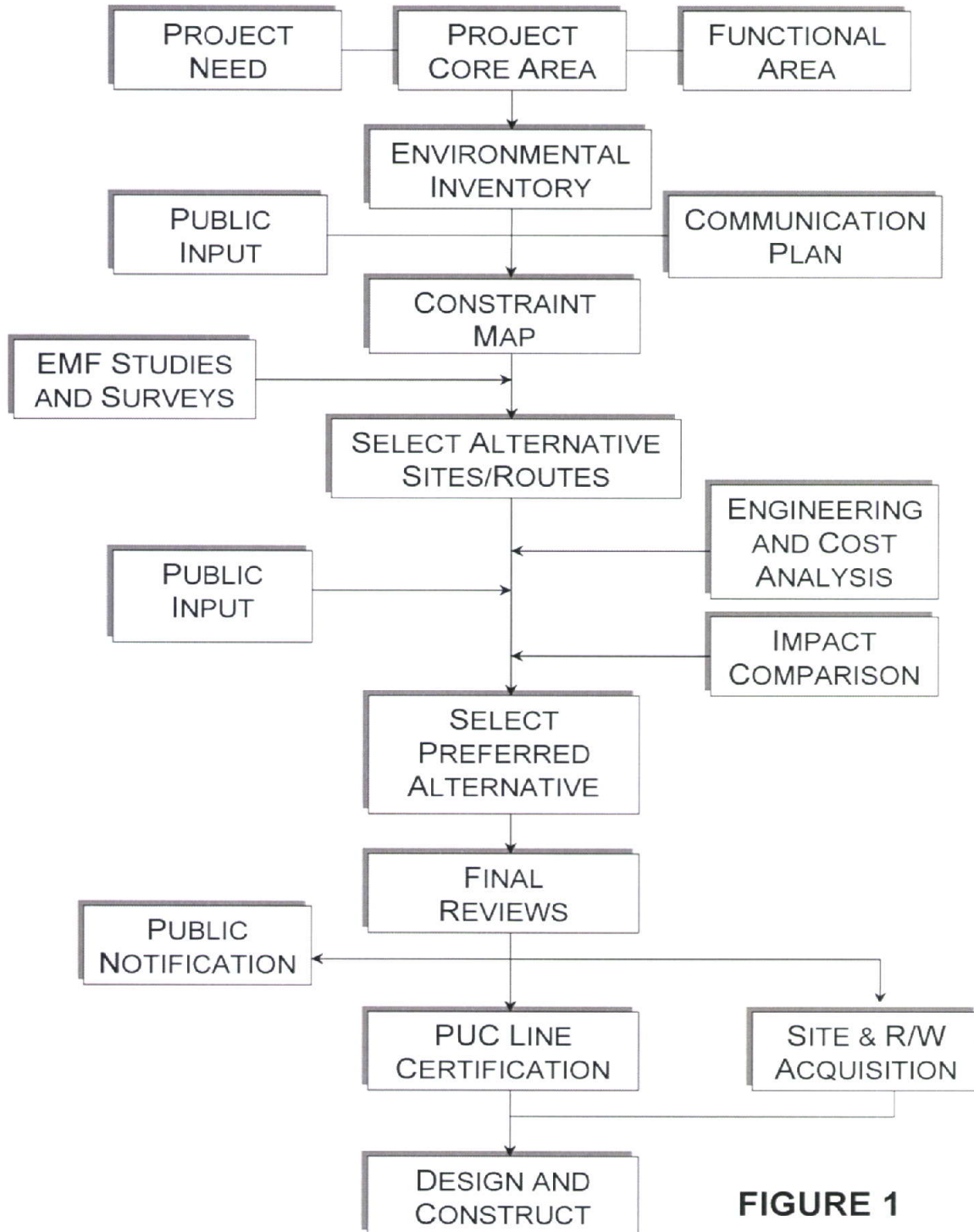

FIGURE 1

MAPPING AND ANALYSIS PROCEDURE

COMBINING OVERLAYS FOR
PPL ELECTRIC UTILITIES
TRANSMISSION SITING PROCESS

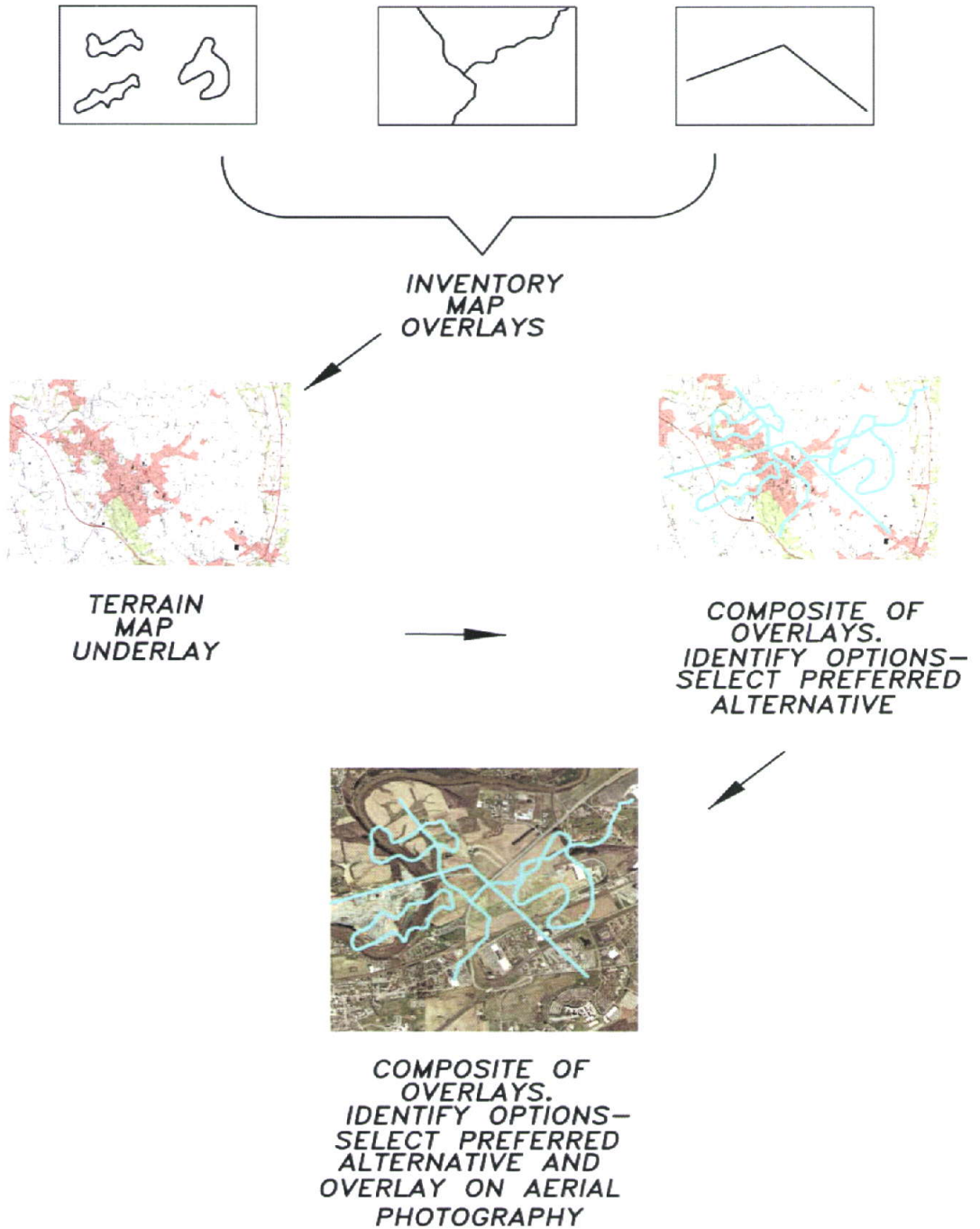
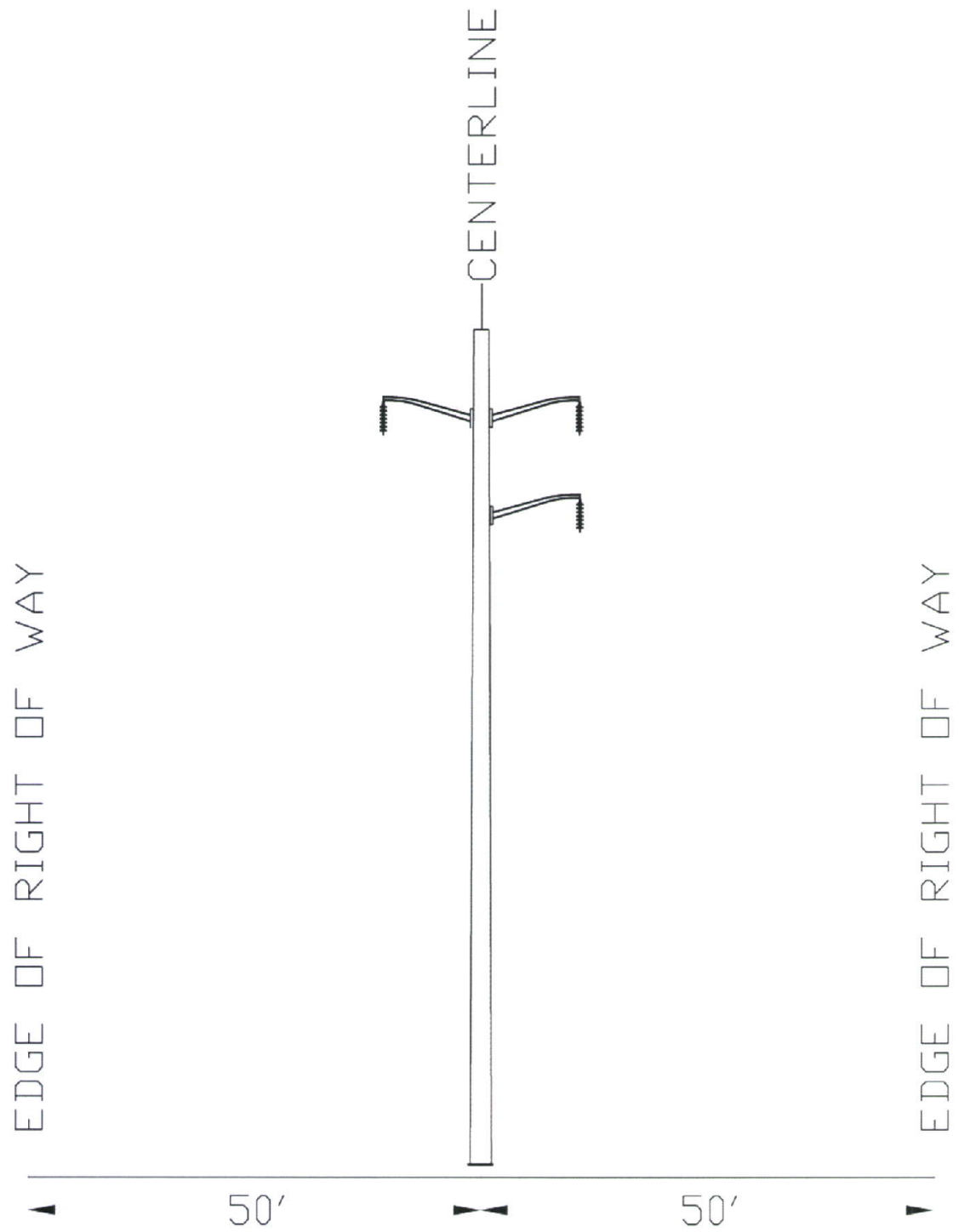

FIGURE 2



TYPICAL RIGHT-OF-WAY CROSS SECTION

Not to Scale

FIGURE 3

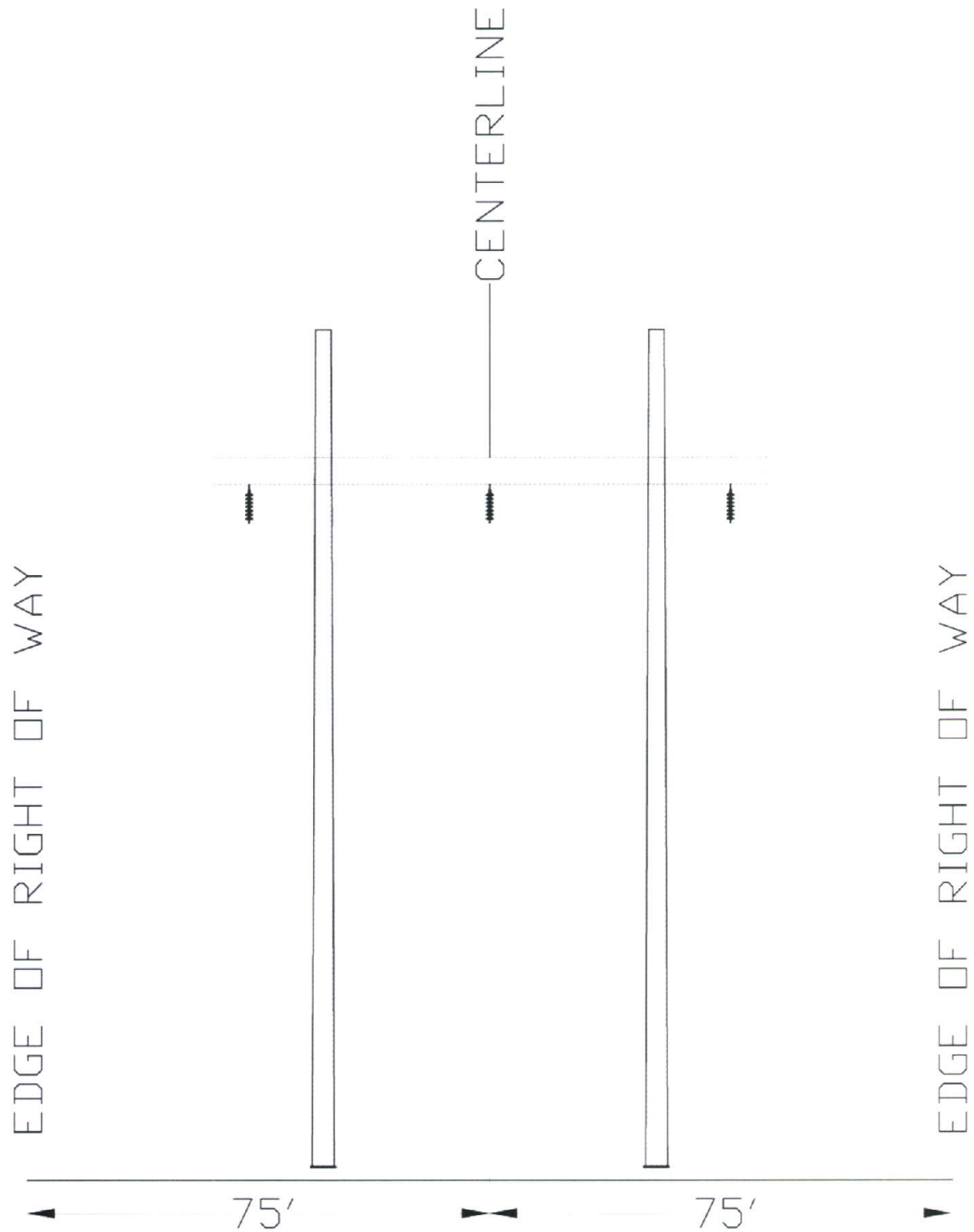

TYPICAL RIGHT-OF-WAY CROSS SECTION
 (AREA OF SUSQUEHANNA RIVER CROSSING)

Not to Scale

FIGURE 4



LEGEND

| | |
|---------------------------------|--|
| PROPOSED CENTERLINE OF NEW LINE | |
| PROPOSED RIGHT OF WAY | |
| PROPERTY LINES | |
| EXISTING TRANSMISSION LINE | |
| STATE GAME LAND BOUNDARY | |
| PROPOSED SUBSTATION LOCATION | |

ATTACHMENT 3

AERIAL ATTACHMENT
SHEET 1 OF 3

RICHFIELD-DALMATIA 69 kV TIE LINE
SNYDER, JUNIATA, AND NORTHUMBERLAND COUNTIES, PA.

SCALE 1" = 1,200'

PREPARED BY:
PPL ELECTRIC UTILITIES CORP.
PPL ELECTRIC UTILITIES

| Property # | Property Owner |
|------------|-------------------------------|
| 1 | ROBERT S. KERSTETTER |
| 2 | ROBERT F. & SARAH S. TROUP |
| 3 | JAMES H. & STACEY L. TROUP |
| 4 | DAVID C. & SANDRA L. COTTRELL |
| 5 | CURTIS S. & DORI D. DIETZ |
| 6 | BENJAMIN A. HOFFMAN |
| 7 | WILMER S. & KATHY S. HORST |
| 8 | MARLIN A. & ANNA H. MARTIN |
| 9 | MICHAEL V. WENDT |
| 10 | CATHY A. MCCALIPS |
| 11 | SIDNEY C. & SUSAN M. HOFFMAN |
| 12 | JOSEPH L. & MARTHA L. BEIDLER |
| 13 | JARED I. MAST |
| 14 | JAMES H. & DONNA L. MAST |
| 15 | CLYDE L. & ADDIE L. BEIDLER |
| 16 | GENE & RACHEL A. NACE |
| 17 | LEONARD M. & NORMA J. SEIBEL |
| 18 | THOMAS B. & DONNA E. BUCHER |
| 19 | TERRY L. VILLOV |
| 20 | SAMUEL & ROSE ALKER |



- LEGEND**
- PROPOSED CENTERLINE OF NEW LINE —
 - PROPOSED RIGHT OF WAY —
 - PROPERTY LINES —
 - EXISTING TRANSMISSION LINE —
 - STATE GAME LAND BOUNDARY —
 - PROPOSED SUBSTATION LOCATION —

ATTACHMENT 3

AERIAL ATTACHMENT
SHEET 2 OF 3

RICHFIELD-DALMATIA 69 kV TIE LINE
SNYDER, JUNIATA, AND NORTHUMBERLAND COUNTIES, PA.

SCALE 1" = 1,200'

 PREPARED BY:
PPL ELECTRIC UTILITIES CORP.
PPL ELECTRIC UTILITIES

| Property # | Property Owner |
|------------|---------------------------------|
| 15 | CLYDE L. & ADDIE L. BEIDLER |
| 16 | GENE & RACHEL A. NACE |
| 17 | LEONARD N. & NORMA J. SEIBEL |
| 18 | THOMAS D. & DONNA E. BUCHER |
| 19 | TERRY L. VILLOV |
| 20 | SAMUEL & ROSE AUER |
| 21 | PAUL G. & RACHAEL S. AUER |
| 22 | GARY G. & MARCELLA M. BRUBAKER |
| 23 | NORMAN M. & JANET A. BRUBAKER |
| 24 | MARTIN L. & VIRGINIA K. BELLMAN |
| 25 | GLADY'S M. STAUFFER |
| 26 | NORMAN M. & JANET A. BRUBAKER |
| 27 | MERLE S. & ALICE V. BRUBAKER |
| 28 | MARLUD S. & ANNA MARY MEISER |
| 29 | DANNY A. CRAWFORD |
| 30 | GARRET A. GELNET |
| 31 | LARRY M. & LAURA G. STRAWSER |
| 32 | ARLENE & WALTER L. STUCK |
| 33 | RUTH, ANNA, & SADDIE AUER |
| 34 | DALE & APRIL SHORR |
| 35 | JOHN B. & ESTHER S. MARTIN |
| 36 | LEONARD V. & RUTH S. STRAWSER |
| 37 | ANTHONY VAUGHN |
| 38 | MARVIN ROGER & LEDNA HESS |

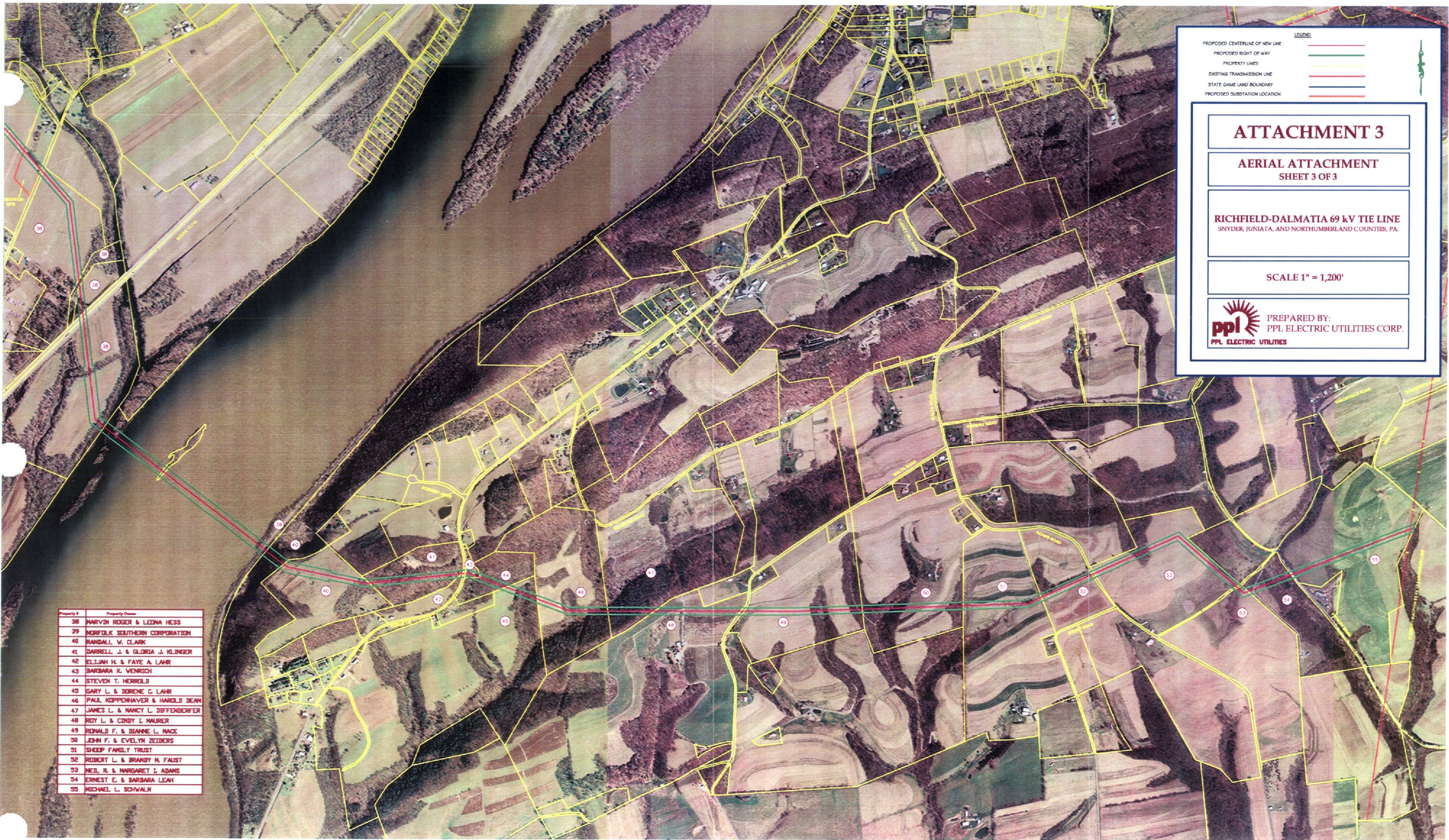

LEGEND

| | |
|---------------------------------|--|
| PROPOSED CENTERLINE OF NEW LINE | |
| PROPOSED RIGHT OF WAY | |
| PROPERTY LINES | |
| DISTING TRANSMISSION LINE | |
| STATE GAME LAND BOUNDARY | |
| PROPOSED SUBSTATION LOCATION | |

ATTACHMENT 3

AERIAL ATTACHMENT
SHEET 3 OF 3

RICHFIELD-DALMATIA 69 kV TIE LINE
SNYDER, JUNIATA, AND NORTHUMBERLAND COUNTIES, PA.

SCALE 1" = 1,200'

 PREPARED BY:
PPL ELECTRIC UTILITIES CORP.
PPL ELECTRIC UTILITIES

| Property # | Property Owner |
|------------|----------------------------------|
| 38 | MARVIN ROGER & LEONA HESS |
| 39 | NORFOLK SOUTHERN CORPORATION |
| 40 | RANDALL W. CLARK |
| 41 | DARRELL J. & GLORIA J. KLINGER |
| 42 | ELIJAH H. & FAYE A. LAHR |
| 43 | BARBARA K. VENRICH |
| 44 | STEVEN T. HORROLD |
| 45 | GARY L. & DORNE C. LAHR |
| 46 | PAUL KOPPENHAVER & HAROLD DEAN |
| 47 | JAMES L. & NANCY L. DIFFENDERFER |
| 48 | ROY L. & CINDY I. MAURER |
| 49 | RONALD F. & DIANNE L. MACE |
| 50 | JOHN F. & EVELYN ZEIDERS |
| 51 | SHOOP FAMILY TRUST |
| 52 | ROBERT L. & BRANDY M. FAUST |
| 53 | NEIL R. & MARGARET I. ADAMS |
| 54 | ERNEST E. & BARBARA LEAH |
| 55 | MICHAEL L. SCHWALM |

Attachment 4

**ATTACHMENT 4
 RICHFIELD-DALMATIA 69 kV TIE LINE
 IMPACT ASSESSMENT SCORING**

| ORDINAL METHOD IMPACT CATEGORY | ORDINAL SCORE | | |
|--|---------------|------------|------------|
| | ROUTE A | ROUTE B | ROUTE C |
| LINE DATA | | | |
| Line Length | | | |
| Tap Length | | | |
| Total Length New Line | 1 | 3 | 2 |
| Additional Rebuild | | | |
| Properties Crossed by R/W for Tie Line | | | |
| Additional Properties Crossed by R/W for Tap | | | |
| Total Properties Crossed | 3 | 1 | 2 |
| Private R/W Required for Tie Line | | | |
| Additional Private R/W Required for Tap Line | | | |
| Total R/W Required | 1 | 2 | 3 |
| Project Cost (Est.) | 2 | 1 | 3 |
| Tangent Structures (Est.) | | | |
| Angle Structures (Est.) | | | |
| Total Structures (Est.) | 1 | 2 | 3 |
| LINEAR FEATURES | | | |
| Road Crossings | 3 | 1.5 | 1.5 |
| Transmission Line Crossings | 2 | 2 | 2 |
| Railroad Crossings | 2 | 2 | 2 |
| LAND USE | | | |

| | | | |
|--|--------------------|--------------------|--------------------|
| Homes within 500' | 2 | 3 | 1 |
| Subdivisions Crossed (proposed/approved) | 1.5 | 1.5 | 3 |
| Agricultural | 3 | 1 | 2 |
| Commercial | 1.5 | 3 | 1.5 |
| Industrial | 1.5 | 1.5 | 3 |
| Historical Structures Within 1000' of Line | 2 | 2 | 2 |
| SOIL TYPE | | | |
| Prime Agricultural | 2 | 1 | 3 |
| Soils w/ High or Seasonally High Water Tables (36" or less)* | 2 | 3 | 1 |
| Soils w/ Shallow Depth to Bedrock (36" or less) | 2 | 3 | 1 |
| NATURAL FEATURES | | | |
| Wetlands/Hydric Soils | 3 | 2 | 1 |
| Floodplain | 2 | 1 | 3 |
| Stream Crossings | 2 | 1 | 3 |
| Woodlands | 1 | 3 | 2 |
| Outstanding Natural Areas** | 1 | 2 | 3 |
| SLOPES | | | |
| 15% and > | 2 | 3 | 1 |
| TOTAL SCORE | 43.5 | 45.5 | 49 |
| | 1 | 2 | 3 |
| | ROUTE A | ROUTE B | ROUTE C |

| RELTAIVE MAX.-MIN. METHOD | RELATIVE SCORE | | |
|--|----------------|------------|------------|
| IMPACT CATEGORY | ROUTE A | ROUTE B | ROUTE C |
| LINE DATA | | | |
| Tie Line Length | | | |
| Tap Length | | | |
| Total Length New Line | 1.00 | 10.00 | 6.02 |
| Additional Rebuild | | | |
| Properties Crossed by R/W for Tie Line | | | |
| Additional Properties Crossed by R/W for Tap | | | |
| Total Properties Crosses | 10.00 | 1.00 | 9.00 |
| Private R/W Required for Tie Line | | | |
| Additional Private R/W Required for Tap Line | | | |
| Total R/W Required | 1.00 | 8.96 | 10.00 |
| Project Cost (Est.) | 9.04 | 1.00 | 10.00 |
| Tangent Structures (Est.) | | | |
| Angle Structures (Est.) | | | |
| Total Structures (Est.) | 1.00 | 8.50 | 10.00 |
| LINEAR FEATURES | | | |
| Road Crossings | 10.00 | 1.00 | 1.00 |
| Transmission Line Crossings | 1.00 | 1.00 | 1.00 |
| Railroad Crossings | 1.00 | 1.00 | 1.00 |
| LAND USE | | | |
| Homes within 500' | 8.20 | 10.00 | 1.00 |
| Subdivisions Crossed (proposed/approved) | 1.00 | 1.00 | 10.00 |

| | | | |
|--|--------------------------|--------------------------|--------------------------|
| Agricultural | 10.00 | 1.00 | 9.45 |
| Commercial | 1.00 | 10.00 | 1.00 |
| Industrial | 1.00 | 1.00 | 10.00 |
| Historical Structures Within 1000' of Line | 1.00 | 1.00 | 1.00 |
| SOIL TYPE | | | |
| Prime Agricultural | 8.50 | 1.00 | 10.00 |
| Soils w/ High or Seasonally High Water Tables (36" or less)* | 6.10 | 10.00 | 1.00 |
| Soils w/ Shallow Depth to Bedrock (36" or less) | 9.29 | 10.00 | 1.00 |
| NATURAL FEATURES | | | |
| Wetlands/Hydric Soils | 10.00 | 7.89 | 1.00 |
| Floodplain | 5.21 | 1.00 | 10.00 |
| Stream Crossings | 4.00 | 1.00 | 10.00 |
| Woodlands | 1.00 | 10.00 | 2.74 |
| Outstanding Natural Areas** | 1.00 | 5.50 | 10.00 |
| SLOPES | | | |
| 15% and > | 2.88 | 10.00 | 1.00 |
| TOTAL SCORE | 104.22 | 112.84 | 127.21 |
| | 1 | 2 | 3 |
| | <u>ROUTE</u> A | <u>ROUTE</u> B | <u>ROUTE</u> C |

| RELTAIVE Z-SCORE METHOD | Z-SCORE | | |
|--|--------------------|--------------------|--------------------|
| | <u>ROUTE A</u> | <u>ROUTE B</u> | <u>ROUTE C</u> |
| IMPACT CATEGORY | | | |
| LINE DATA | | | |
| Tie Line Length | | | |
| Tap Length | | | |
| Total Length New Line | -1.04 | 0.96 | 0.08 |
| Additional Rebuild | | | |
| Properties Crossed by R/W for Tie Line | | | |
| Additional Properties Crossed by R/W for Tap | | | |
| Total Properties Crosses | 0.68 | -1.15 | 0.47 |
| Private R/W Required for Tie Line | | | |
| Additional Private R/W Required for Tap Line | | | |
| Total R/W Required | -1.15 | 0.47 | 0.68 |
| Project Cost (Est.) | 0.48 | -1.15 | 0.67 |
| Tangent Structures (Est.) | | | |
| Angle Structures (Est.) | | | |
| Total Structures (Est.) | -1.14 | 0.41 | 0.73 |
| LINEAR FEATURES | | | |
| Road Crossings | 1.15 | -0.58 | -0.58 |
| Transmission Line Crossings | 0.00 | 0.00 | 0.00 |
| Railroad Crossings | 0.00 | 0.00 | 0.00 |
| LAND USE | | | |
| Homes within 500' | 0.38 | 0.76 | -1.13 |
| Subdivisions Crossed (proposed/approved) | -0.58 | -0.58 | 1.15 |

| | | | |
|--|--------------|--------------|--------------|
| Agricultural | 0.63 | -1.15 | 0.52 |
| Commercial | -0.58 | 1.15 | -0.58 |
| Industrial | -0.58 | -0.58 | 1.15 |
| Historical Structures Within 1000' of Line | | | |
| SOIL TYPE | | | |
| Prime Agricultural | 0.41 | -1.14 | 0.73 |
| Soils w/ High or Seasonally High Water Tables (36" or less)* | 0.09 | 0.95 | -1.04 |
| Soils w/ Shallow Depth to Bedrock (36" or less) | 0.51 | 0.65 | -1.15 |
| NATURAL FEATURES | | | |
| Wetlands/Hydric Soils | 0.79 | 0.34 | -1.13 |
| Floodplain | -0.04 | -0.98 | 1.02 |
| Stream Crossings | -0.22 | -0.87 | 1.09 |
| Woodlands | -0.75 | 1.14 | -0.38 |
| Outstanding Natural Areas** | -1.00 | 0.00 | 1.00 |
| SLOPES | | | |
| 15% and > | -0.37 | 1.13 | -0.76 |
| TOTAL SCORE | -2.32 | -0.22 | 2.54 |
| | 1 | 2 | 3 |
| | <u>ROUTE</u> | <u>ROUTE</u> | <u>ROUTE</u> |
| | <u>A</u> | <u>B</u> | <u>C</u> |

Attachment

5

THIS INDENTURE

MADE the 19th day of September in the year nineteen hundred and ninety-five (1995),

BETWEEN JOHN F. ZEIDERS and EVELYN M. ZEIDERS, husband and wife, of the Township of Lower Mahanoy, County of Northumberland and Commonwealth of Pennsylvania, "Grantors", hereinafter called Parties of the First Part,

AND

RONALD F. MACE and DIANNE L. MACE, husband and wife, of the Township of Lower Mahanoy, County of Northumberland and Commonwealth of Pennsylvania, AS TENANTS BY THE ENTIRETIES, "Grantees", hereinafter called Parties of the second part, WITNESSETH, That said parties of the first part, for and in consideration of the sum of One (\$1.00) Dollars lawful money of the United States of America, well and truly paid by the said parties of the second part to the said parties of the first part, at and before the sealing and delivery of these presents, the receipt whereof is hereby acknowledged have granted, bargained, sold, aliened, enfeoffed, released, conveyed and confirmed, and by these presents do grant, bargain, sell, alien, enfeoff, release, convey and confirm unto the said parties of the second part, their heirs and assigns, as tenants by the entireties,

ALL THAT CERTAIN messuage or tenements and tracts of land situate in Lower Mahanoy Township, County of Northumberland and Commonwealth of Pennsylvania, bounded and described as follows, to wit:

BEGINNING at a stone corner; THENCE by land or formerly of Stephen C. Witmer (formerly Earl Long), NORTH EIGHTY (80) DEGREES WEST, SEVEN (7) PERCHES to stone; NORTH THIRTEEN (13) DEGREES WEST THIRTY-NINE AND SIX TEHNTHS (39.6) PERCHES to stone; NORTH FORTY-ONE AND ONE-FOURTH (41 ¼) DEGREES EAST THIRTY-NINE AND TWO TENTHS (39.2) PERCHES to stone; NORTH SEVEN AND THREE FOURTH (7 ¾) DEGREES EAST, TWENTY AND FOUR TENTH (20.4) PERCHES to stone; TEHNCE by land now or formerly of George Long, NORTH SIXTY-ONE (61) DEGREES EAST, SEVENTY-FIVE AND SECEN TENTH (75.7) PERCHES to stone in public road; THENCE by land now or formerly of Carmey Schaffner, NOTH SIXTY-THREE (63) DEGREES EAST TWENTY (20) PERCHES to stone in said road; THENCE by land now or formerly of John F. Zeiders (formerly John M. Zeiders) due SOUT SIXTY-EIGHT AND TWO TENTHS (68.2) PERCHES to stone; SOUTH TWENTY-THREE AND ONE-HALF (23 ½) DEGREES EAST THIRTY-ONE (31) PERCHES to stone; THENCE by land now or formerly of Serene Witmer SOUTH SEVENTY-SEVEN AND ONE-HALF (77 ½) DEGREES WEST, ONE HUNDRED ELEVEN AND SIX TENTHS (111.6) PERCHES to stone; SOUTH SEVEN AND THREE FOURTH (7 ¾) DEGREES WEST, THIRTEEN AND EIGHT TENTHS (13.8) PERCHES to the place of BEGINNING. CONTAINING FIFTY-FIVE (55) ACRES and FORTY-FIVE (45) SQUARE PERCHES of land, more or less, on which is erected a single two-story frame dwelling house, bank barn and other necessary outbuildings.

EXCEPTING AND RESERVING THEREFROM THE FOLLOWING THREE(3)
PARCELS OF LAND:

1. Parcel containing One (1) Acre of land conveyed by John F. Zeiders and Evelyn M. Zeiders, husband and wife to Ronald F. Mace, single man, dated February 17, 1979, recorded February 20, 1979 in Northumberland County Deed Book 560 Page 177.
2. Parcel containing One and Eighteen Thousandths (1.018) Acres of land conveyed by John F. Zeiders and Evelyn M. Zeiders husband and wife to Alvin C. Zeiders, dated February 17, 1979, recorded February 20, 1979, in Northumberland County Deed Book 560 Page 180.
3. Parcel containing One and Two Hundred Ninety Thousandths (1.290) Acres of land conveyed by John F. Zeiders and Evelyn M. Zeiders, husband and wife to Alvin C. Zeiders and Angie K. Zeiders, husband and wife, dated November 18, 1992, recorded December 2, 1992 in Northumberland County Record Book 885 Page 130.

BENJAMIN the same premises (with the above exceptions) which CLINTON HARVE WITMER and ADA WITMER, husband and wife, by their Deed dated September 24, 1970, and recorded September 30, 1970 in the Office for the Recording of Deeds in and for Northumberland County, Pennsylvania in Deed Book 891 at page 492, granted and conveyed unto John F. Zeiders and Evelyn M. Zeiders, husband and wife.

THIS IS A CONVEYANCE FROM MOTHER AND STEPFATHER TO SON AND WIFE, AND IS THEREFORE, EXEMPT FROM REALTY TRANSFER TAX.

TOGETHER with all and singular the tenements, hereditaments and appurtenances to the same belonging, or in anywise appertaining, and the reversion and reversions, remainder and remainders, rents, issues and profits thereof, and also all the estate, right, title, interest, property, claim and demand whatsoever, both in law and equity, of the said parties of the first part, of, in, to or out of the said premises, and every part and parcel thereof.

TO HAVE AND TO HOLD the said premises, with all and singular the appurtenances unto the said parties of the second part, their heirs and assigns, to and for the only proper use and behoof of the said parties of the second part, their heirs and assigns forever, as tenants by the entireties and the said John F. Zeiders and Evelyn M. Zeiders, husband and wife, Parties of the First Part, for themselves, their heirs, executors and administrators, do by these presents, covenant, grant and agree to and with the said parties of the second part, their heirs and assigns, that they, the said John F. Zeiders and Evelyn M. Zeiders, husband and wife, Parties of the First Part, for themselves, their heirs, all and singular the hereditaments and premises herein above described and granted, or mentioned and intended so to be, with the appurtenances unto the said parties of the second part, their heirs and assigns, against the said parties of the first part and their heirs, and against all and every other person or persons, whomsoever lawfully claiming or to

claim the same or any part thereof, shall and will, by these presents warrant and forever defend.

IN WITNESS WHEREOF, the said parties of the first part have hereunto set their hands and seals, the day and year first above written.

Attachment 6

**RIGHT-OF-WAY TO BE CONDEMNED
OVER PROPERTY OF
RONALD F. MACE AND DIANNE L. MACE**

Beginning at a point, said point being located at the intersection of the proposed centerline of electric line in the Centerline of State Route 3017 (SR 3017) being the Westerly division line of lands of Ronald F. Mace and Dianne L. Mace (DB 1019, PG. 618).

Thence along said centerline of SR 3017, North thirty-eight degrees fifty-three minutes thirty-nine seconds East (N 38°53'39" E) sixty-four and twenty-three one hundredths feet (64.23') more or less to a point.

Thence through lands of Ronald F. Mace and Dianne L. Mace, running parallel to and at a distance of fifty feet (50') perpendicular from the centerline of proposed electric line the following two (2) courses and distances **1.** South eighty-nine degrees fifty-nine minutes twenty-four seconds East (S 89°59'24" E) seven hundred thirteen and eighty-eight one hundredths feet (713.88') more or less to a point; **2.** North eighty-seven degrees fifty-nine minutes thirty-eight seconds East (N 87°59'38" E) eight hundred eighty-two and thirteen one hundredths feet (882.13') more or less to a point in the Easterly division line of lands of Ronald F. Mace and Dianne L. Mace and lands now or formerly of John F. and Evelyn M. Zeiders (DB 465 Pg. 407).

Thence along said dividing line crossing the proposed centerline of electric line at a distance of fifty-six and eight one-hundredths feet (56.08') more or less South twenty-eight degrees fifty-six minutes twenty-two seconds East (S 28°56'22" E) one hundred twelve and seventeen one hundredths feet (112.17') more or less to a point.

Thence through lands of Ronald F. Mace and Dianne L. Mace, running parallel to and at a distance of fifty feet (50') perpendicular from the centerline of proposed electric line the following two (2) courses and distances **1.** South eighty-seven degrees fifty-nine minutes thirty-eight seconds West (S 87°59'38" W) nine hundred thirty-four and seventy one hundredths feet (934.70') more or less to a point; **2.** North eighty-nine degrees fifty-nine minutes twenty-four seconds West (N 89°59'24" W) seven hundred ninety-six and twenty-nine one hundredths feet (796.29') (796.29') more or less to a point in the Centerline of State Route 3017.

Thence along said Centerline, North thirty-eight degrees fifty-three minutes thirty-nine seconds East (N 38°53'39" E) sixty-four and twenty-three one hundredths feet (64.23') more or less to a point. **The Point of Beginning.**

Said Easement containing three and eighty-two one-hundredths Acres (3.82+/- Acs.) more or less as shown on PPL drawing No. B389457 prepared by PPL Electric Utilities entitled "PLAN SHOWING ELECTRIC LINE RIGHT-OF-WAY TO BE CONDEMNED OVER PROPERTY OF RONALD F. MACE AND DIANNE L. MACE".

Bearings and distances described are based upon the centerline of the proposed electric line as surveyed by PPL Electric Utilities.

Attachment

7

METES AND BOUNDS:

| | | |
|---|---------------|---------|
| 1 | N 38°53'39" E | 64.23' |
| 2 | S 89°59'24" E | 713.88' |
| 3 | N 87°59'38" E | 882.13' |
| 4 | S 28°56'22" E | 112.17' |
| 5 | S 87°59'38" W | 934.70' |
| 6 | N 89°59'24" W | 796.29' |
| 7 | N 38°53'39" E | 64.23' |

TOTAL ROW AREA = 3.82 ACS. ±

LEGEND:
 IRON PIPE ●
 REBAR ●

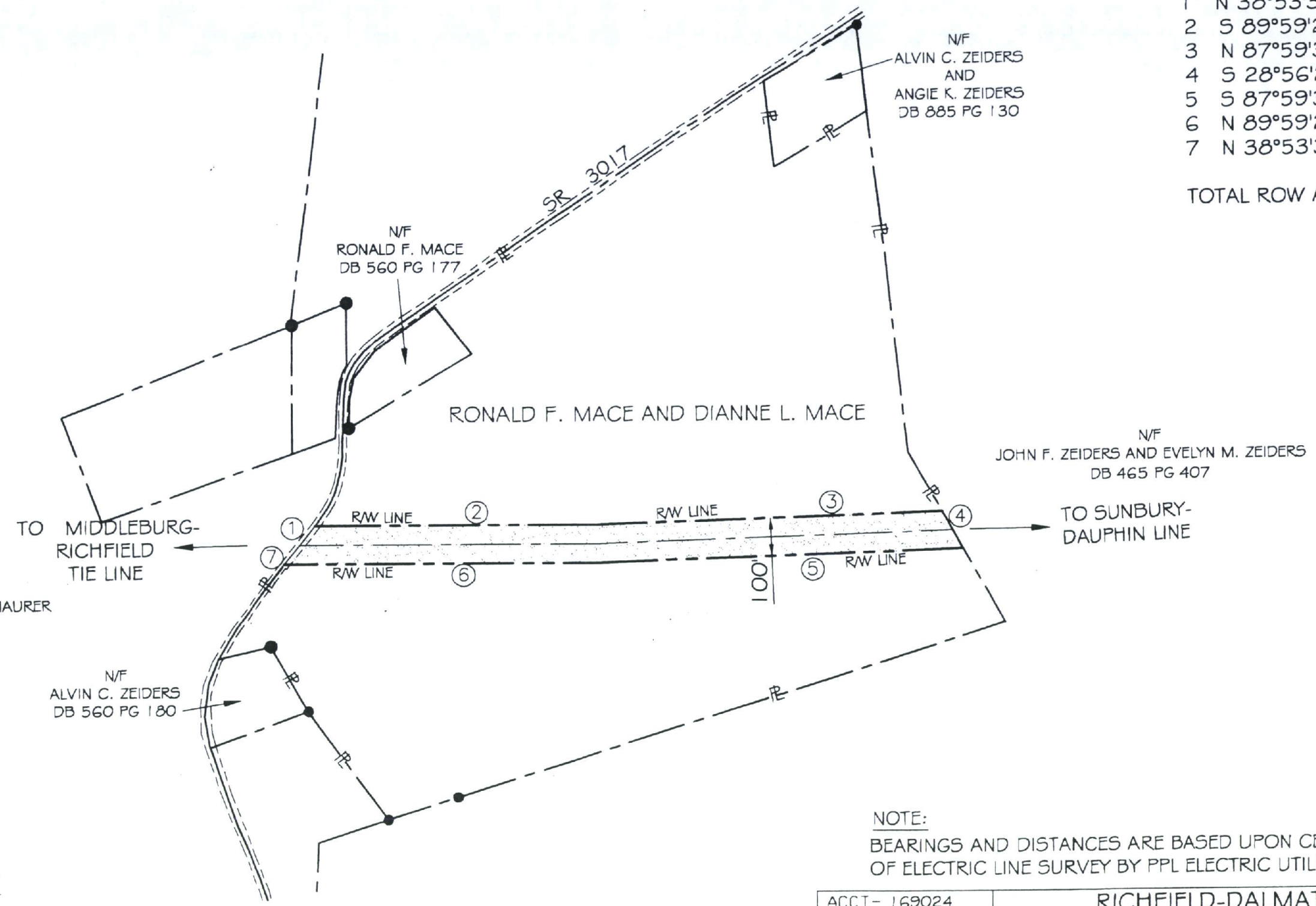

NOTE:
 BEARINGS AND DISTANCES ARE BASED UPON CENTERLINE OF ELECTRIC LINE SURVEY BY PPL ELECTRIC UTILITIES.



Agreement Dated _____
 Copy of this Plan _____
 Received By _____
 Date _____

51

NOTE: FOR EXACT LOCATION OF RW AND/OR FACILITIES WITHIN THE RW CONTACT THE LOCAL PPL ELECTRIC UTILITIES CORPORATION OFFICE.

| | | |
|--------------------------------|---|-------------------------|
| ACCT- 169024 | RICHFIELD-DALMATIA TIE LINE | |
| SCALE- NONE | PLAN SHOWING ELECTRIC LINE RIGHT OF WAY TO BE CONDEMNED | |
| BY- RRC | OVER PROPERTY OF RONALD F. MACE AND DIANNE L. MACE | |
| REVIEWED <i>MRS 04/01/2011</i> | DEED BOOK 1019, PAGE 618 | |
| | LOWER MAHANOH TOWNSHIP | NORTHUMBERLAND CO., PA. |
| CEU Confidential | APPROVED <i>Brian K. Patton</i> 9/11/2011 | PPL ELECTRIC UTILITIES |
| AC | PPL DRAWING NO. B389457 | SHEET NO. 1 |
| | | REV. 0 |

| NO. | DATE | ACCT. | REVISION | BY | REVIEWED | APPROVED | CAD ID |
|-----|------|-------|----------|----|------------|----------|--------|
| | | 41981 | | | | | C |
| | | | | | 231-169-N1 | | |

Attachment 8

I, DIANE M. KOCH, a duly elected and acting Assistant Secretary of PPL Electric Utilities Corporation, do hereby CERTIFY that the following is a true and correct copy of certain resolutions duly adopted by the Board of Directors of the Company by a Unanimous Written Consent, dated August 2, 2011, and that said resolutions have not been altered, amended or repealed and are in full force and effect.

WHEREAS, Michael W. Wendt and Logan W. Wendt are the owners of certain property in Perry Township, Snyder County, as more particularly described in Exhibit A; and

WHEREAS, Marvin Roger Hess and Leona H. Hess are the owners of certain property in Susquehanna Township, Juniata County, as more particularly described in Exhibit B; and

WHEREAS, Randall W. Clark is the owner of certain property in Lower Mahanoy Township, Northumberland County, as more particularly described in Exhibit C; and

WHEREAS, Elijah H. Lahr and Faye A. Lahr are the owners of certain property in Lower Mahanoy Township, Northumberland County, as more particularly described in Exhibit D; and

WHEREAS, Gary L. Lahr and Dorene C. Lahr are the owners of certain property in Lower Mahanoy Township, Northumberland County, as more particularly described in Exhibit E; and

WHEREAS, Roy L. Maurer and Cindy L. Maurer are the owners of certain property in Lower Mahanoy Township, Northumberland County, as more particularly described in Exhibit F; and

WHEREAS, Ronald F. Mace and Dianne L. Mace are the owners of certain property in Lower Mahanoy Township, Northumberland County, as more particularly described in Exhibit G; and

WHEREAS, John F. Zeiders and Evelyn M. Zeiders are the owners of certain property in Lower Mahanoy

Township, Northumberland County, as more particularly described in Exhibit H; and

WHEREAS, the Shoop Family Trust is the owner of certain property in Lower Mahanoy Township, Northumberland County, as more particularly described in Exhibit I; and

WHEREAS, Michael L. Schwalm is the owner of certain property in Lower Mahanoy Township, Northumberland County, as more particularly described in Exhibit J; and

WHEREAS, the construction by the Company of the Richfield-Dalmatia 69 kV Transmission Tie Line and Meiserville 69-12 kV Substation on, over, across or under the lands described in Exhibits A through J (the "Lands"), is necessary for the supply of light, heat and power to the public; and

WHEREAS, the Company has endeavored to agree but has not reached agreement with the landowners or their representatives upon the proper compensation, terms and conditions for the damage which will be done or is likely to be done to or sustained by them; and

WHEREAS, the Company is authorized by law to condemn and appropriate the properties necessary for such purposes; and

WHEREAS, Board of Directors approval is a necessary legal condition for the Company to appropriate the required rights-of-way for the Lands.

NOW THEREFORE, BE IT RESOLVED, That it is necessary to condemn and appropriate rights-of-way and easements on, over, across or under the Lands to the extent required for rights-of-way to be presently used for the overhead or underground construction, operation and maintenance of the Richfield-Dalmatia 69 kV Transmission Tie Line and Meiserville 69-12 kV Substation, for the transmission and/or distribution of electric light, heat and power, or any of them, including such poles, wires, conduits, cables, manholes, and all other facilities, fixtures and apparatus as may be necessary for the proper and efficient construction, operation and maintenance of such line, as well as to condemn in fee simple such property as necessary for the construction of a substation; and further

RESOLVED, That the Company shall and hereby does condemn and appropriate rights-of-way and easements ("Easement Area") to the extent necessary for the rights-of-way described above on, over, across or under the Lands owned or reputed to be owned by the above-named property owners, such rights-of-way being more fully described in Exhibit A, B, C, D, E, F, G, H, I or J, as applicable, and being necessary for the Company's corporate uses for the construction, operation, renewal, replacement, relocation, addition to, and maintenance of the facilities constituting the overhead or underground transmission line, including poles, wires, conduits, cables, manholes and all other necessary appurtenances for the transmission or distribution of electricity ("Electric Facilities"), on, over, across or under the rights-of-way described in Exhibit A, B, C, D, E, F, G, H, I or J, as applicable, together with: (1) the right of ingress and egress to, from, upon, and over the subject properties to access the Easement Area and Electric Facilities at all times for the construction, operation, maintenance, replacement, and reconstruction of the Electric Facilities and for any of the purpose aforesaid; (2) the right to cut down, trim, remove, and to keep cut down and trimmed by mechanical means or otherwise, any and all trees, brush, or other undergrowth now or hereafter growing on or within the Easement Area, as well as the right to cut down, trim, and remove any and all trees adjoining or outside of the Easement Area which in the judgment of PPL Electric, its successors, assigns, and lessees may at any time interfere with the construction, reconstruction, maintenance, or operation of the Electric Facilities or menace the same, and in connection with the aforementioned rights, the right to remove, if necessary, the root systems of said trees, brush, or other undergrowth; and (3) a prohibition against any buildings, swimming pools, or other improvements or structures whatsoever being built, constructed, or placed within the Easement Area, as well as any inflammable or explosive materials being stored within the Easement Area, as well as the right to remove any buildings, structures, or other improvements from the Easement Area; and further

RESOLVED, That the Company shall and hereby does condemn and appropriate fee simple title to the property more fully described in Exhibit B for the construction of a substation; and further

RESOLVED, That the proper officers of the Company are hereby authorized and directed to execute such bonds and/or other paper, to take such action and to bring such proceedings on behalf of the Company as may be necessary or advisable in the exercise of the power of eminent domain to condemn and appropriate such rights-of-way and easements or fee simple title and to enter upon, use and occupy any of the Lands for the purposes described in the above resolutions.

IN WITNESS WHEREOF, I have hereunto set my hand and affixed the seal of the Company this 10th day of August, 2011.

Assistant Secretary

g:\steno\subs\ppl electric utilities\080211 richfield dalmatia cert.doc

Attachment 9



**MAGNETIC
FIELD
MANAGEMENT**
**PPL Electric Utilities
Corporation**

DECEMBER 2004

TABLE OF CONTENTS

| | |
|---|----|
| INTRODUCTION | 1 |
| DEVELOPMENT OF PPL EU's MAGNETIC FIELD MANAGEMENT PROGRAM..... | 6 |
| VARIABLES THAT AFFECT MAGNETIC FIELDS | 6 |
| Effect of Phase Current on Magnetic Fields | 6 |
| Effect of Conductor Configuration on Magnetic Fields | 7 |
| Effect of Distance from the Magnetic Field Source | 7 |
| SUMMARY OF PPL EU's MAGNETIC FIELD MANAGEMENT PROGRAM..... | 8 |
| MAGNETIC FIELD MANAGEMENT PROGRAM GUIDELINES | 9 |
| Overhead Lines | 9 |
| New or Rebuilt Transmission Lines | 9 |
| Reconductoring or Adding Additional Circuits to Existing Transmission Lines | 14 |
| Distribution Lines | 14 |
| Underground Transmission Lines..... | 15 |
| CHARTS..... | 16 |

INTRODUCTION

At PPL Electric Utilities Corp. (PPL EU), magnetic field management means investigating and implementing methods at low or no cost to reduce magnetic fields in new or rebuilt transmission and distribution lines. This document explains PPL EU's Magnetic Field Management Program, which is part of PPL EU's larger Electric and Magnetic Fields (EMF) policy.

PPL EU's View

Some people are worried that electric and magnetic fields are harming their health. Others think the scientific research does not show a problem at all, and still others believe there's just too much scientific uncertainty to draw any conclusions.

Here's what we do know now. Various panels of scientists that have reviewed the EMF research generally have drawn two main conclusions. First, the large body of evidence does not demonstrate that EMF are harmful. Second, additional research is recommended to explore questions raised in some studies.

Given these conclusions, PPL EU is taking a reasoned approach in responding to the EMF issue. PPL EU's approach to the EMF issue consists of five elements:

- Providing EMF information to customers and employees
- Providing magnetic field measurements
- Establishing and implementing a magnetic field management program to reduce magnetic fields in new or rebuilt facilities when it can be done at no, or low, cost
- Integrating EMF in the public involvement process that PPL EU undertakes in the siting of transmission lines
- Have supported additional research

EMF Are All Around Us

Electric and magnetic fields occur in nature and in all living things. The earth, for instance, has a magnetic field, which makes the needle on a compass point north.

Electric fields and magnetic fields of a different type also surround every wire that carries electricity. In everyday life, these EMF arise from several basic sources, including power lines, electrical appliances, home and building wiring, other utility lines and cables, and currents flowing on water pipes. Though they often occur together, EMF are made up of two separate components:

Electric Fields

Electric fields are produced by the voltage—or electrical pressure—on a wire. The higher the voltage, the higher the electric field. As long as a wire is energized—has voltage present—an electric field is present (see Figure 1). In other words, an appliance, or an electric power line, doesn't actually have to be turned on to create an electric field. It just has to be plugged in. Electric fields diminish with distance and can be blocked or partially shielded by objects such as trees and houses.

Magnetic Fields

Magnetic fields are created by the current or flow of electricity through a wire. Generally speaking, the higher the current, the higher the magnetic field. Because they only occur when current is flowing, magnetic fields are present only when the power is turned on (see Figure 1). Magnetic fields also diminish with distance, but—unlike electric fields—are not blocked by common objects. In recent years, public and scientific interest has turned toward the magnetic field component of EMF because of some scientific studies regarding these fields.

Figure 1

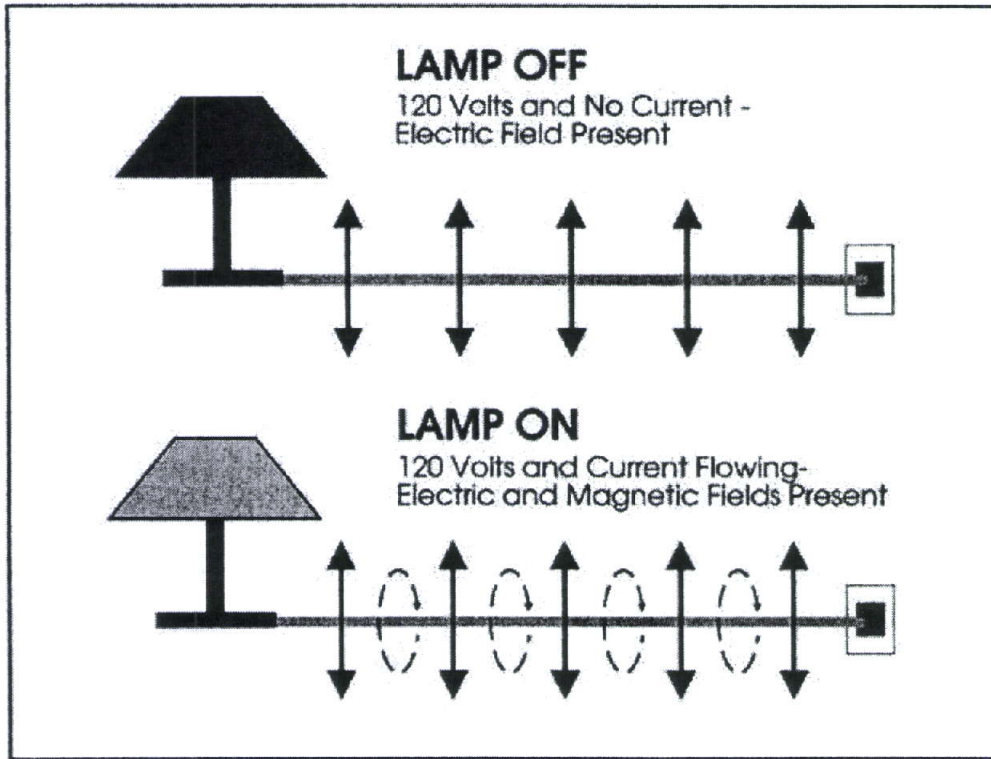

Figure 2









| Magnetic field strengths decrease with distance Magnetic fields are measured in milligauss | | Source: "EMF in Your Environment", U.S. Environmental Protection Agency 1992 | | |
|---|---|--|-----------|-----------|
| | | At 6 inches | At 1 foot | At 2 feet |
| Clothes dryer |  | 2 to 10 | * to 3 | * |
| Microwave oven |  | 100 to 300 | 1 to 200 | 1 to 30 |
| Toaster |  | 5 to 20 | * to 7 | * |
| Power drill |  | 100 to 200 | 20 to 40 | 3 to 6 |
| Can opener |  | 500 to 1500 | 40 to 300 | 3 to 30 |
| Mixer |  | 30 to 600 | 5 to 100 | * to 10 |
| Hair dryer |  | 1 to 700 | * to 70 | * to 10 |
| Color television |  | Data not available | * to 20 | * to 8 |

FIGURE 2 * The magnetic field measurement at this distance from the operating appliance could not be distinguished from background measurements taken before the appliance had been turned on.

Measuring Magnetic Fields

Magnetic fields usually are measured in a unit called a milligauss. Magnetic field levels found in the living areas of homes typically range from less than 1 milligauss to about 4 milligauss according to the U.S. Environmental Protection Agency. They can be higher in some cases. The levels next to appliances can exceed 1,000 milligauss (1 gauss). Figures 2 and 3 show how the strength of the field falls off as you move away from the source, just as the heat of a campfire grows weaker as you walk away from it. For overhead power lines, the strength of the magnetic fields is dependent upon a number of factors that will be explained later. Those factors produce a magnetic field that drops off rapidly as you move away from the power line.

Figure 3

| Sample Magnetic Field Levels in Milligauss | | | | |
|---|-------------------------------|---------------|----------------|----------------|
| Type of Overhead Power Line | Distance from the line | | | |
| | Under the line | 50 ft. | 100 ft. | 200 ft. |
| 220 kV and 500 kV | 5-400 | 5-250 | 1-75 | 0.5-20 |
| 69 kV and 138 kV | 3-80 | 0.5-2.5 | 0.1-10 | 0.1-3 |
| 12 kV and below | 0.4-20 | 0.1-1 | - | - |

The magnetic field values provided in this table represent a general range of values associated with the types of overhead power lines listed and are provided for illustration. There will be circumstances in which there will be magnetic field levels above or below the range of values provided due to variations in such factors as height of the wires, current flow and so on.

DEVELOPMENT OF PPL EU's MAGNETIC FIELD MANAGEMENT PROGRAM

One element of our response to EMF concerns expressed by some of our customers is PPL EU's Magnetic Field Management Program. The program was initiated in March 1991 because PPL EU believes it makes good sense, as a matter of policy, to respond to the concerns expressed by some of our customers and to reduce magnetic fields in new and rebuilt facilities where it can be done with either no-cost or low-cost design changes.

This document updates the original program which has been revised several times since 1991. These guidelines were developed by PPL EU's EMF Working Group.

VARIABLES THAT AFFECT MAGNETIC FIELDS

Magnetic fields from transmission and distribution lines are a function of a number of design variables. The following parameters affect the magnetic field levels produced by transmission and distribution lines:

- Current
- Height of conductors above ground
- Configuration of conductors
- Distance from the line

EFFECT OF PHASE CURRENT ON MAGNETIC FIELDS

At power frequencies (i.e., 60 hertz), the magnetic field level is a function of the current or flow of electricity through a wire. Keeping all other parameters the same, the magnetic field is proportional to the current. Hence, if the current increases by 25 percent, the resulting magnetic field level will increase by 25 percent.

The overall load current on any line varies with the demand for power. It's usually highest during daytime hours and lowest at night. There also are weekly, monthly, seasonal and yearly variations.

The difference in the currents between each phase in a multiphase line also can affect the magnetic field. This difference is called phase unbalance. For a constant load, a statistical analysis of this phase unbalance can be made to determine its effect on the magnetic field. Close to the line, there is very little effect. However, the phase unbalance slows the rate at which the magnetic field decreases with distance from the line.

EFFECT OF CONDUCTOR CONFIGURATION ON MAGNETIC FIELDS

In the transmission and distribution of power, utilities like PPL EU presently use both three-phase and single-phase lines. Each phase on a three-phase power line has either a single conductor or a bundle of two or more conductors. In a three-phase system, the ground-level magnetic field is a result of the fields produced by the currents in each of the phases. Placing the three phases as close together as possible (compaction) creates some field cancellation, and the ground-level magnetic field is reduced. However, appropriate phase separation is required for the reliable operation of the line. In addition, the arrangement of the phases can create some; field cancellation and reduction of the ground-level magnetic field.

EFFECT OF DISTANCE FROM THE MAGNETIC FIELD SOURCE

Magnetic field strength diminishes with the vertical and lateral distances from the magnetic field source. Increasing the height of the conductors above ground is useful for magnetic field reduction at ground level, but may result in increased structure costs and increased aesthetic impact of the structures. Another possible method of increasing the distance to the magnetic field source is to increase the right-of-way requirements. By keeping buildings off increased rights of way, thereby requiring the public to live and work further away from lines, exposure to magnetic fields produced by the lines can be reduced. Increases in right of way are not always practical and may increase costs significantly, however.

SUMMARY OF PPL EU's MAGNETIC FIELD MANAGEMENT PROGRAM

Under its Magnetic Field Management Program, PPL EU has changed the way it builds and rebuilds some of its transmission and distribution lines. These design changes reduce magnetic field levels (assuming balanced circuit loadings and phase currents) by up to 69 percent in most of the company's new transmission lines. These guidelines now are being applied to new and reconstructed transmission facilities, based on this program.

The distribution component of the program focuses on 12 kV lines, the company's standard distribution voltage. It concentrates on the three-phase, primary 12 kV lines, since these are the most heavily loaded facilities and often are located in densely populated areas. The guidelines in this program are being applied to these three-phase, primary 12 kV lines.

A maximum 3-5 percent change in estimated cost was used as the limit for the guidelines since this value is consistent with low cost, is within estimating accuracy and is likely to have little impact on overall line costs.

The magnetic field calculations used in this document for the design of PPL EU's overall magnetic field management plan assume balanced load conditions among the phases and a fixed level of current, not necessarily representative of specific transmission or distribution lines. These levels were calculated using the Electric Power Research Institute's ENVIRO computer program. Under actual operating conditions, the magnetic field levels that result may vary due to such things as actual load per circuit, overall current on each phase conductor and the electrical configuration and operation of each line.

MAGNETIC FIELD MANAGEMENT PROGRAM GUIDELINES

The guidelines for magnetic field management are noted below, with discussion points for each.

OVERHEAD LINES

NEW OR REBUILT TRANSMISSION LINES

- 1. Balance transmission circuit loads and phase currents as much as possible.**
 - PPL EU should continue to make every effort to balance loadings between the two circuits of a double circuit line when planning new or rebuilt facilities to maximize the effects of reverse phasing.
 - PPL EU should continue the practice of balancing single-phase loads across the three phases of the distribution system. (Unbalanced phase currents on the distribution system are reflected through to the transmission system.)
 - Unbalanced phase currents result in higher magnetic fields that do not drop off as quickly with distance as do the fields resulting from balanced phase currents.
 - For a 5 percent phase current unbalance, the magnetic field 50 feet from the centerline of a single circuit 138 kV line could be more than twice the value than if the same line had balanced phase circuits.
 - Balanced phase currents on each three-phase distribution circuit also reduce magnetic fields from the distribution circuits themselves. In addition, they reduce magnetic fields on the transmission system from which the distribution system circuits are supplied and connected through substations.
 - Apart from magnetic field considerations, balanced phase currents on each three-phase distribution circuit also reduce line losses and improve the system voltage.

2. Continue with the present practice of using long-span construction as the PPL EU 138/69 kV standard

- Structure designs for short-span and long-span construction are illustrated on Charts I and II, respectively.
 - Short-span design does not significantly reduce magnetic fields when compared to long-span design even though it is more compact than long-span design. Comparison of the magnetic field values from Chart III indicates essentially the same values. Therefore, short-span design should not be used solely to reduce magnetic fields.
 - PPL EU will continue to use long-span construction for 138/69 kV double-circuit lines and for single-circuit/future-double-circuit lines.
 - For single-circuit/future-double-circuit lines, PPL EU will continue to install two conductors on the top positions and one in the middle position as shown in Chart IV.
 - This arrangement minimizes magnetic fields as shown in Chart V by placing the three initial conductors higher on the structure, which increases the ground clearances, and by placing the conductors in a triangular configuration.

3. Compact design structures are not a low-cost alternative and should be used for magnetic field reduction only in special applications.

Chart VI illustrates the compact design structure.

- The compact design increases the initial installation costs by 79 percent when compared to the long-span design but reduces the magnetic field from 9 mG to 3 mG (about 67 percent) at the edge of the 100-foot-wide right of way as shown on Chart III.

4. Reverse phase new or rebuilt double-circuit transmission lines for all voltage levels.

- Reverse phasing was adopted by PPL EU in March 1991 for double-circuit 138/69 kV transmission lines and in April 1992 for all other double circuit transmission lines. Reverse phasing is shown in Chart VII. Reverse phasing will reduce the magnetic fields when the current flow on both circuits is in the same

direction. Calculated values contained here are based on balanced and equal phase currents on both circuits.

- Reverse phasing reduces the magnetic field of a double circuit 138 kV single pole transmission line from 29 mG to 9 mG (about 69 percent) at the edge of the 100-foot-wide right of way as shown on Chart III.
- Reverse phasing reduces the magnetic field of a double circuit 230 kV single pole transmission line from 49 mG to 16 mG (about 67 percent) at the edge of the 150-foot-wide right of way as shown on Chart VIII.
- Reverse phasing reduces the magnetic field of a double-circuit 500 kV single pole transmission line from 37 mG to 21 mG (about 43 percent) at the edge of the 200-foot-wide right of way as shown on Chart IX.
- When new or rebuilt double-circuit lines require tapping existing double-circuit lines, PPL EU will review the existing lines to determine if reverse phasing can be provided at low cost.
- Computer modeling is required to develop the optimum phasing and overall conductor arrangements for lines added to, or rebuilt in, multiple-line corridors.
 - Merely adding a reverse-phase double-circuit line to an existing transmission line corridor or reverse phasing a rebuilt line in the multiple-line corridor will not necessarily produce lower magnetic field levels at the edge of the corridor right of way.
 - The corridor must be computer modeled with all the lines, existing phase conductor locations and currents. Then, magnetic field calculations must be made varying the phase arrangements of the new or reconstructed line to determine the appropriate phasing arrangement.
 - Current flow direction on a line also must be considered. For example, a reverse-phased line should have the current flowing in the same direction on both circuits. If the current flow is in the opposite direction for one circuit, reverse phasing will not produce the lowest magnetic field and another phase arrangement that produces lower fields may need to be utilized.

5. Increase the minimum ground clearance for all new transmission lines.

138/69 kV Transmission Lines

- Increasing the minimum line design ground clearance from 25 feet to 30 feet may add up to about 5 percent to the installed cost of a new double-circuit single pole 138/69 kV line. For a given project, such cost may be substantially less, however. In fact, PPL EU frequently uses higher-than-minimum ground clearances due to such features as road crossings, line crossings and site-specific terrain. With long-span reverse-phase design, the magnetic field is reduced from 9 mG to 7 mG (about 22 percent) at the edge of a 100-foot-wide right of way as shown in Chart X.
 - In the actual design of transmission lines to include higher minimum ground clearances, there may be limited segments (such as highway crossings, severe slopes and transmission line crossing locations) where National Electrical Safety Code (NESC) minimum ground clearances may need to be used. The NESC minimum ground clearances are less than the increased ground clearance discussed previously.

230 kV Transmission Lines

- Increasing the minimum line design ground clearances from 27 feet to 32 feet may add up to about 5 percent to the cost of a single-circuit single-pole line (current standard). For a given project, such cost may be substantially less, however. In fact, PPL EU frequently uses higher-than-minimum ground clearances due to such features as road crossings, line crossings and site-specific terrain. By increasing the clearances, the magnetic field is reduced from 30 mG to 28 mG (about 7 percent) at the edge of a 150-foot-wide right of way.
- Increasing clearances from 27 feet to 32 feet could theoretically add up to about 2.8 percent to the cost of a double-circuit single-pole line (current standard) and reduce the magnetic field of a reverse-phase line from 16 mG to 15 mG (about 6 percent) at the edge of a 150-foot-wide right of way. Chart XI is a summary of this data.
- Studies are required for each new 230 kV line to determine optimum structure types, ground clearances, configurations and designs to reduce field levels. Such

studies could include analysis of reduction measures such as additional minimum ground clearances, increasing conductor tensions, using reduced phase spacing (a "Delta" configuration on a single-circuit line), installing the second circuit initially, and/or adding a second set of conductors that are reverse phased and operated in parallel with the first set (bundled/split phase).

500 kV Transmission Lines

- Increasing ground clearances from 33 feet to 53 feet may add up to about 4.5 percent to the cost of a single-circuit "H-frame" line (current standard). For a given project, such cost may be substantially less, however. In fact, PPL EU frequently uses higher-than-minimum ground clearances due to such features as road crossings, line crossings and site-specific terrain. By increasing the clearances, the magnetic field is reduced from 42 mG to 35 mG (about 17 percent) at the edge of a 200-foot-wide right of way.
- Increasing ground clearances from 33 feet to 53 feet could theoretically add up to 2.8 percent to the cost of a double-circuit "H-frame" line (current standard) and reduces the magnetic field of a reverse-phase line from 21 mG to 16 mG (about 24 percent) at the edge of a 200-foot-wide right of way. Chart XII is a summary of this data.
- Studies are required for each new 500 kV line to determine optimum structure types, ground clearances, configurations and designs to reduce field levels. Such studies could include analysis of reduction measures such as additional minimum ground clearances, increasing conductor tensions, using reduced-phase spacing (a "Delta" configuration on a single circuit line), installing the second circuit initially, and/or adding a second set of conductors that are reverse phased and operated in parallel with the first set (bundled/split phase).

RECONDUCTORING OR ADDING ADDITIONAL CIRCUITS TO EXISTING TRANSMISSION LINES

When reconductoring or adding additional circuits to existing transmission lines, PPL EU will evaluate low-cost or no-cost options for magnetic field management on a case-by-case basis.

When reconductoring existing transmission lines or adding additional circuits, low-cost alternatives may not exist; however, the following steps will be taken:

- For a single-circuit line, the use of a Delta arrangement or other modifications on the existing structure, with reduced-phase spacing, will be evaluated.
- For double-circuit lines, application of reverse phasing may reduce the magnetic field under the line and within the right of way and will be evaluated.
- For single- and double-circuit lines, evaluate using higher conductor tensions that can increase the minimum line design ground clearance.

DISTRIBUTION LINES

At the 12 kV distribution level, new main three-phase lines will continue to be constructed with five feet of additional ground clearance.

- Main lines are the most heavily loaded sections of a distribution line and therefore have the highest magnetic fields associated with them.
- Increasing the ground clearance by five feet reduces the magnetic field under the line from 14 mG to 11 mG using the standard eight-foot crossarm design. These values are based on increasing pole heights from 45 feet to 50 feet and a typical operating current of 300 amps per phase.
- Chart XIII is a summary of this data. Increasing ground clearance by five feet could theoretically add about 5 percent to the cost of a typical distribution line.

UNDERGROUND TRANSMISSION LINES

Underground transmission lines are required due to environmental or land use factors or restrictions on available clearances, PPL EU will evaluate options for magnetic field management techniques on a case-by-case basis.

- The phase arrangement that produces the lowest field will be determined.
- The depth of burial of the line will be determined considering the cost of excavation and the location of other buried utilities in the area.
- The use of steel pipe ferromagnetic shielding that reduces magnetic fields will be evaluated.

Short-Span Construction

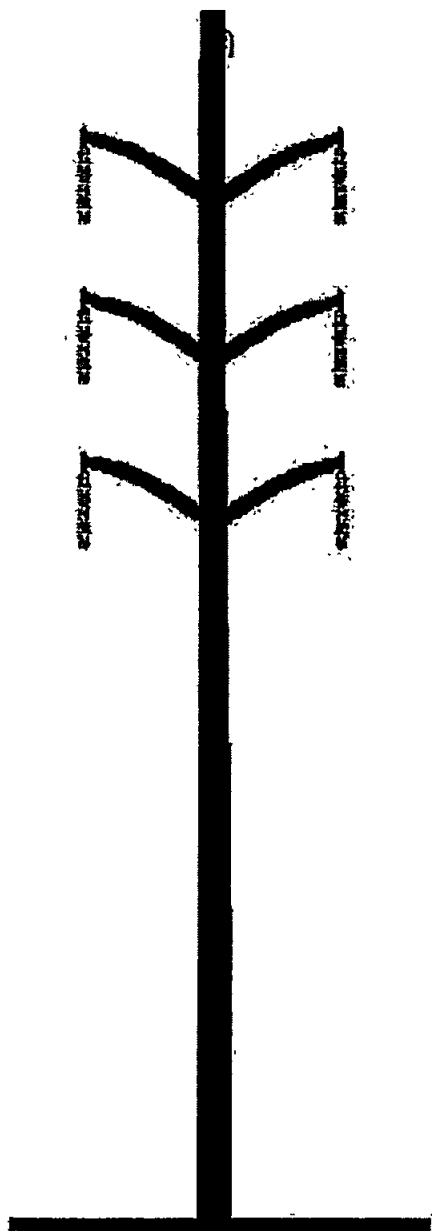

- **More compact design**
- **Should not be used solely to reduce magnetic fields**
- **Typical conductor data:**
 - 1 3/8" HS steel overhead ground wire - 7.3 feet sag
 - 6-556.5 KCMIL 24/7 ACSR power conductors - (PARAKEET) 10.0 feet sag
 - Average span - 400 feet

Long-Span Construction Remains PPL EU 138 kV Standard

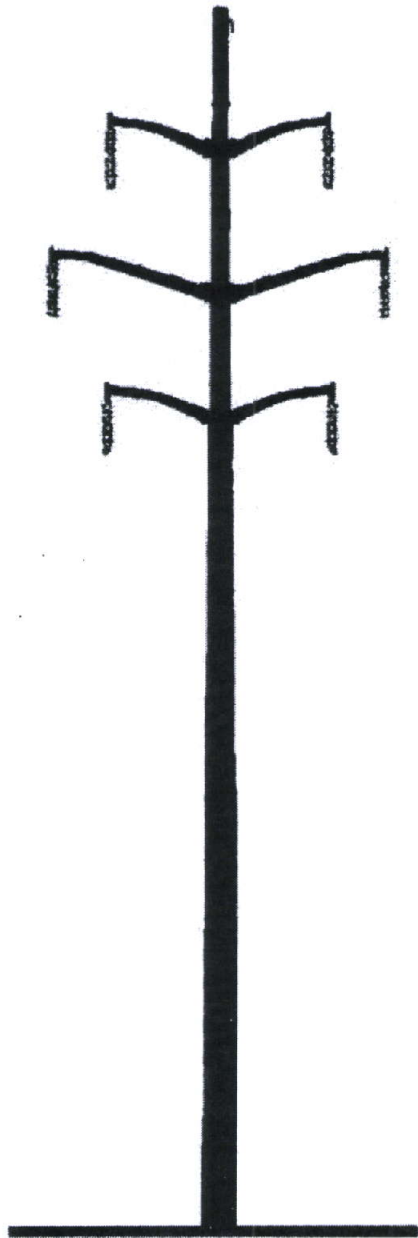

- Lower cost alternative
- Reduces magnetic fields due to higher structures
- Typical conductor data:
 - 1 3/8" HS steel overhead ground wire - 17.3 feet sag
 - 6-556.5 KCMIL 24/7 ACSR power conductors - (PARAKEET) 23.0 feet sag
 - Average span - 600 feet

**138/69 kV REVERSE-PHASE TRANSMISSION LINES
CALCULATED MAGNETIC FIELDS AT 400 AMPERES**

| TYPE CONSTRUCTION | MAGNETIC FIELD IN MILLIGAUSS AT THE EDGE OF THE RIGHT OF WAY |
|-------------------------------|---|
| SHORT SPAN (CHART I) | 30 |
| SHORT SPAN (REVERSE PHASE) | 8 |
| LONG SPAN (CHART II) | 29 |
| LONG SPAN (REVERSE PHASE) | 9 |
| COMPACT (CHART VI) | 14 |
| COMPACT (REVERSE PHASE) | 3 |

The edge of right of way is 50 feet from the line centerline.
 The 400 ampere phase current is balanced between phases.
 Calculations are based on a minimum ground clearance of 25 feet.
 LONG SPAN, SHORT SPAN and COMPACT are double-circuit lines.

Typical Single-Circuit Structure Designs



Top/Middle

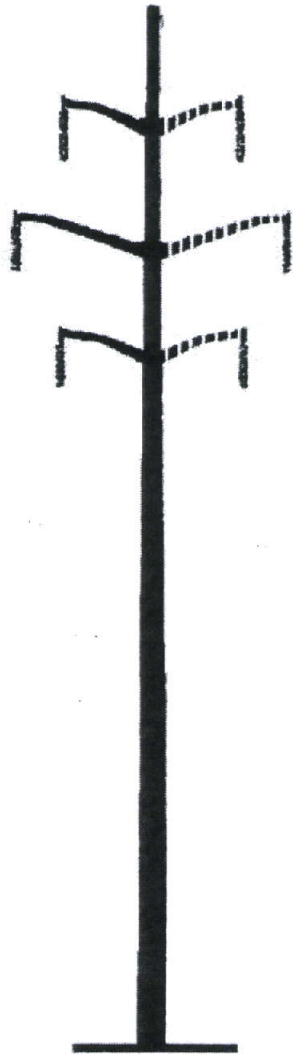

Vertical



Top/Middle/Bottom

——— initial single circuit
- - - - future second circuit

**138/69 kV SINGLE CIRCUIT TRANSMISSION LINES
CALCULATED MAGNETIC FIELDS AT 400 AMPERES**

| TYPE CONSTRUCTION | MAGNETIC FIELD IN MILLIGAUSS AT THE EDGE OF THE RIGHT OF WAY |
|----------------------|---|
| TOP/MIDDLE/BOTTOM | 20 |
| VERTICAL | 17 |
| TOP/MIDDLE | 12 |

The edge of right of way is 50 feet from the line centerline.
The 400 ampere phase current is balanced between phases.
Calculations are based on a minimum ground clearance of 25 feet.

Compact Design Structure



- Minimize magnetic fields due to compact design
- Not a low-cost alternative
- Typical conductor data:
 - 1 3/8" HS steel overhead ground wire - 9.0 feet sag
 - 6-556.5 KCMIL 24/7 ACSR power conductors - (PARAKEET) 9.0 feet sag
 - Average span - 300 feet

Reverse Phasing of Double-Circuit Transmission Lines

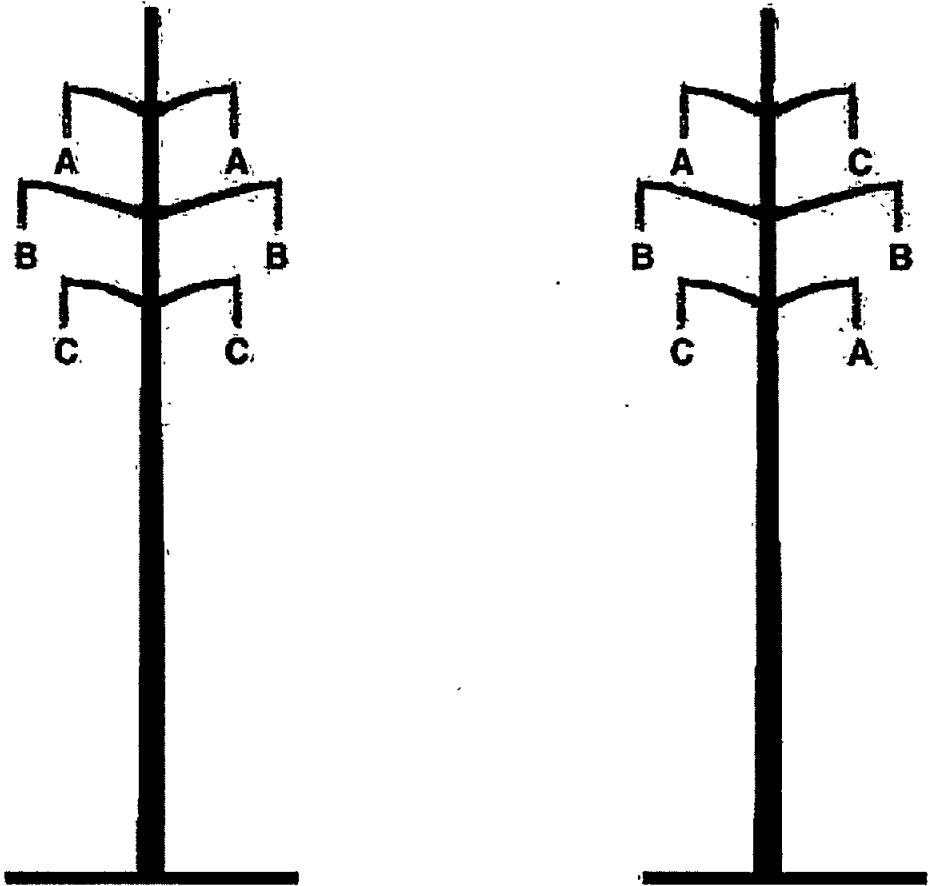

From: → → → → To:

Reverse phasing also can be one of the following phase arrangements:

| | | | | | | | | | | | | | |
|---|---|----|---|---|----|---|---|----|---|---|----|---|---|
| A | B | | B | A | | B | C | | C | A | | C | B |
| C | C | or | C | C | or | A | A | or | B | B | or | A | A |
| B | A | | A | B | | C | B | | A | C | | B | C |

**230 kV REVERSE-PHASE TRANSMISSION LINES
CALCULATED MAGNETIC FIELDS AT 800 AMPERES**

| TYPE CONSTRUCTION | MAGNETIC FIELD IN MILLIGAUSS AT THE EDGE OF THE RIGHT OF WAY |
|---|---|
| DOUBLE CIRCUIT POLE | 49 |
| DOUBLE CIRCUIT POLE (REVERSE-PHASE) | 16 |

The edge of right of way is 75 feet from the line centerline.
The 800 ampere phase current is balanced between phases.
Calculations are based on a minimum ground clearance of 27 feet.

**500 kV REVERSE-PHASE TRANSMISSION LINES
CALCULATED MAGNETIC FIELDS AT 1100 AMPERES**

| TYPE CONSTRUCTION | MAGNETIC FIELD IN MILLIGAUSS AT THE EDGE OF THE RIGHT OF WAY |
|---|---|
| DOUBLE CIRCUIT POLE | 37 |
| DOUBLE CIRCUIT POLE (REVERSE PHASE) | 21 |

The edge of right of way is 100 feet from the line centerline.
The 1,100 ampere phase current is balanced between phases.
Calculations are based on a minimum ground clearance of 33 feet.

**INCREASED 138/69 kV MINIMUM GROUND CLEARANCE
CALCULATED MAGNETIC FIELDS AT 400 AMPERES**

| TYPE CONSTRUCTION | MINIMUM GROUND CLEARANCE FEET | MAGNETIC FIELD IN MILLIGAUSS AT THE EDGE OF THE RIGHT OF WAY |
|------------------------------|--|---|
| SINGLE CIRCUIT TOP/MIDDLE | 25 | 12 |
| SINGLE CIRCUIT TOP/MIDDLE | 30 | 10 |
| LONG SPAN | 25 | 29 |
| LONG SPAN | 30 | 26 |
| LONG SPAN (REVERSE PHASE) | 25 | 9 |
| LONG SPAN (REVERSE PHASE) | 30 | 7 |

The edge of right of way is 50 feet from the line centerline.
The 400 ampere phase current is balanced between phases.

**INCREASED 230 kV MINIMUM GROUND CLEARANCE
CALCULATED MAGNETIC FIELDS AT 800 AMPERES**

| TYPE CONSTRUCTION | MINIMUM GROUND CLEARANCE FEET | MAGNETIC FIELD IN MILLIGAUSS AT THE EDGE OF THE RIGHT OF WAY |
|---|--|---|
| SINGLE CIRCUIT TOP/MIDDLE | 27 | 30 |
| SINGLE CIRCUIT TOP/MIDDLE | 32 | 28 |
| DOUBLE CIRCUIT POLE | 27 | 49 |
| DOUBLE CIRCUIT POLE | 32 | 46 |
| DOUBLE CIRCUIT POLE (REVERSE PHASE) | 27 | 16 |
| DOUBLE CIRCUIT POLE (REVERSE PHASE) | 32 | 15 |

The edge of right of way is 75 feet from the line centerline.
The 800 ampere phase current is balanced between phases.

**INCREASED 500 kV MINIMUM GROUND CLEARANCE
CALCULATED MAGNETIC FIELDS AT 1,100 AMPERES**

| TYPE CONSTRUCTION | MINIMUM GROUND CLEARANCE FEET | MAGNETIC FIELD IN MILLIGAUSS AT THE EDGE OF THE RIGHT OF WAY |
|---|--|---|
| SINGLE CIRCUIT "H" STRUCTURE | 33 | 42 |
| SINGLE CIRCUIT "H" STRUCTURE | 53 | 35 |
| DOUBLE CIRCUIT POLE | 33 | 37 |
| DOUBLE CIRCUIT POLE | 53 | 31 |
| DOUBLE CIRCUIT POLE (REVERSE PHASE) | 33 | 21 |
| DOUBLE CIRCUIT POLE (REVERSE PHASE) | 53 | 16 |

The edge of right of way is 100 feet from the line centerline.
The 1,100 ampere phase current is balanced between phases.

**12 kV DISTRIBUTION LINES
CALCULATED MAGNETIC FIELDS AT 300 AMPERES**

| TYPE CONSTRUCTION | POLE HEIGHT FEET | MAGNETIC FIELD IN MILLIGAUSS* | |
|----------------------|------------------------|-------------------------------|-------------------------------|
| | | AT CENTERLINE | AT 30 FEET FROM CENTERLINE |
| STANDARD CROSSARM | 45 | 14 | 7 |
| STANDARD CROSSARM | 50 | 11 | 6 |

* Field level under the line at mid-span based on 300 amps, balanced loading, one meter above ground level.

Attachment 10

PPL DESIGN CRITERIA AND SAFETY PRACTICES

The National Electrical Safety Code (NESC) is a set of rules to safeguard people during the installation, operation, and maintenance of electric power lines. The NESC contains the basic provisions considered necessary for the safety of employees and the public. Although it is not intended as a design specification, its provisions establish minimum design requirements. PPL Electric Utilities Corp. (PPL) has developed design specifications and safety rules which meet or surpass all requirements specified by the NESC.

Engineering Design Criteria and Parameters

The NESC includes loading requirements and clearances for the design, construction, and operation of power lines. The "loads" on conductors and supporting structures are the mechanical forces that develop from the weight of the conductors, the weight of ice on the conductors, plus wind pressure on the conductors and supporting structures. Loading requirements are the loads on the conductors and structures that are anticipated assuming certain ice and wind conditions. Loading requirements always contain "safety factors" to allow for unknown or unanticipated contingencies. The clearances and loading requirements contained in the NESC were developed to ensure public safety and welfare.

PPL transmission line design standards meet or surpass the NESC standards. For example, the relative order of grades of construction for conductors and supporting structures is B, C, and N; Grade B being the highest. According to the NESC standards, construction Grades B, C, or N may be used for transmission lines (except at crossings of railroad tracks and limited access highways where Grade B construction is specified). However, PPL designs all of its transmission lines for Grade B construction. The use of Grade B design and construction specifies enhancements such as larger-minimum crossarm dimensions, larger-minimum conductor size, and increased safety factors.

Another example is the design parameters utilized to account for ice and wind loadings on the overhead ground wire (OHGW) and power conductors. The NESC standard ice and wind design magnitudes for the PPL territory are 0.5 inch thickness of radial ice combined with four pounds per square foot horizontal wind pressure (equivalent to 40-mile per hour wind velocity). The conductor sags and tensions used in line designs are the result of various ice and wind combinations, depending on the elevation at the line location and line design voltage. The conductor sags and tensions used in the design of all PPL transmission lines are at least 0.5-inch ice combined with eight pounds wind pressure (equivalent to 57 miles per hour wind velocity). This means that PPL lines are designed to operate safely and reliably during inclement weather even more severe than assumed by the NESC. In addition, PPL transmission lines are designed with more clearance to the ground than required by the NESC. The tables below compare PPL and NESC ground clearances for lines of various voltages.

138 kV

| <u>Surface Underneath Conductors</u> | <u>Vertical Clearance to Ground</u> | |
|---|-------------------------------------|-------------------|
| | <u>NESC Standard</u> | <u>PPL Design</u> |
| Roads, streets, alleys | 21 Ft. | 30 Ft. |
| Other land traversed by vehicles (such as cultivated field, forest, etc.) | 21 Ft. | 30 Ft. |
| Spaces accessible to pedestrians only | 17 Ft. | 30 Ft. |
| Railroad tracks | 31 Ft. | 35 Ft. |

230 kV

| <u>Surface Underneath Conductors</u> | <u>Vertical Clearance to Ground</u> | |
|---|-------------------------------------|-------------------|
| | <u>NESC Standard</u> | <u>PPL Design</u> |
| Roads, streets, alleys | 23 Ft. | 32 Ft. |
| Other land traversed by vehicles (such as cultivated field, forest, etc.) | 23 Ft. | 32 Ft. |
| Spaces accessible to pedestrians only | 19 Ft. | 32 Ft. |
| Railroad tracks | 31 Ft. | 36 Ft. |

500 kV

| <u>Surface Underneath Conductors</u> | <u>Vertical Clearance to Ground</u> | |
|---|-------------------------------------|-------------------|
| | <u>NESC Standard</u> | <u>PPL Design</u> |
| Roads, streets, alleys | 28 Ft. | 53 Ft. |
| Other land traversed by vehicles (such as cultivated field, forest, etc.) | 28 Ft. | 53 Ft. |
| Spaces accessible to pedestrians only | 24 Ft. | 53 Ft. |
| Railroad tracks | 38 Ft. | 53 Ft. |

A relay protection system is used to protect the public safety and welfare as well as equipment and the transmission system. Relay protection is installed for all transmission lines to automatically de-energize the line in the unlikely event that the line or supporting structure fails and the line contacts the ground.

Periodic Maintenance Program on All Transmission Lines

To ensure continued public safety and integrity of service, a periodic maintenance and inspection program is implemented for every transmission line. The program is administered through the use of helicopter patrols, with supplemental foot and structure

climbing patrols. A number of helicopter patrols are performed on all lines annually. The two-man helicopter crew flies parallel, to the left, and above the line so that the observer can look for signs of line damage or deterioration and observe clearances between vegetation and conductors. The observations are included in a report that is forwarded to the appropriate department for corrective action.

Foot and structure climbing patrol programs for a transmission line begin approximately three to five years after the line is energized, unless a helicopter patrol reports a need for earlier action. The frequency of foot patrols varies from once every year to once every several years depending on line type and age.

An assigned foot patroller checks right-of-way conditions, including access roads, bridges, pole washouts, tower footers, vegetation height and clearance to conductors, pole and tower deterioration and, with the use of binoculars, insulators, and condition of hardware.

Identified problems are included in a report that is forwarded to the appropriate department for corrective action.

A scheduled line outage is required to perform an overhead patrol because of "hands-on" inspection of hardware. Overhead patrols are conducted on a schedule determined by line age, operating record, and observed general condition. The necessary repairs are also done during the inspection outage.

Personnel Safety Rules

The following are a few of the PPL safety rules that demonstrate the Company's concern for employee safety:

- Work procedures have been developed to allow work to be performed on energized facilities in a safe manner. When lines or apparatus are removed from service to be worked on, the Energy Control Process system is applied. This system provides that a red tag must be physically placed on the control handle of the de-energized equipment. The red tag may be removed only after proper authorization to energize the equipment. Various other tags are used for limited operations and informational purposes.

Employees will not apply or remove a tag or change the status of tagged equipment unless authorized.

- Temporary safety grounds are used on de-energized facilities for employee safety during maintenance, construction, or reconstruction work. Safety grounds are wires connecting the de-energized facility to an electrical ground. If the facility should be energized, the safety grounds will divert the current directly to ground and reduce the likelihood of personal injury. The conductor size and attachment clamps of temporary safety grounds must be capable of conducting anticipated fault currents. Rubber gloves, rubber sleeves, and additional rubber protective equipment are used as required when applying or removing temporary safety grounds to or from the lines or apparatus to be grounded. An approved nonconductive working stick of sufficient length to allow workers to maintain the following required minimum clearances is used to test that the line has been de-energized and to apply temporary safety grounds:

| <u>Voltage-kV</u> | <u>Minimum Clearance</u> |
|-------------------|--------------------------|
| 138 | 3'-7" |
| 230 | 5'-3" |
| 500 | 11'-3" |

Before applying grounds, a test is done to confirm that the line is de-energized. The voltage test device is checked before and after use to assure reliability. When ground pins are used to establish proper ground points, they are driven to a depth of not less than four feet as near vertical as possible.

- Poles or structures are inspected and examined for structural integrity before climbing. If there is any reason to believe that a pole is unsafe, it is stabilized before work is performed. Appropriate safety gear in the form of body belts, safety straps, hard hats, gloves, etc., is worn by linemen during line work activity.