



BUCKS COUNTY TRANSPORT, INC.

Vincent J. Volpe
Executive Director

Buckingham Green
P.O. Box 510
Holicong, PA 18928

215-794-5554
FAX: 215-794-5564

July 30, 2012

Commonwealth of Pennsylvania
Pennsylvania Public Utility Commission
Attn: David Thompson
PO Box 3265
Harrisburg, Pa 17105-3265

RE: A-00107294- Bucks County Transport, Inc. – Request for Rate increase

Dear Mr. Thompson:

Attached for your review is the additional information you requested to review Bucks County Transport, Inc. request for a rate increase.

- 1) New Tariff with new rates. (originally sent with May 30,2012 package)
- 2) A reconciliation of rate change showing effective and proposed rate.
- 3) A revised *Balance Sheet for the month ending June 30, 2012.*
- 4) A list of vehicles and a depreciation of vehicles as of June 30, 2012
- 5) A revised Income Statement listing as of June 30, 2012, with revised explanation of adjustments.
- 6) A copy of May 30, 2012 cover letter with signed affidavit authorizing the PUC to submit as evidence all financial data and proposed new tariff. Also, highlighted in cover letter is that Bucks County Transport Inc. is a PA Non for Profit Entity, whose Board of Directors serve voluntarily and receive no compensation for their services.
- 7) A spreadsheet listing total trips, vehicles miles and passenger miles intrastate in the Commonwealth of PA for the 12 month proceeding the tariff filing.
- 8) A Copy of a Workers Compensation Invoice, and sample copies of invoices for repairs, services and parts.
- 9) The company's officers, salaries and Job duties.

RECEIVED
BUREAU OF
TECHNICAL UTILITY SERVICES
2012 AUG - 2 AM 8:56

Please let me know if you need any additional information or have any further questions. I can be reached at Jraymond@bctransport.org or 267-843-3604

Sincerely yours;

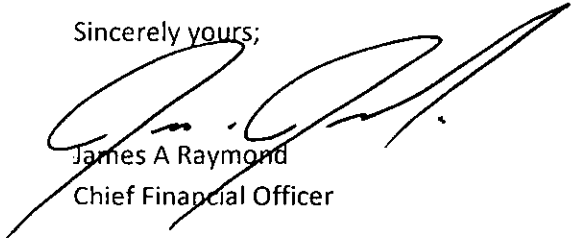
A handwritten signature in black ink, appearing to read 'J. Raymond', written over the typed name and title.

James A Raymond
Chief Financial Officer

Certificate No. A-00107294
Folder 2, Amendment - C

Paratransit Pa. P.U.C. No. 13
Cancels
Paratransit Pa. P.U.C. No. 12
and all Supplements

BUCKS COUNTY TRANSPORT, INC.
RATES AND RULES
GOVERNING THE TRANSPORTATION
OF PASSENGERS IN PARATRANSIT SERVICE
AS SET FORTH HEREIN

ISSUED: May 22, 2012

EFFECTIVE: July 1, 2012

Issued by:

Vincent J. Volpe
Executive Director
Bucks County Transport, Inc.
P.O. Box 510
Holicong, PA 18298

LIST OF CHANGES MADE
BY THIS TARIFF

Paragraph A of the Schedule of Rates is modified to reflect an increase in the rate for one-way trips from \$18.00 to \$19.80, in County; \$32.00 to \$33.80, out of County; and to increase out of County rate for two or more riders from \$27.00 to \$28.80.



SCOPE OF OPERATING AUTHORITY

A-00107294, Folder 2, Am-C

To transport, as a common carrier, persons, in paratransit service, between points in the County of Bucks, and from points in said county, to points in the counties of Northampton, Lehigh, Montgomery and Philadelphia, and vice versa;

subject to the following condition:

- (1) That any service provided under the authority granted herein shall be provided in vehicles having a seating capacity of twenty-eight (28) passengers or less, excluding the driver.
- (2) That no right, power of privilege is granted to originate service from points in the county of Montgomery.

RULES AND REGULATIONS

1. Advance reservations must be made not later than the previous calendar day.
2. Mileage will be determined by the Official Transportation Map of the Commonwealth of Pennsylvania.
3. In instances where the carrier is requested to wait for a passenger or passengers when it is not feasible to dispatch a different vehicle for pick-up of those passengers, an additional charge of \$6.00 will be imposed.
4. Carrier will upon request of passenger(s) allow an escort at no charge upon presentation of a physician's certificate that escort service is required.
5. Senior Citizens:
The rates for senior citizens, having proper identification, will be 15% of the shared ride rate rounded upward to the nearest nickel, provided that the carrier is under contract with the Pennsylvania Department of Transportation under provisions of Section 704 of Act 36 of 1991 (The Lottery Fund Preservation Act).
6. Contract Service:
Contract services provided will be for a term of not less than 30 days for prequalified persons under a federal, state, county or municipal governmental agency contract. Rates for the services will be specified in the respective contracts. Copies of which, including any amendments thereto, are to be filed with the Commission as executed to become effective on one day's notice.

SCHEDULE OF RATES

A. Applicable to the transportation of persons in Paratransit service between points in Bucks County not to exceed 20 miles from point of origin to point of destination. See notes 1 and 2.

NUMBER OF PASSENGER(S)	RATES IN DOLLARS AND CENTS PER ONE-WAY TRIP
1 and over	\$19.80 (A)

Note 1: Passenger(s) transported beyond 20 miles from point of origin will be charged an additional \$1.00 per mile, prorated among applicable number of passengers.

Note 2: For rates applicable to service governed by Rules 5 and 6, see contracts on file.

B. Applicable to the transportation of persons in Paratransit service from points in Bucks County to points in the counties of Northampton, Lehigh, Montgomery and Philadelphia and return (and vice versa from named counties other than Montgomery) not to exceed 50 miles from point of origin to point of destination. See Notes 1 and 2.

NUMBER OF PASSENGER(S)	RATES IN DOLLARS AND CENTS PER ONE-WAY TRIP
1	\$33.80 (A)
2 and over	\$28.80 (A)

Note 1: Passenger(s) transported beyond 50 miles from point of origin will be charged an additional \$1.00 per mile, prorated among applicable number of passengers.

Note 2: For rates applicable to service governed by Rules 5 and 6, see contracts on file.

(A) Indicates increase

Bucks County Transport, Inc.
Detailed Trips Revenue Reconciliation

Old PUC Rate

Requested PUC Rate

Trip Type	Fare	Trips	Total Revenue	Trip Type	Fare	Trips	Total Projected Revenue	Increase
GENERAL PUBLIC TRIPS				GENERAL PUBLIC TRIPS				
In County	\$ 18.00	1,525	\$ 27,450	In County	\$ 19.80	1,397	\$ 27,661	
Out of County (2 or more)	\$ 27.00	98	\$ 2,646	Out of County (2 or more)	\$ 28.80	95	\$ 2,736	
Out of County (1 Person)	\$ 31.00	501	\$ 15,531	Out of County (1 Person)	\$ 33.80	489	\$ 16,528	
Total		2,124	\$ 45,627	Total		1,981	\$ 46,925	\$ 1,298
SUBURBAN SHARED RIDE TRIPS				SUBURBAN SHARED RIDE TRIPS				
In County	\$ 18.00	170,959	\$ 3,077,262	In County	\$ 19.80	165,539	\$ 3,277,672	
Out of County (2 or more)	\$ 27.00	1,776	\$ 47,952	Out of County (2 or more)	\$ 28.80	1,776	\$ 51,149	
Out of County (1 Person)	\$ 31.00	2,272	\$ 70,432	Out of County (1 Person)	\$ 33.80	2,272	\$ 76,794	
Total		175,007	\$ 3,195,646	Total		169,587	\$ 3,405,615	\$ 209,969
PHILADELPHIA SHARED RIDE TRIPS waiver limit \$28.00				PHILADELPHIA SHARED RIDE TRIPS waiver limit \$28.00				
In County	\$ 18.00	-		In County	\$ 19.60	-		
Out of County (2 or more)	\$ 27.00	3,577	\$ 96,579	Out of County (2 or more)	\$ 28.80	3,577	\$ 103,018	
Out of County (1 Person)	\$ 31.00	1,191	\$ 36,921	Out of County (1 Person)	\$ 33.80	1,024	\$ 34,611	
Total		4,768	\$ 133,500	Total		4,601	\$ 137,629	\$ 4,129
Person with disabilities (PWD) waiver limit \$28.00				Person with disabilities (PWD) waiver limit \$28.00				
In County	\$ 18.00	22,677	\$ 408,186	In County	\$ 19.80	22,677	\$ 449,005	
Out of County (2 or more)	\$ 27.00	-	\$ -	Out of County (2 or more)	\$ 28.80	-	\$ -	
Out of County (1 Person)	\$ 31.00	6,841	\$ 212,071	Out of County (1 Person)	\$ 33.80	6,628	\$ 224,026	
Total		29,518	\$ 620,257	Total		29,305	\$ 673,031	\$ 52,774
PUC Fuel Surcharge			\$ 462,791				\$ 523,365	\$ 60,574
Total		211,417	4,457,821	Total		205,474	4,786,568	\$ 328,748

Note: Historically after a PUC fare increase total trips decrease by approximately 3%

Bucks County Transport, Inc.

Balance Sheet - unAudit Balance Sheet

As of 6/30/2012

	<u>CY 2011/2012</u>	<u>LY 2010/2011</u>
Assets		
Current Assets:		
Cash and cash Equivalents	571,092.66	255,383.26
Account Receivable	1,320,630.15	1,732,213.25
Other Assets	<u>85,625.78</u>	<u>87,332.48</u>
Total Current Assets:	1,977,348.59	2,074,928.99
Advances to Employees	0.00	0.00
Fixed Assets		
	6,569,049.27	6,476,773.93
Less Accumulated Depreciation	<u>(5,445,562.54)</u>	<u>(4,918,060.22)</u>
Total Assets	<u>3,100,835.32</u>	<u>3,633,642.70</u>
Liabilities and Unrestricted Net Assets		
Current Liabilities:		
BanK Loan Payable	350,000.00	430,000.00
Current Portion of notes payable	152,494.92	119,786.52
Accounts Payable	380,245.92	593,882.26
Accrued payroll and related expenses	<u>132,854.83</u>	<u>241,023.20</u>
Total Current Liabilities:	1,015,595.67	1,384,691.98
Long Term Liabilities		
Obligations under Capital leases	142,580.06	55,223.39
Notes Payable	<u>77,668.92</u>	<u>62,757.92</u>
Total Long Term Liabilities	220,248.98	117,981.31
Unrestricted Net Assets	<u>1,864,990.67</u>	<u>2,130,969.41</u>
Total Liabilities and Unrestricted Net Assets	<u>3,100,835.32</u>	<u>3,633,642.70</u>

Bucks County Transport, Inc
 Fixed Asset Schedule-Vehicles (15100)
 FY 11/12

<u>Date</u> <u>Acquired</u>	<u>Vehicle #</u>	<u>Asset</u> <u>Description</u>	<u>Cost</u>	<u>Method</u>	<u>Life</u>	<u>Funding</u>	<u>Accum Deprec</u> <u>as of 6/30/11</u>	<u>Accum Deprec</u> <u>as of 6/30/12</u>
11/11/99	654	1999 DODGE VAN	26,000.00	S/L	5 YR	WTW	26,000.00	26,000.00
Removed effective 1/10		2B6KB31Z7XK571161						
11/30/99	656	1999 DODGE VAN	26,000.00	S/L	5 YR	WTW	26,000.00	26,000.00
Removed 11/1/09		2B6KB31Z4XK570114						
12/07/99	389	1999 FORD 16+2WC + LIFT	52,319.00	S/L	5 YR	GRANT	52,319.00	52,319.00
Disposed 11/07		1FDXE40F1XHC22761						
12/07/99	390	1999 FORD 16+2WC + LIFT	52,319.00	S/L	5 YR	GRANT	52,319.00	52,319.00
Removed 4/1/09		1FDXE40F3XHC22762						
12/07/99	391	1999 FORD 16+2WC + LIFT	52,319.00	S/L	5 YR	GRANT	52,319.00	52,319.00
Removed 3/1/09		1FDXE40F5XHC22763						
12/09/99	657	1999 DODGE VAN	26,000.00	S/L	5 YR	BCT	26,000.00	26,000.00
		2B6KB31Z6XK570115						
08/03/00	392	2000 FORD BUS 16+2WC+LIFT	53,028.00	S/L	5 YR	GRANT	53,028.00	53,028.00
		1FDXE45F5YHB55110						
08/03/00	393	2000 FORD BUS 16+2WC+LIFT	53,028.00	S/L	5 YR	GRANT	53,028.00	53,028.00
		1FDXE45F7YHB55111						
08/03/00	394	2000 FORD BUS 16+2WC+LIFT	53,028.00	S/L	5 YR	GRANT	53,028.00	53,028.00
		1FDXE45F9YHB55112						
08/03/00	395	2000 FORD BUS 16+2WC+LIFT	53,028.00	S/L	5 YR	GRANT	53,028.00	53,028.00
		1FDXE45F0YHB55113						
08/31/00	661	1998 FORD VAN	9,636.00	S/L	5 YR	SHRD	9,636.00	9,636.00
Removed 12/1/06		2FMDA51U5WBB41033						
08/31/00	662	1998 FORD VAN	9,636.00	S/L	5 YR	SHRD	9,636.00	9,636.00
Disposed 11/07		2FMDA51U0WBB41036						
08/31/00	663	1998 FORD VAN	9,636.00	S/L	5 YR	SHRD	9,636.00	9,636.00
Disposed 11/07		2FMDA51U8WBB47537						
08/31/00	664	1998 FORD VAN	9,636.00	S/L	5 YR	SHRD	9,636.00	9,636.00
Disposal 6/07 (Totalled)		2FMDA51UXWBB47538						
08/31/00	665	1998 FORD VAN	9,636.00	S/L	5 YR	SHRD	9,636.00	9,636.00
Disposed 11/07		2FMDA51U3WBB60177						
02/15/01	801	2001 FORD BUS, 16 + 2WC	53,028.00	S/L	5 YR	DART	53,028.00	53,028.00
		1FDXE45F21HA11133						
02/15/01	802	2001 FORD BUS, 16 + 2WC	53,028.00	S/L	5 YR	DART	53,028.00	53,028.00
		1FDXE45F41HA11134						
04/03/01	850	2001 DODGE VAN, 15 SEATS	28,000.00	S/L	5 YR	WTW	28,000.00	28,000.00
Removed effective 1/10		2B6KB31Z51K525870						
04/06/01	851	2001 DODGE VAN, 15 SEATS	28,000.00	S/L	5 YR	WTW	28,000.00	28,000.00
Removed effective 1/10		2B6KB31Z11K525249						
07/02/01	396	2001 FORD BUS, 6 + 3WC	43,744.20	S/L	5 YR	GRANT	43,744.20	43,744.20
		1FDXE45F41HA97402	3,936.80	S/L	5 YR	BCT	3,936.80	3,936.80
07/02/01	397	2001 FORD BUS, 6 + 3WC	43,744.20	S/L	5 YR	GRANT	43,744.20	43,744.20
		1FDXE45F61HA97403	3,936.80	S/L	5 YR	BCT	3,936.80	3,936.80
07/02/01	398	2001 FORD BUS, 12 + 2WC	43,744.20	S/L	5 YR	GRANT	43,744.20	43,744.20
		1FDXE45F81HA97404	4,165.80	S/L	5 YR	BCT	4,165.80	4,165.80
07/02/01	399	2001 FORD BUS, 12 + 2WC	43,744.20	S/L	5 YR	GRANT	43,744.20	43,744.20
		1FDXE45F1HA97405	4,165.80	S/L	5 YR	BCT	4,165.80	4,165.80
08/28/01	803	2000 CHEVROLET BUS	43,000.00	S/L	5 YR	DART	43,000.00	43,000.00
		1GBJG31F5Y1252700						
10/03/01	667	1998 FORD WINDSTAR VAN	10,069.54	S/L	5 YR	BCT	10,069.54	10,069.54
Removed effective 2/9/10		2FMZA5144WBE26778						
10/03/01	668	1998 FORD WINDSTAR VAN	10,069.54	S/L	5 YR	BCT	10,069.54	10,069.54
Disposed 11/07		2FMZA5144WBE26781						
10/03/01	669	1998 FORD WINDSTAR VAN	10,069.54	S/L	5 YR	BCT	10,069.54	10,069.54
Removed effective 1/10		2FMZA5148WBE26783						
10/03/01	670	1998 FORD WINDSTAR VAN	10,069.54	S/L	5 YR	BCT	10,069.54	10,069.54
		2FMZA5147WBE26788						
10/03/01	671	1998 FORD WINDSTAR VAN	10,069.54	S/L	5 YR	BCT	10,069.54	10,069.54
Removed 6/09		2FMZA5140WBE26776						
10/03/01	672	1998 FORD WINDSTAR VAN	10,069.54	S/L	5 YR	BCT	10,069.54	10,069.54
Disposed 11/07		2FMZA5142WBE26777						
10/03/01	673	1998 FORD WINDSTAR VAN	10,069.54	S/L	5 YR	BCT	10,069.54	10,069.54
Removed effective 6/30/07		2FMZA5148WBE26779						
10/03/01	674	1998 FORD WINDSTAR VAN	10,069.54	S/L	5 YR	BCT	10,069.54	10,069.54
Disposed 11/07		2FMZA5141WBE26785						
10/03/01	675	1998 FORD WINDSTAR VAN	10,069.54	S/L	5 YR	BCT	10,069.54	10,069.54
Removed effective 6/30/07		2FMZA5146WBE26782						
10/03/01	676	1998 FORD WINDSTAR VAN	10,069.54	S/L	5 YR	BCT	10,069.54	10,069.54
Disposed 11/07		2FMZA5142WBE26780						
10/03/01	678	1998 FORD WINDSTAR VAN	10,069.54	S/L	5 YR	BCT	10,069.54	10,069.54
Disposed 11/07		2FMZA5145WBE26787						
10/03/01	679	1998 FORD WINDSTAR VAN	10,069.54	S/L	5 YR	BCT	10,069.54	10,069.54
Totalled effective 12/08		2FMZA5143WBE26786						
12/03/01	101	2001 FORD BUS, 12 + 3WC	58,429.00	S/L	5 YR	GRANT	58,429.00	58,429.00
		1FDXE45F41HB71742						
12/03/01	102	2001 FORD BUS, 12 + 3WC	58,429.00	S/L	5 YR	GRANT	58,429.00	58,429.00
		1FDXE45F61HB71743						
12/03/01	103	2001 FORD BUS, 12 + 3WC	58,429.00	S/L	5 YR	GRANT	58,429.00	58,429.00
		1FDXE45F81HB71744						
01/02/02	419	2002 FORD BUS, 12 + 3WC	58,429.00	S/L	5 YR	SHRD	58,429.00	58,429.00
Disposal 3/5/07		1FDXE45F82HA09355						
01/02/02	420	2002 FORD BUS, 12 + 3WC	58,429.00	S/L	5 YR	SHRD	58,429.00	58,429.00
Removed 11/09		1FDXE45F12HA09357						
01/29/02	680	1998 FORD WINDSTAR VAN	10,069.54	S/L	5 YR	SHRD	10,069.54	10,069.54
		2FMZA51U7WBB41034						

Bucks County Transport, Inc
 Fixed Asset Schedule-Vehicles (15100)
 FY 11/12

Date Acquired	Vehicle #	Asset Description	Cost	Method	Life	Funding	Accum Deprec as of 6/30/11	Accum Deprec as of 6/30/12
08/15/02	104	Ford Eldorado Aerotech 1FDXE45F12Hb59260	50,244.00	S/L	5 YR	GRANT	50,244.00	50,244.00
08/15/02	105	Ford Eldorado Aerotech 1FDXE45F12Hb59261	50,244.00	S/L	5 YR	GRANT	50,244.00	50,244.00
08/15/02	805	Ford E 450 Phoenix 1FDXE45F82HB27972	55,777.00	S/L	5 YR	GRANT	55,777.00	55,777.00
08/15/02	804	Ford E 450 Phoenix 1FDXE45F82HB27973	55,777.00	S/L	5 YR	GRANT	55,777.00	55,777.00
08/15/02	804	Ford E 450 Phoenix 1FDXE45F82HB27973	55,777.00	S/L	5 YR	GRANT	55,777.00	55,777.00
09/18/03	681	2000 Ford S/W van 2fmza5147ybc60095	9,801	S/L	5 YR	BCT	8,984.25	8,984.25
Totalled-Removed 4/08	682	2000 Ford S/W van 2FMZA5149YBC600096	9,801	S/L	5 YR	BCT	7,514.10	7,514.10
Totalled-Removed 7/07	683	2000 Ford S/W van 2FMZA5147YBC60100	9,801	S/L	5 YR	BCT	7,350.75	7,350.75
Disposal 6/07 (Totalled)	684	2000 Ford S/W van 2FMZA5149YBC60101	9,801	S/L	5 YR	BCT	9,801.00	9,801.00
09/18/03	685	2000 Ford S/W van 2FMZA5142YBC60103	9,801	S/L	5 YR	BCT	9,801.00	9,801.00
09/18/03	686	2000 Ford S/W van 2FMZA5148YBC79738	9,801	S/L	5 YR	BCT	9,801.00	9,801.00
12/04/03	107	2003 Ford Starcraft Allstar 1FDWE45F13HB58624	54,950.00	S/L	5 YR	GRANT	54,950.00	54,950.00
12/04/03	108	2003 Ford Starcraft Allstar 1FDWE45F03HB58632	55,495.00	S/L	5 YR	GRANT	55,495.00	55,495.00
12/04/03	109	2003 Ford Starcraft Allstar 1FDWE45F23HB54436	54,950.00	S/L	5 YR	GRANT	54,950.00	54,950.00
12/04/03	110	2003 Ford Starcraft Allstar 1FDWE45F33HB58625	55,495.00	S/L	5 YR	GRANT	55,495.00	55,495.00
12/04/03	111	2003 Ford Starcraft Allstar 1FDWE45F43HB58634	55,495.00	S/L	5 YR	GRANT	55,495.00	55,495.00
12/04/03	112	2003 Ford Starcraft Allstar 1FDWE45F23HB58633	55,495.00	S/L	5 YR	GRANT	55,495.00	55,495.00
01/01/05	113	2003 FORD E-450 PHOENIX 1FDXE45F13HB58076 - #6968	53,571.00	S/L	5 YR	GRANT	53,571.00	53,571.00
01/01/05	114	2003 FORD E-450 PHOENIX 1FDXE45F33HB58077 - #6969	53,571.00	S/L	5 YR	GRANT	53,571.00	53,571.00
Totalled 02/10/05 Totalled Removed 4/08	687	2001 FORD WINSTAR 2FMZA50481BC24312	7,159.00	S/L	5 YR	BCT	7,159.00	7,159.00
02/10/05	688	2001 FORD WINSTAR 2FMZA50481BB25957	7,159.00	S/L	5 YR	BCT	7,159.00	7,159.00
02/10/05	690	2001 FORD WINSTAR 2FMZA50441BC24310	7,159.00	S/L	5 YR	BCT	7,159.00	7,159.00
02/10/05	692	2001 FORD WINSTAR 2FMZA50441BB25955	7,159.00	S/L	5 YR	BCT	7,159.00	7,159.00
02/10/05	693	2001 FORD WINSTAR 2FMZA50421BB25954	7,159.00	S/L	5 YR	BCT	3,579.50	3,579.50
Totalled effective 8/1/07 02/10/05	689	2001 FORD WINSTAR 2FMZA50451BB25950	7,159.00	S/L	5 YR	BCT	5,488.57	5,488.57
Totalled effective 12/1/08 02/10/05	691	2001 FORD WINSTAR 2FMZA50431BC24315	7,159.00	S/L	5 YR	BCT	7,159.00	7,159.00
Totalled off 7/09	115	2005 FORD E-450 PHOENIX 1FDXE45P45HA23945	60,498.00	S/L	5 YR	GRANT	60,498.00	60,498.00
02/24/05	116	2005 FORD E-450 PHOENIX 1FDXE45P65HA23946	60,498.00	S/L	5 YR	GRANT	60,498.00	60,498.00
02/24/05	117	2005 FORD E-450 PHOENIX 1FDXE45P85HA23947	60,498.00	S/L	5 YR	GRANT	60,498.00	60,498.00
02/24/05	118	2005 FORD E-450 PHOENIX 1FDXE45P65HA59815	60,498.00	S/L	5 YR	GRANT	60,498.00	60,498.00
10/01/05	694	2001 FORD TRUCK 2FTPX14545FB76088	25,086.45	S/L	5 YR	BCT	25,086.45	25,086.45
02/01/06	124	2006 FORD E-450 PHOENIX 1FDXE45P16HB32932	56,504.00	S/L	5 YR	GRANT	56,504.00	56,504.00
02/01/06	125	2006 FORD E-450 PHOENIX 1FDXE45P36HB32933	56,504.00	S/L	5 YR	GRANT	56,504.00	56,504.00
02/01/06	120	2006 FORD E-450 PHOENIX 1FDXE45PX6HB32928	58,504.00	S/L	5 YR	GRANT	58,504.00	58,504.00
02/01/06	121	2006 FORD E-450 PHOENIX 1FDXE45P16HB32929	58,504.00	S/L	5 YR	GRANT	58,504.00	58,504.00
02/01/06	122	2006 FORD E-450 PHOENIX 1FDXE45P86HB32930	58,504.00	S/L	5 YR	GRANT	58,504.00	58,504.00
02/01/06	123	2006 FORD E-450 PHOENIX 1FDXE45PX6HB32931	58,504.00	S/L	5 YR	GRANT	58,504.00	58,504.00
03/01/06	119	2006 FORD E-450 PHOENIX 1FDXE45P16HA97356	6,304.00	S/L	5 YR	BCT	6,304.00	6,304.00
02/01/07	126	2006 FORD Eldorado Aerotech 1FDXE45P86DB18551	60,739.00	S/L	5 YR	GRANT	53,652.78	60,739.00
02/01/07	127	2006 FORD Eldorado Aerotech 1FDXE45P86DB18552	60,739.00	S/L	5 YR	GRANT	53,652.78	60,739.00
02/01/07	128	2006 FORD Eldorado Aerotech 1FDXE45P18DB18553	60,739.00	S/L	5 YR	GRANT	53,652.78	60,739.00
02/01/07	129	2006 FORD Eldorado Aerotech 1FDXE45P36DB18554	60,739.00	S/L	5 YR	GRANT	53,652.78	60,739.00

Bucks County Transport, Inc
 Fixed Asset Schedule-Vehicles (15100)
 FY 11/12

Date Acquired	Vehicle #	Asset Description	Cost	Method	Life	Funding	Accum Deprec as of 6/30/11	Accum Deprec as of 6/30/12
02/01/07	130	2006 FORD Eldorado Aerotech 1FDXE45P56DB18555	60,739.00	S/L	5 YR	GRANT	53,652.78	60,739.00
01/02/02	419	2002 FORD BUS, 12 + 3WV 1FDXE45F82HA09355	(58,429.00)	S/L	5 YR	SHRD	(58,429.00)	(58,429.00)
Disposal 3/5/07								
05/01/07	538	2008 Ford Taurus 1FAPP53U76A208371	11,673.95	S/L	5 YR	BCT	8,335.30	10,298.62
05/01/07	539	2006 Ford Taurus 1FAPP53U06A208356	11,573.95	S/L	5 YR	BCT	8,263.50	10,209.90
05/03/07	131	2006 Ford Challenger 1FDXE45P76DB43781	59,953.00	S/L	5 YR	PWD	49,960.83	59,953.00
05/03/07	132	2006 Ford Challenger 1FDXE45P96DB43782	59,953.00	S/L	5 YR	PWD	49,960.83	59,953.00
05/03/07	133	2006 Ford Challenger 1FDXE45P0DB43783	59,953.00	S/L	5 YR	PWD	49,960.83	59,953.00
05/03/07	134	2006 Ford Challenger 1FDXE45P86DB43790	59,953.00	S/L	5 YR	GRANT	49,960.83	59,953.00
05/03/07	135	2006 Ford Challenger 1FDXE45P96DB43779	59,953.00	S/L	5 YR	GRANT	49,960.83	59,953.00
05/03/07	136	2006 Ford Challenger 1FDXE45P46DB43785	59,953.00	S/L	5 YR	PWD	49,960.83	59,953.00
05/03/07	137	2008 Ford Challenger 1FDXE45P66DB43786	59,953.00	S/L	5 YR	GRANT	49,960.83	59,953.00
05/03/07	138	2006 Ford Challenger 1FDXE45P86DB43787	59,953.00	S/L	5 YR	GRANT	49,960.83	59,953.00
05/03/07	139	2006 Ford Challenger 1FDXE45PX60B43788	59,953.00	S/L	5 YR	GRANT	49,960.83	59,953.00
08/31/00	664	1998 FORD VAN 2FMDA51UXWB847538	(9,636.00)	S/L	5 YR	SHRD	(9,636.00)	(9,636.00)
Disposal 6/07 (Totalled)								
09/18/03	683	2000 Ford SAV van 2FMZA5147YBC60100	(9,801)	S/L	5 YR	BCT	(7,350.75)	(7,350.75)
Disposal 6/07 (Totalled)								
10/03/01	673	1998 FORD WINDSTAR VAN 2FMZA5146WBE26779	(10,069.54)	S/L	5 YR	BCT	(10,069.54)	(10,069.54)
Removed effective 6/30/07								
10/03/01	675	1998 FORD WINDSTAR VAN 2FMZA5148WBE26782	(10,069.54)	S/L	5 YR	BCT	(10,069.54)	(10,069.54)
Removed effective 6/30/07								
02/01/07	695	2003 DODGE (Fr Wheels) 1G8DV13L06D197711	10,000.00	S/L	5 YR	GRANT	8,833.33	10,000.00
02/01/07	696	2006 CHEVY (Fr Wheels) 1G8DV13L16D230344	35,000.00	S/L	5 YR	GRANT	30,916.67	35,000.00
02/01/07	697	2006 CHEVY (Fr Wheels) 1G8DV13L16D230344	35,000.00	S/L	5 YR	GRANT	30,916.67	35,000.00
10/04/96	377	1996 FORD 16+2 WVC 1FDLE40F4THB24820	(52,917.00)	S/L	5 YR	GRANT	(52,917.00)	(52,917.00)
Removed effective 7/6/07								
09/18/03	682	2000 Ford SAV van 2FMZA5149YBC600096	(9,801)	S/L	5 YR	BCT	(7,514.10)	(7,514.10)
Totalled-Removed 7/07								
02/10/05	593	2001 FORD WINDSTAR 2FMZA50421BB25554	(7,159.00)	S/L	5 YR	BCT	(3,579.50)	(3,579.50)
Totalled effective 8/1/07								
10/01/07	600	2005 Dodge Caravan 1D4GP24R85B21451	8,200.00	S/L	5 YR	BCT	6,150.00	7,790.00
10/01/07	601	2005 Dodge Caravan 1D4GP24RX5B21452	8,200.00	S/L	5 YR	BCT	6,150.00	7,790.00
10/01/07	602	2005 Dodge Caravan 1D4GP24RX5B214149	8,200.00	S/L	5 YR	BCT	3,689.99	3,963.33
Totalled 12/09								
10/01/07	603	2005 Dodge Caravan 1D4GP24R65B214147	8,200.00	S/L	5 YR	BCT	6,150.00	7,790.00
10/01/07	604	2005 Dodge Caravan 1D4GP24R45B214146	8,200.00	S/L	5 YR	BCT	6,150.00	7,790.00
10/01/07	605	2005 Dodge Caravan 1D4GP24R25B214145	8,200.00	S/L	5 YR	BCT	6,150.00	7,790.00
10/01/07	606	2005 Dodge Caravan 1D4GP24R95B214143	8,200.00	S/L	5 YR	BCT	6,150.00	7,790.00
10/01/07	607	2005 Dodge Caravan 1D4GP24R75B214142	8,200.00	S/L	5 YR	BCT	6,150.00	7,790.00
10/01/07	608	2005 Dodge Caravan 1D4GP24R55B214141	8,200.00	S/L	5 YR	BCT	6,150.00	7,790.00
10/01/07	609	2005 Dodge Caravan 1D4GP24R35B214140	8,200.00	S/L	5 YR	BCT	6,150.00	7,790.00
10/01/07	658	2005 Dodge Caravan 1D4GP24R55B214138	8,200.00	S/L	5 YR	BCT	6,150.00	7,790.00
10/01/07	699	2005 Dodge Caravan 1D4GP24R55B214124	8,200.00	S/L	5 YR	BCT	6,150.00	7,790.00
10/01/07	700	2005 Dodge Caravan 1D4GP24RX5B214135	8,200.00	S/L	5 YR	BCT	6,150.00	7,790.00
10/01/07	701	2005 Dodge Caravan 1D4GP24R85B214134	8,200.00	S/L	5 YR	BCT	6,150.00	7,790.00
10/01/07	702	2005 Dodge Caravan 1D4GP24R45B214132	8,200.00	S/L	5 YR	BCT	6,150.00	7,790.00
10/01/07	703	2005 Dodge Caravan 1D4GP24R25B214131	8,200.00	S/L	5 YR	BCT	6,150.00	7,790.00
10/01/07	704	2005 Dodge Caravan 1D4GP24R45B214129	8,200.00	S/L	5 YR	BCT	6,150.00	7,790.00
10/01/07	705	2005 Dodge Caravan 1D4GP24R25B214128	8,200.00	S/L	5 YR	BCT	6,150.00	7,790.00
10/01/07	706	2005 Dodge Caravan 1D4GP24R95B21426	8,200.00	S/L	5 YR	BCT	6,150.00	7,790.00

Bucks County Transport, Inc
Fixed Asset Schedule-Vehicles (15100)
FY 11/12

<u>Date Acquired</u>	<u>Vehicle #</u>	<u>Asset Description</u>	<u>Cost</u>	<u>Method</u>	<u>Life</u>	<u>Funding</u>	<u>Accum Deprec as of 6/30/11</u>	<u>Accum Deprec as of 6/30/12</u>
10/01/07	707	2005 Dodge Caravan 1D4GP24R75B21425	8,200.00	S/L	5 YR	BCT	6,150.00	7,790.00
11/03/97	639	1998 DODGE CARAVAN 2W/C 2B4GP25B8WR524184	(28,920.40)	S/L	5 YR	SHRD	(28,920.40)	(28,920.40)
Disposed 11/07								
12/04/00	639	C.I.- REPLACE TRANSMISSION	(1,635.60)	S/L	3 YR	BCT	(1,635.60)	(1,635.60)
11/03/97	640	1998 DODGE CARAVAN 2W/C 2B4GP25BXWR524185	(28,920.40)	S/L	5 YR	SHRD	(28,920.40)	(28,920.40)
Disposed 11/07								
12/07/99	389	1999 FORD 16+2W/C + LIFT 1FDXE40F1XHC22761	(52,319.00)	S/L	5 YR	GRANT	(52,319.00)	(52,319.00)
Disposed 11/07								
08/31/00	662	1998 FORD VAN 2FMDA51U0WBB41036	(9,636.00)	S/L	5 YR	SHRD	(9,636.00)	(9,636.00)
Disposed 11/07								
08/31/00	663	1998 FORD VAN 2FMDA51U8WBB47537	(9,636.00)	S/L	5 YR	SHRD	(9,636.00)	(9,636.00)
Disposed 11/07								
08/31/00	665	1998 FORD VAN 2FMDA51U3WBB60177	(9,636.00)	S/L	5 YR	SHRD	(9,636.00)	(9,636.00)
Disposed 11/07								
10/03/01	668	1998 FORD WINDSTAR VAN 2FMZA5144WBE26781	(10,069.54)	S/L	5 YR	BCT	(10,069.54)	(10,069.54)
Disposed 11/07								
10/03/01	672	1998 FORD WINDSTAR VAN 2FMZA5142WBE26777	(10,069.54)	S/L	5 YR	BCT	(10,069.54)	(10,069.54)
Disposed 11/07								
10/03/01	674	1998 FORD WINDSTAR VAN 2FMZA5141WBE26785	(10,069.54)	S/L	5 YR	BCT	(10,069.54)	(10,069.54)
Disposed 11/07								
10/03/01	676	1998 FORD WINDSTAR VAN 2FMZA5142WBE26780	(10,069.54)	S/L	5 YR	BCT	(10,069.54)	(10,069.54)
Disposed 11/07								
10/03/01	678	1998 FORD WINDSTAR VAN 2FMZA5145WBE26787	(10,069.54)	S/L	5 YR	BCT	(10,069.54)	(10,069.54)
Disposed 11/07								
11/01/07	708	2005 DODGE CARAVAN 1D4GP24R15B214136	8,200.00	S/L	5 YR	BCT	6,013.33	7,653.33
10/04/96	378	1996 FORD 16+2 W/C 1FDLE40F8THB24819	(52,917.00)	S/L	5 YR	GRANT	(52,917.00)	(52,917.00)
Removed effective 4/4/08								
11/10/99	655	1994 MERCURY S/W 1MELM55U6RA624983	(7,674.00)	S/L	5 YR	BCT	(7,674.00)	(7,674.00)
Removed 4/1/08								
09/18/03	681	2000 Ford S/W van 2fma5147ybc60095	(9,801)	S/L	5 YR	BCT	(8,984.25)	(8,984.25)
Totalled-Removed 4/08								
02/10/05	687	2001 FORD WINSTAR 2FMZA50481BC24312	(7,159.00)	S/L	5 YR	BCT	(4,490.98)	(4,490.98)
Totalled, Removed 4/08								
01/30/96	401	1995 FORD 12+2 W/C 1FDKE30F1THA43229	(43,621.00)	S/L	5 YR	SHRD	(43,621.00)	(43,621.00)
Removed effective 6/1/08								
07/01/08	140	2008 FORD E-450 PHOENIX 1FD4E45P08DB05184	64,325.00	S/L	5 YR	GRANT	38,595.00	51,460.00
07/01/08	141	2008 FORD E-450 PHOENIX 1FD4E45P28DB08185	64,325.00	S/L	5 YR	GRANT	38,595.00	51,460.00
07/01/08	142	2008 FORD E-450 PHOENIX 1FD4E45P48DB05186	63,575.00	S/L	5 YR	GRANT	38,145.00	50,860.00
07/01/08	143	2008 FORD E-450 PHOENIX 1FD4E45P68DB09725	63,575.00	S/L	5 YR	GRANT	38,145.00	50,860.00
11/01/08	709	2005 Dodge Grand Caravan 1D4GP24R35B214123	7,000.00	S/L	5 YR	BCT	3,733.33	5,133.33
11/01/08	710	2005 Pontiac Montana 1GMDV03L35D296622	8,447.00	S/L	5 YR	BCT	4,505.07	6,194.47
11/01/08	711	2005 Pontiac Montana 1GMDV03L35D296622	8,447.00	S/L	5 YR	BCT	4,505.07	6,194.47
11/01/08	712	2005 Pontiac Montana 1GMDV03L35D296622	8,447.00	S/L	5 YR	BCT	4,505.07	6,194.47
11/01/08	713	2005 Pontiac Montana 1GMDV03L35D296622	8,447.00	S/L	5 YR	BCT	4,505.07	6,194.47
11/01/08	714	2005 Pontiac Montana 1GMDV03L35D296622	8,447.00	S/L	5 YR	BCT	4,505.07	6,194.47
11/01/08	715	2005 Pontiac Montana 1GMDV03L35D296622	8,447.00	S/L	5 YR	BCT	4,505.07	6,194.47
11/01/08	716	2005 Pontiac Montana 1GMDV03L35D296622	8,447.00	S/L	5 YR	BCT	4,505.07	6,194.47
11/01/08	717	2005 Pontiac Montana 1GMDV03L35D296622	8,447.00	S/L	5 YR	BCT	4,505.07	6,194.47
11/01/08	718	2005 Pontiac Montana 1GMDV03L35D296622	8,447.00	S/L	5 YR	BCT	4,505.07	6,194.47
11/01/08	719	2005 Pontiac Montana 1GMDV03L35D296622	8,447.00	S/L	5 YR	BCT	4,505.07	6,194.47
11/01/08	720	2005 Pontiac Montana 1GMDV03L35D296622	8,447.00	S/L	5 YR	BCT	4,505.07	6,194.47
11/03/97	638	1998 DODGE CARAVAN 2W/C 2B4GP25B6WR524183	(28,920.40)	S/L	5 YR	SHRD	(28,920.40)	(28,920.40)
Removed 12/1/08								
10/11/99	652	1999 DODGE CARAVAN 2B4GP44G7XR378614	(35,654.00)	S/L	5 YR	GRANT	(35,654.00)	(35,654.00)
Removed 12/1/08								
10/11/99	653	1999 DODGE CARAVAN 2B4GP44G3XR378612	(35,654.00)	S/L	5 YR	GRANT	(35,654.00)	(35,654.00)
Removed 12/1/08								
08/31/00	661	1998 FORD VAN 2FMDA51U5WBB41033	(9,636.00)	S/L	5 YR	SHRD	(9,636.00)	(9,636.00)
Removed 12/1/08								
02/10/05	689	2001 FORD WINSTAR 2FMZA50451BB25950	(7,159.00)	S/L	5 YR	BCT	(5,488.57)	(5,488.57)
Totalled effective 12/1/08								
10/03/01	679	1998 FORD WINDSTAR VAN 2FMZA5143WBE26786	(10,069.54)	S/L	5 YR	BCT	(10,069.54)	(10,069.54)
Totalled effective 12/08								
12/01/08	145	2009 Ford Challenger 1FD4E45P08DB59245	64,461.00	S/L	5 YR	BCT	33,304.85	46,197.05
12/01/08	146	2009 Ford Challenger	64,811.00	S/L	5 YR	BCT	33,485.68	46,447.88

Bucks County Transport, Inc
 Fixed Asset Schedule-Vehicles (15100)
 FY 11/12

<u>Date</u> <u>Acquired</u>	<u>Vehicle #</u>	<u>Asset</u> <u>Description</u>	<u>Cost</u>	<u>Method</u>	<u>Life</u>	<u>Funding</u>	<u>Accum Deprec</u> <u>as of 6/30/11</u>	<u>Accum Deprec</u> <u>as of 6/30/12</u>
10/04/96	375	1FD4E45P28DB59246 1996 FORD 10+3 W/C	(54,117.00)	S/L	5 YR	GRANT	(54,117.00)	(54,117.00)
Removed effective 3/1/09								
12/07/99	391	1FDLE40F47HB67134 1999 FORD 18+2WC + LIFT	(52,319.00)	S/L	5 YR	GRANT	(52,319.00)	(52,319.00)
Removed 3/1/09								
09/02/97	381	1FDXE40F5XHC22763 1997 FORD 16+2 W/C	(51,007.00)	S/L	5 YR	GRANT	(51,007.00)	(51,007.00)
Removed 3/1/09								
11/13/00	381	1FDLE40F0VHB19276 C.I.-R&R REAR DIFFER.COVER	(1,696.62)	S/L	3 YR	BCT	(1,696.62)	(1,696.62)
Removed 3/1/09								
12/07/99	390	1999 FORD 16+2WC + LIFT 1FDXE40F3XHC22762	(52,319.00)	S/L	5 YR	GRANT	(52,319.00)	(52,319.00)
Removed 4/1/09								
01/30/96	411	1995 FORD 12+2 W/C 1FDKE30F2THA43255	(43,621.00)	S/L	5 YR	SHRD	(43,621.00)	(43,621.00)
Removed effective 6/09								
01/30/96	406	1995 FORD 7 W/C 1FDKE30F8THA43258	(46,121.00)	S/L	5 YR	SHRD	(46,121.00)	(46,121.00)
Removed effective 6/09								
09/02/97	380	1997 FORD 16+2 W/C 1FDLE40F9VHB19275	(51,007.00)	S/L	5 YR	GRANT	(51,007.00)	(51,007.00)
Removed 6/09								
10/03/01	671	1998 FORD WINDSTAR VAN 2FMZA5140WBE26776	(10,069.54)	S/L	5 YR	BCT	(10,069.54)	(10,069.54)
Removed 6/09								
02/10/05	691	2001 FORD WINSTAR 2FMZA50431BC24315	(7,159.00)	S/L	5 YR	BCT	(6,323.78)	(6,323.78)
Totalled eff 7/09								
01/30/96	403	1995 FORD 12+2 W/C 1FDKE30F3THA43233	(43,621.00)	S/L	5 YR	SHRD	(43,621.00)	(43,621.00)
Removed 8/10/09								
01/30/96	410	1995 FORD 12+2 W/C 1FDKE30F2THA43238	(43,621.00)	S/L	5 YR	SHRD	(43,621.00)	(43,621.00)
Removed 8/10/09								
10/01/09	721	2FMZA51647BA01404	9,485.02	S/L	5 YR	BCT	3,319.76	5,216.76
10/01/09	722	2FMZA51657BA06174	9,485.02	S/L	5 YR	BCT	3,319.76	5,216.76
10/01/09	723	2FMZA51677BA06175	9,485.02	S/L	5 YR	BCT	3,319.76	5,216.76
10/01/09	724	2FMZA51697BA06176	9,485.02	S/L	5 YR	BCT	3,319.76	5,216.76
10/01/09	725	2FMZA51607BA06177	9,485.02	S/L	5 YR	BCT	3,319.76	5,216.76
10/01/09	726	2FMZA51627BA06178	9,485.02	S/L	5 YR	BCT	3,319.76	5,216.76
10/01/09	727	2FMZA51647BA06179	9,485.02	S/L	5 YR	BCT	3,319.76	5,216.76
10/01/09	728	2FMZA51607BA06180	9,485.02	S/L	5 YR	BCT	3,319.76	5,216.76
10/01/09	729	2FMZA51627BA06181	9,485.02	S/L	5 YR	BCT	3,319.76	5,216.76
10/01/09	730	2FMZA51647BA06182	9,485.02	S/L	5 YR	BCT	3,319.76	5,216.76
10/01/09	731	2FMZA51667BA06183	9,485.02	S/L	5 YR	BCT	3,319.76	5,216.76
10/01/09	732	2FMZA51687BA06184	9,485.02	S/L	5 YR	BCT	3,319.76	5,216.76
10/01/09	733	2FMZA516X7BA06185	9,485.02	S/L	5 YR	BCT	3,319.76	5,216.76
10/01/09	734	2FMZA51637BA06187	9,485.02	S/L	5 YR	BCT	3,319.76	5,216.76
10/01/09	735	2FMZA51657BA06188	9,485.02	S/L	5 YR	BCT	3,319.76	5,216.76
10/01/09	736	2FMZA51677BA06189	9,485.02	S/L	5 YR	BCT	3,319.76	5,216.76
10/01/09	737	2FMZA51637BA06190	9,485.02	S/L	5 YR	BCT	3,319.76	5,216.76
10/01/09	738	2FMZA51657BA06191	9,485.02	S/L	5 YR	BCT	3,319.76	5,216.76
10/01/09	739	2FMZA51677BA06192	9,485.02	S/L	5 YR	BCT	3,319.76	5,216.76
10/01/09	740	2FMZA51697BA06193	9,485.02	S/L	5 YR	BCT	3,319.76	5,216.76
10/01/09	147	1FDPE45P79DA24774	68,000.00	S/L	5 YR	GRANT	23,800.00	37,400.00
10/01/09	148	1FDPE45P99DA24775	68,000.00	S/L	5 YR	GRANT	23,800.00	37,400.00
10/01/09	149	1FDPE45P09DA24776	68,000.00	S/L	5 YR	GRANT	23,800.00	37,400.00
10/01/09	150	1FDPE45P29DA24777	68,000.00	S/L	5 YR	GRANT	23,800.00	37,400.00
10/01/09	151	1FDPE45P49DA24778	68,000.00	S/L	5 YR	GRANT	23,800.00	37,400.00
10/01/09	152	1FDPE45P69DA24779	68,000.00	S/L	5 YR	GRANT	23,800.00	37,400.00
10/01/09	153	1FDPE45P29DA24780	68,000.00	S/L	5 YR	GRANT	23,800.00	37,400.00
10/01/09	154	1FDPE45P49DA24781	68,000.00	S/L	5 YR	GRANT	23,800.00	37,400.00
11/30/99	656	1999 DODGE VAN 2B6KB31Z4XK570114	(26,000.00)	S/L	5 YR	WTW	(26,000.00)	(26,000.00)
Removed 11/1/09								
01/02/02	420	2002 FORD BUS, 12 + 3WC	(58,429.00)	S/L	5 YR	SHRD	(58,429.00)	(58,429.00)

Bucks County Transport, Inc
Fixed Asset Schedule-Vehicles (15100)
FY 11/12

<u>Date Acquired</u>	<u>Vehicle #</u>	<u>Asset Description</u>	<u>Cost</u>	<u>Method</u>	<u>Life</u>	<u>Funding</u>	<u>Accum Deprec as of 6/30/11</u>	<u>Accum Deprec as of 6/30/12</u>
Removed 11/09								
10/01/07	602	1FDXE45F12HA09357 2005 Dodge Caravan	(8,200.00)	S/L	5 YR	BCT	(3,689.99)	(3,689.99)
Totaled 12/09								
01/30/96	405	1D4GP24RX5B14149 1995 FORD 12+2 W/C	(43,621.00)	S/L	5 YR	SHRD	(43,621.00)	(43,621.00)
Removed effective 1/10								
01/30/96	409	1FDKE30F0THA43240 1995 FORD 12+2 W/C	(43,621.00)	S/L	5 YR	SHRD	(43,621.00)	(43,621.00)
Removed effective 1/10								
10/14/98	388	1998 FORD 16+2WC + LIFT 1FDXE40F6WHB97693	(49,281.00)	S/L	5 YR	GRANT	(49,281.00)	(49,281.00)
Removed effective 1/10								
11/11/99	654	1999 DODGE VAN 2B6KB31Z7XK571161	(26,000.00)	S/L	5 YR	WTW	(26,000.00)	(26,000.00)
Removed effective 1/10								
04/06/01	851	2001 DODGE VAN, 15 SEATS 2B6KB31Z11K525249	(28,000.00)	S/L	5 YR	WTW	(28,000.00)	(28,000.00)
Removed effective 1/10								
10/03/01	669	1998 FORD WINDSTAR VAN 2FMZA5148WBE26783	(10,069.54)	S/L	5 YR	BCT	(10,069.54)	(10,069.54)
Removed effective 1/10								
04/03/01	850	2001 DODGE VAN, 15 SEATS 2B6KB31Z51K525870	(28,000.00)	S/L	5 YR	WTW	(28,000.00)	(28,000.00)
Removed effective 1/10								
10/03/01	667	1998 FORD WINDSTAR VAN 2FMZA5144WBE26778	(10,069.54)	S/L	5 YR	BCT	(10,069.54)	(10,069.54)
Removed effective 2/9/10								
10/04/96	378	1996 FORD 16+2 W/C 1FDLE40F8THB87136	(52,917.00)	S/L	5 YR	GRANT	(52,917.00)	(52,917.00)
Removed effective 3/20/10								
04/01/10	421	1FDWE38F3XHB97321 2000 FORD	2,500.00	S/L	5 YR	BCT	625.00	1,125.00
12/01/10								
		1FDFE4FS3ADA78905 2010 FORD E-450 PHOENIX	75,952.00	S/L	5 YR	BCT	8,861.07	24,051.47
		1FDFE4FS1ADA78899 2010 FORD E-450 PHOENIX	65,237.00	S/L	5 YR	BCT	7,610.98	20,658.38
		1FDFE4FSXADA78898 2010 FORD E-450 PHOENIX	65,237.00	S/L	5 YR	BCT	7,610.98	20,658.38
		1FDFE4FSSADA78906 2010 FORD E-450 PHOENIX	75,952.00	S/L	5 YR	BCT	8,861.07	24,051.47
		1FDFE4FS7ADA748907 2010 FORD E-450 PHOENIX	75,952.00	S/L	5 YR	BCT	8,861.07	24,051.47
		1FDFE4FS1ADA78904 2010 FORD E-450 PHOENIX	75,952.00	S/L	5 YR	BCT	8,861.07	24,051.47
		1FDFE4FS4ADA78900 2010 FORD E-450 PHOENIX	65,237.00	S/L	5 YR	BCT	7,610.98	20,658.38
		1FDFE4FS6ADA78896 2010 FORD E-450 PHOENIX	65,237.00	S/L	5 YR	BCT	7,610.98	20,658.38
		1FDFE4FS8ADA78897 2010 FORD E-450 PHOENIX	65,237.00	S/L	5 YR	BCT	7,610.98	20,658.38
09/02/97	379	1997 FORD 16+2 W/C 1FDLE40F7VHB19274	(51,007.00)	S/L	5 YR	GRANT	(51,007.00)	(51,007.00)
Removed 02/11								
09/02/97	382	1997 FORD 16+2 W/C 1FDLE40F2VHB19277	(51,007.00)	S/L	5 YR	GRANT	(51,007.00)	(51,007.00)
Removed 2/11								
10/14/98	385	1998 FORD 16+2WC + LIFT 1FDXE40F0WHB97690	(50,281.00)	S/L	5 YR	GRANT	(50,281.00)	(50,281.00)
Removed 2/11								
10/14/98	386	1998 FORD 16+2WC + LIFT 1FDXE40F2WHB97691	(49,281.00)	S/L	5 YR	GRANT	(49,281.00)	(49,281.00)
Removed 2/11								
10/14/98	387	1998 FORD 16+2WC + LIFT 1FDXE40F4WHB97692	(49,281.00)	S/L	5 YR	GRANT	(49,281.00)	(49,281.00)
Removed 2/11								
01/30/96	402	1995 FORD 12+2 W/C 1FDKE30FXTHA43231	(43,621.00)	S/L	5 YR	SHRD	(43,621.00)	(43,621.00)
REMOVED 02/11								
09/17/98	402	REPLACE TRANS. ASSEMBLY	(1,568.00)	S/L	3 YR	BCT	(1,568.00)	(1,568.00)
Transferred from Veh. Cap. Improv. Sch. 6/30/00	REMOVED 2/11							
01/30/96	404	1995 FORD 12+2 W/C 1FDKE30F5THA43234	(43,621.00)	S/L	5 YR	SHRD	(43,621.00)	(43,621.00)
REMOVED 02/11								
01/30/96	408	1995 FORD 12+2 W/C 1FDKE30F7THA43249	(43,621.00)	S/L	5 YR	SHRD	(43,621.00)	(43,621.00)
REMOVED 02/11								
12/17/97	413	1997 FORD 5 W/C 1FDKE30F9VHB82799	(45,835.00)	S/L	5 YR	SHRD	(45,835.00)	(45,835.00)
Removed 2/11								
11/08/00	413	C.I.-R&R REAR DIFFERENTIAL	(2,193.04)	S/L	3 YR	BCT	(2,193.04)	(2,193.04)
12/17/97	414	1997 FORD 5 W/C 1FDKE30F7VHB82798	(45,835.00)	S/L	5 YR	SHRD	(45,835.00)	(45,835.00)
Removed 2/11								
02/01/06	123	2006 FORD E-450 PHOENIX	(58,504.00)	S/L	5 YR	GRANT	(58,504.00)	(58,504.00)
10/1/20011	154	1FDFE45P49DA247B1 F-150 TRUCK	32,295.30	S/L	5 YR	BCT	0.00	4,844.30
11/01/11	741	1GNDV34WX8D200426 2008 CHEV ORLANDER	11,692.95	S/L	5 YR	BCT	0.00	1,559.06
11/01/11	742	1GNDV323W18D200623 2008 CHEV ORLANDER	11,692.95	S/L	5 YR	BCT	0.00	1,559.06
11/01/11	743	1GNDV23W380200543 2008 CHEV ORLANDER	11,692.95	S/L	5 YR	BCT	0.00	1,559.06
11/01/11	744	1GNDV23W08D200919	11,692.95	S/L	5 YR	BCT	0.00	1,559.06
		Total	5,530,493.43					4,578,740.40

BUCKS COUNTY TRANSPORT, INC.
PUC FARE INCREASE UNAUDITED 01/1/2012 REVENUE AND EXPENDITURES

Expense Allocation Methodology	NON PUC		PUC Related		Projections	
	Ending 6/30/2012 Total	2012 Total	PARA Transit 2012	Adjustments	PARA Transit	
General public	\$ 45,627		\$ 45,627	\$ 1,298	\$ 46,925	
Suburban Shared Ride	\$ 3,195,417		\$ 3,195,417	\$ 209,969	\$ 3,405,385	
Philadelphia Shared Ride	\$ 133,505		\$ 133,505	\$ 4,129	\$ 137,634	
Persons with Disabilities	\$ 620,280		\$ 620,280	\$ 52,774	\$ 673,054	
PUC Fuel Surcharge	\$ 462,791		\$ 462,791	\$ 60,574	\$ 523,365	
Non PUC Revenues	\$ 5,919,525	\$ 5,919,525				
Total	\$ 10,377,145	\$ 5,919,525	\$ 4,457,620	\$ 328,744	\$ 4,786,362	

Non Puc Revenues		Contract with	Amount
Medical Assistance Transportation		County	2,937,278
MH/MR Transportation		County	2,049,844
Welfare to Work		State/County	251,099
(1) Shuttle (Reverse Commute Transportation)		TMA	\$ 681,305
			<u>5,919,525</u>

Salaries And Benefits	Direct/indirect(Hours)	\$ 3,969,422	\$ 2,183,182	\$ 1,786,240	\$ 53,587	\$ 1,839,827	(2)	3%
Contracted Services	Direct	\$ 3,611,018	\$ 2,202,416	\$ 1,408,603	\$ 145,030	\$ 1,553,633	(3)	10%
Depreciation	Direct/indirect(Miles)	\$ 135,471	\$ 75,127	\$ 60,344		\$ 60,344		
Vehicle Fuels	Direct/indirect(Miles)	\$ 905,856	\$ 503,410	\$ 402,446	\$ -	\$ 402,446	(4)	0%
Insurance	Direct/Indirect (Trips)	\$ 495,274	\$ 295,283	\$ 199,991	\$ 67,401	\$ 267,392		34%
Interest	Indirect(Trips)	\$ 29,251	\$ 16,829	\$ 12,422	\$ -	\$ 12,422		
Professional Fees	Indirect(Trips)	\$ 107,203	\$ 56,410	\$ 50,793	\$ 6,000	\$ 56,793	(5)	12%
Utilities	Indirect(Trips)	\$ 97,896	\$ 63,336	\$ 34,560	\$ -	\$ 34,560		
Materials and Supplies	Indirect(Trips)	\$ 86,840	\$ 55,893	\$ 30,947	\$ -	\$ 30,947		
Rent	Indirect(Trips)	\$ 191,826	\$ 95,913	\$ 95,913	\$ 1,918	\$ 97,831	(6)	2%
Repair and Maintenance	Direct/indirect(Miles)	\$ 571,451	\$ 318,205	\$ 253,246	\$ 12,662	\$ 265,908	(7)	5%
Other Expenses	Direct/Indirect(Trips)	\$ 226,807	\$ 77,382	\$ 149,425	\$ 14,833	\$ 164,258	(8)	10%
Total Operating Expenses		\$ 10,428,314	\$ 5,943,384	\$ 4,484,930	\$ 301,432	\$ 4,786,362		
Over/ (Under)		\$ (51,169)	\$ (23,859)	\$ (27,310)	\$ 27,312	\$ 0		

**EXPLANTION OF ADJUSTMENTS AND PROJECTED YEAR
(PUC Portion)**

1. Revenue – explained under projected revenue schedule
2. Salaries and Benefits – increase of \$53,587 is primarily due to a 3% across the board raise effective 7/1/11
3. Contracted services –increase of \$145,030 is due to a \$1.00 increase per trip which are provided by the contractors (145,030 trips x \$1.00 per trip)
4. Insurance increase of \$67,401 or 23%. Is due to the following:
 - a. Auto insurance increase of \$22,400 or 15% which is due to an increase to insure 14 additional vehicles for the shared ride program (150 vs. 164)
 - b. Worker compensation insurance increase of \$45,001 or 34% is primarily due to the Workers Compensation Board reclassification of BCT drivers from an 817 (bus operations) to 828 (Para transit operation) category. Also over the last several years BCT has experienced higher than expected worker's compensation claims.
5. Professional Fees - increase of \$6,000 is primarily due to the following for professional services:
 - a. Legal cost of \$4,000 associated with protesting Para-transit rights in Bucks County.
 - b. Increase in Audit Fees of \$2,000 due to new audit regulations.
6. Rent – increase of 2% is due to the Doylestown terminal office rate increasing from \$25.94 to \$25.91 per SQFT.
7. Repairs and Maintenance – is expected to increase by 5% or \$12,662 this increase is due the additional preventative maintenance cost associated with an increase in fleet size. (150 vs. 164)
8. Other expenses – expecting an increase of 11% or \$14,833 primarily due primarily the following:
 - a. \$10,500 cost to purchase of 14 new two way radio for the buses
 - b. \$4,363 increase in PUC assessment due to projected increased revenue



BUCKS COUNTY TRANSPORT, INC.

Vincent J. Volpe
Executive Director

Buckingham Green
P.O. Box 510
Holicong, PA 18928

215-794-5554
FAX: 215-794-5564

May 30, 2012

Rosemary Chiavetta, Secretary
Pennsylvania Public Utility Commission
Common Wealth Keystone Building
400 North Street
Harrisburg, PA 17120

Dear Ms. Chiavetta,

RE: Revised Cover letter and Tariff

Bucks County Transport, Inc. (BCT) is submitting this letter and the accompanying supporting details for the purpose of requesting an increase to our Para transit tariff currently on file. The proposed change will increase our rate for In- County Shared Ride trip rate from \$18.00 to \$19.80; Group Out of County Shared Ride trip rate from \$27.00 to \$28.80 and our Individual Out of County trips rate from \$32.00 to \$33.80. Bucks County Transport, Inc. will continue to charge the current fuel surcharge until further notice from the PUC.

The newly filed tariff, as indicated on the accompanying schedule of the proposed Rate Change, is scheduled to become effective upon the approval by the Public Utility Commission as of July 1, 2012. BCT's largest single source of revenue is derived from the Shared Ride Program, which is subject to PUC jurisdiction. Other non-PUC regulated revenues are generated from contracts with the Pennsylvania Department of Welfare, Bucks County Transportation Management Association and the County of Bucks or entities thereof.

As you know, it has become very difficult to operate our shared ride program on a break-even basis with this economic environment in which we currently live. Over the last year, BCT has experienced double digit percentage increases in insurance expenses. For instance, this year we are expecting to have to absorb an additional 38% increase in Workers Compensation Insurance.

Therefore, we are requesting approval of our proposed increase as a necessary step in enabling BCT to achieve financial stability in carrying out the Shared Ride Program. Enclosed with this letter you will also find the following supporting data required by 52 PA Code sec. 23.63,23.64 and 23.61.

1. Schedule of proposed rate change
2. Balance Sheet as of February 29, 2012
3. Schedule of Fixed Assets as of February 29, 2012 with Book Values
4. Projected Income statement for fiscal Year End February 29, 2012, with adjustments and Projected fiscal year ending June 30, 2012.
5. Explanations of Adjustments
6. Affidavit of Executive Director of Bucks County Transport, Inc.
7. Public Notice of proposed Rate increase.
8. Map of Service Area (Bucks County)

The following information is also submitted in support of the filing:

1. Bucks County Transport, inc. is a PA Non Profit entity, whose Board of Directors serve voluntarily and receives no compensation for their services.
2. In the event of any proceeding before the Public Utility Commission with respect to the proposed rate, it is agreed that the tariff and the financial data submitted therewith will be offered in evidence as an exhibit.
3. BCT does not maintain a depreciation reserve account since the majority of our vehicles are received through State grant programs.

We respectfully request that the commission approve our newly filed tariffs as submitted, based upon the details submitted in support of this request.

Very truly yours;

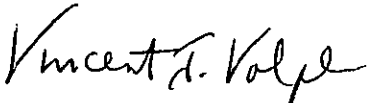

Vincent. J. Volpe
Executive Director

AFFIDAVIT(Corporation)

Vincent J. Volpe being duly sworn (affirmed) according to
(Affiant)

law, deposes and says that he is Executive Director of
(Office of Affiant)

Bucks County Transport, Inc. ; that he is authorized to and does make this
(Name of Corporation)

affidavit for it; and that the facts set forth above (are true and correct; or are true and correct to the best of his knowledge, information and belief) and he expects the said

Bucks County Transport, Inc. to be able to prove the same at the hearing
(Name of Corporation)

hereof.

Vincent J. Volpe
Vincent J. Volpe

Sworn and subscribed before me
this 23rd day of April
2012.

Grace H. McCausland
(Signature of Official administering oath)

My Commission Expires:

COMMONWEALTH OF PENNSYLVANIA
Notarial Seal
Grace H. McCausland, Notary Public
Buckingham Twp., Bucks County
My Commission Expires Sept. 19, 2013
Member, Pennsylvania Association of Notaries

Exhibit E-1

SHARED-RIDE EXPENSE AND OPERATING STATISTICS SUMMARY

(Complete if applicant does not have to allocate or has to allocate but does not have fixed-route)

NAME OF APPLICANT: BUCKS COUNTY TRANSPORT, INC.

CURRENT DATE:

FISCAL YEAR 2011-2012 Estimated

	2011/2012	2011/2012	2011/2012
	TOTAL	SHARED-RIDE	Other
OPERATING STATISTICS			
1. Total Passenger Trips***	560,758	205,474	355,284
2. Cost/Pass. Trip	19.13	\$23.29	\$16.73
3. Total 65+ Trips***	174,198	174,198	
4. Avg. Lottery Reimb. Per Trip	\$17.47	\$14.47	
5. Total Vehicle Miles***	4,600,124	2,057,096	2,543,028
6. Cost/Vehicle Mile	2.33	\$2.33	\$2.34
7. Rev./Vehicle Mile	2.33	\$2.33	\$2.33
8. Total Live Vehicle Miles***	2,622,071	1,172,545	1,449,526
9. Cost/Live Vehicle Mile	\$4.09	\$4.08	\$4.10
10. Rev./Live Vehicle Mile	\$4.08	\$4.08	\$4.08
11. Ratio Live Veh. Miles/Veh. Miles	57%	57%	57%
12. Paid Driver Hours***	185,444	90,533	94,911
13. Passengers/Paid Driver Hour	3.02	2.3	3.7
14. Cost/Paid Driver Hour	\$57.86	\$52.87	\$62.62
15. Revenue/Paid Driver Hour	\$57.73	\$52.87	\$62.37
16. Total Passenger Miles***#	5,950,013	1,828,719	4,121,294
17. Cost/Passenger Mile	\$1.80	\$2.62	\$1.44
18. Revenue/Passenger Mile	\$1.80	\$2.62	\$1.44
19. Live Vehicle Hours***	120,539	58,846	61,692
20. Cost/Live Vehicle Hour	\$89.02	\$81.34	\$96.34
21. Rev./Live Vehicle Hour	\$88.82	\$81.34	\$95.95
22. Ratio Live Veh. Hours/Paid Driver Hours	65%	65%	65%
23. Passengers/Live Vehicle Hour	4.7	3.5	5.8
24. Total Number Vehicles	130	130	125
25. Average Trip Length		8.9	11.6



JUL 20 REC'D
JUL 21 ENT'D

PRAETO

PRAETORIAN INSURANCE COMPANY
88 PINE ST
WALL STREET PLAZA
NEW YORK NY 10005

NOTICE OF PREMIUM DUE

POSTED
7-22-11

Due Date: Upon Receipt

Minimum Due: 56,865.95

Bill To:
BUCKS COUNTY TRANSPORT INC
PO BOX 510
HOLICONG PA 18928 USA

Policy Number: QWC4000620
Policy Term: 7/01/2011 to
7/01/2012

Named Insured & Address:
BUCKS COUNTY TRANSPORT INC
PO BOX 510
HOLICONG PA 18928 USA

PAYMENT INFORMATION

Gross Premium: \$ 284,329.88
Payments Received: \$
Total Balance: \$ 284,329.88

* Includes processing fees

Thank you for choosing
PRAETORIAN INSURANCE COMPANY
Questions about this bill?
CALL BILLING SERVICES @ 800-609-0401

Agent: A0005 (410)828-5810
ALL RISKS LTD
10150 YORK ROAD
5TH FLOOR
HUNT VALLEY MD 21030

You must pay the minimum due or total balance by the due date to avoid a lapse in coverage or cancellation of policy.

Please do not cut, staple or fold this coupon. Mail this coupon with your remittance to:



QWC4000620070111 80

Policy Number QWC4000620	Billing Date 7/09/2011	Total Balance 284,329.88
Policy Effective Date 7/01/2011	Due Date Upon Receipt	Minimum Due 56,865.95

Include your policy number on the check or money order

Enter the amount of your payment \$ _____



Named Insured: BUCKS COUNTY TRANSPORT INC

PRAETORIAN INSURANCE COMPANY
P.O. BOX 5438
NEW YORK, NY 10087-5438

*OLC for
7/20/11*

Agent #
A0005

DBJLLOBE(06/2003)

July

13100-000

BUCKS COUNTY TRANSPORT, INC.

47525

Payee PRAETORIAN INSURANCE COMPANY

47525

Vendor ID PRAETO

Account #: QWC4000620

7/25/2011

Invoice	Description	Discount	Amount
070911	July Invoices	\$0.00	\$56,865.95
Total :		\$0.00	\$56,865.95



Faulkner-Ciocca



CUSTOMER #: 2155362522
UNIT# BU130

421402

INVOICE

BUCKS COUNTY TRANSPORT
515 SOUTH WEST END BLVD
QUAKERTOWN, PA 18951

1531 Park Avenue · Quakertown, PA 18951
Tel: (215) 536-5900 · Fax: (215) 892-1365
www.cioccatires.com www.cioccaparts.com
www.fcfordquakertown.com

HOME: 215-536-2522 CONT: N/A

PAGE 1

BUS: CELL: 267-446-7430 SERVICE ADVISOR: 2348 DONNA HESSE

COLOR	YEAR	MAKE/MODEL	VIN	LICENSE / REG. #	MILEAGE IN / OUT	TAG	
	06	FORD E450	1FDXE45P56DB18555		124294 / 124294	T9453	
DEL DATE	PROD DATE	WARR EXP	PROMISED	PO NO	RATE	PAYMENT	INV DATE
01JAN06 DD			17:00 24AUG11	VER# 130	VARI	CASH	06SEP11
R.O. OPENED	READY	OPTIONS: DLR:01355-9 ENG:6.0 Liter EFI					
10:46 24AUG11	09:53 06SEP11						

LINE OPCODE TECH TYPE HOURS LIST NET TOTAL

A CUST STATES: IN AM WHEN STARTING VEH CHUGGED, HARD TO START, DOD START
BLEW WHITE SMOKE, LACK OF POWER
DIAG DTAG, REPLACE EGR COOLER, INJECTORS

304 CF		1519.81	1519.81
1 4C3Z*9P456*AH COOLER EGR	488.17	414.94	414.94
1 3C3Z*6A642*CA KIT	324.00	275.40	275.40
1 3C3Z*6C683*AB FILTER ASY	13.69	11.64	11.64
1 FL*2016* KIT - ELEMENT & GASKET - OIL F	28.75	24.44	24.44
15 15W40 15W40 MOTOR OIL	2.98	2.53	37.95
3 VC*7*B ANTI-FREEZE	15.47	13.15	39.45
3 WATER DISTILLED WATER	6.95	5.91	17.73
4 4C3Z*9E527*BRM REMAN NOZZLE ASY	307.69	261.54	1046.16
2 *W302908* HARDWARE MISCELLANEOUS	20.50	17.42	34.84
1 QAP25060900 BELT	39.94	39.94	39.94
1 5C3Z*9424*C KIT - MANIFOLD HARDWARE	487.77	414.60	414.60
1 3C3Z*12A697*AA SENSOR ASY	29.82	25.35	25.35
FFD6 REPLACE BOTH 6.0 DIESEL FUEL FILTERS		67.96	67.96
304 CF		79.99	79.99
1 FD*4606* ELEMENT			

SEP 7 ENTN

124294 VARIFIED CONCERN FOUND AFTER DIAG THAT THE EGR SYSTEMM IS FAILING DUE TO EXTENDED IDLEING AND A SLIGHT MISFIRE ON CYL 6 REPLACED ALL THE INJECTORS ON LEFT SIDE 2 4 6 AND 8 REPLACED THE DUMMY PLUGS ON BOTH SIDE WITH UPDATED PARTS REPLACED THE MANIFOLD DUE TO BLOCKED EGR PORTS FROM CARBON THAT COULD NOT BE CLEANED AND REPLACED THE EGR COOLER AS WELL AS THE OIL COOLER FLUSHED SYSTEM RECONDITIONED TURBO AND REPLACED REASSEMBLED AND RETESTED OPERATION OK AT THIS TIME

POSTED

B PERFORM MULTI POINT INSPECTION & FREE BATTERY CHECK

99P PERFORM MULTI POINT INSPECTION & FREE BATTERY CHECK

304 CA		0.00	0
GTIRE TIRE CHECK GOOD			
304 CA		0.00	0

59200 - 000 - 000 - 40

WARRANTY DISCLAIMER: ALL PARTS AND ACCESSORIES ARE SOLD AND ALL REPAIRS ARE PROVIDED BY THE DEALERSHIP AS-IS. THE DEALERSHIP HEREBY EXPRESSLY DISCLAIMS ALL WARRANTIES, EXPRESS AND IMPLIED, INCLUDING ANY IMPLIED WARRANTIES OF MERCHANTABILITY AND FITNESS FOR A PARTICULAR PURPOSE, AND NEITHER ASSUMES NOR AUTHORIZES ANY OTHER PERSON TO ASSUME FOR IT ANY LIABILITY IN CONNECTION WITH THE SALE OF PARTS OR PRODUCTS OR THE REPAIR. THE ONLY WARRANTIES ON PARTS AND ACCESSORIES OR REPAIRS ARE THOSE WHICH MAY BE OFFERED BY THE MANUFACTURER OR THE ORIGINAL PARTS DISTRIBUTOR AND ONLY SUCH MANUFACTURER OR DISTRIBUTOR SHALL BE LIABLE FOR PERFORMANCE UNDER SUCH WARRANTIES. CUSTOMER SHALL NOT BE ENTITLED TO RECOVER FROM THE DEALERSHIP ANY CONSEQUENTIAL DAMAGES, DAMAGES TO PROPERTY, DAMAGES FOR LOSS OF USE, LOSS OF TIME, LOSS OF PROFIT OR INCOME, OR ANY OTHER INCIDENTAL DAMAGES.

*SHOP SUPPLY COSTS:	DESCRIPTION	TO
We have added a charge equal to 0% of the total cost of labor and parts, not to exceed \$0.00, in the Misc. Charges amount for shop supplies used in connection with this repair.	LABOR AMOUNT	158
	PARTS AMOUNT	246
	GAS, OIL, LUBE	
	SUBLET AMOUNT	
	MISC. CHARGES *	
	TOTAL CHARGES	40
	LESS INSURANCE	
	SALES TAX	
	PLEASE PAY THIS AMOUNT	

By signing below, you acknowledge that you were notified of and authorized the Dealership to perform the services/repairs itemized in this invoice and that you received (or had the opportunity to inspect) any replaced parts as requested by you. The vehicle is being returned to you in exchange for your payment of the Amount Due.

ALL PARTS ARE NEW UNLESS OTHERWISE INDICATED

CUSTOMER SIGNATURE: *Chen K. ...*
AUTHORIZED DEALERSHIP REPRESENTATIVE SIGNATURE: *Donna Hesse*



11N C O L N
MERCURY

SERVICE

EXTENDED SERVICE PLAN
Genuine Ford ESP

Yes No

Owner Advantage Rewards
Member #:
Service Balance:

Multi-Point Inspection Report Card as Recommended by Ford Motor Company

Name: BTC RASH BOWMAN
E-Mail Address: _____

Today's Date: _____ RO/Tag: 421402 State: _____
Make/Model/Year: _____ Mileage: _____
VIN #: _____ Plate #: _____

SCHEDULED MAINTENANCE ITEMS DUE			
DUE	SERVICED	DUE	SERVICED
THE WORKS FUEL SAVER PACKAGE	<input type="checkbox"/>	Engine Air Filter	<input checked="" type="checkbox"/>
<input checked="" type="checkbox"/> Oil Change & Filter	<input checked="" type="checkbox"/>	Engine Coolant	<input type="checkbox"/>
<input checked="" type="checkbox"/> Tire Rotation	<input type="checkbox"/>	Transmission Fluid &/or Filter	<input type="checkbox"/>
<input type="checkbox"/> Multi-Point Inspection	<input type="checkbox"/>	Cabin Air Filter	<input checked="" type="checkbox"/>
Fuel Filter	<input type="checkbox"/>	Spark Plugs	<input checked="" type="checkbox"/>

*This is only a partial list of vehicle maintenance items and is NOT all-inclusive. Please consult your Owners Manual or visit www.genuineservice.com for vehicle specific maintenance requirements.

CHECK FLUID LEVELS AND/FILL			
OK	FILL	OK	FILL
<input checked="" type="checkbox"/>	<input type="checkbox"/>	<input checked="" type="checkbox"/>	<input type="checkbox"/>
Engine Oil	Power Steering	Transmission (if equipped with dipstick)	Coolant Recovery Reservoir
<input checked="" type="checkbox"/>	<input type="checkbox"/>	<input checked="" type="checkbox"/>	<input type="checkbox"/>
Brake Reservoir	Window Washer		

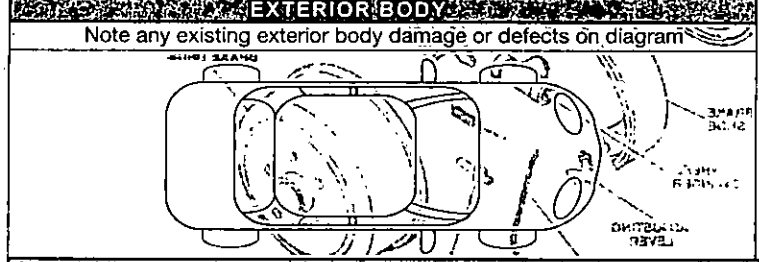
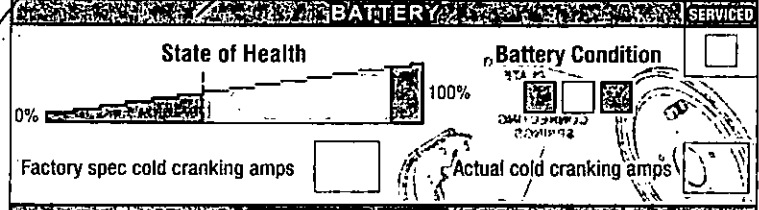

SYNC VEHICLE HEALTH REPORT (VHR)			
VHR Activation	<input type="checkbox"/> Yes	<input type="checkbox"/> No	<input type="checkbox"/> N/A

LEGEND: May contribute to vehicle efficiency and promote a greener environment
 Checked and OK at this time May require future attention Requires immediate attention

CHECK FOLLOWING SYSTEMS/COMPONENTS			
BRAKE SYSTEM			
<input checked="" type="checkbox"/>	<input type="checkbox"/>	Brake system (including lines, hoses, and parking brake)	<input type="checkbox"/>
STEERING AND SUSPENSION			
<input checked="" type="checkbox"/>	<input type="checkbox"/>	Shocks/struts and other suspension components for leaks and/or damage	<input type="checkbox"/>
<input checked="" type="checkbox"/>	<input type="checkbox"/>	Steering, steering linkages and ball joints	<input type="checkbox"/>
EXHAUST SYSTEM			
<input checked="" type="checkbox"/>	<input type="checkbox"/>	Exhaust system (leaks, damage, loose parts)	<input type="checkbox"/>
TRANSMISSION AND DRIVE AXLE			
<input checked="" type="checkbox"/>	<input type="checkbox"/>	Clutch operation (if equipped)	<input type="checkbox"/>
<input checked="" type="checkbox"/>	<input type="checkbox"/>	Constant velocity (CV) drive axle boots (if equipped)	<input type="checkbox"/>
<input checked="" type="checkbox"/>	<input type="checkbox"/>	Drive shaft, transmission, u-joint and shift linkage (if equipped) and lubricate (as needed)	<input type="checkbox"/>
LIGHTS/BLADES/WINDSHIELD			
<input checked="" type="checkbox"/>	<input type="checkbox"/>	Operation of horn, interior lights, exterior lamps, turn signals, hazard and brake lamps	<input type="checkbox"/>
<input checked="" type="checkbox"/>	<input type="checkbox"/>	Windshield washer spray, wiper operation and wiper blades	<input type="checkbox"/>
<input checked="" type="checkbox"/>	<input type="checkbox"/>	Windshield for cracks, chips and pitting	<input type="checkbox"/>
BELTS/HOSES/MOUNTS			
<input checked="" type="checkbox"/>	<input type="checkbox"/>	HVAC system and hoses/lines for leaks and/or damage	<input type="checkbox"/>
<input checked="" type="checkbox"/>	<input type="checkbox"/>	Engine Cooling System, radiator, hoses and clamps	<input type="checkbox"/>
<input checked="" type="checkbox"/>	<input type="checkbox"/>	Accessory drive belt(s)	<input type="checkbox"/>

TIRE/BRAKE WEAR

TIRE TREAD	7/32" and greater	4/32" to 6/32"	3/32" and less	
BRAKE LINING	Over 5mm or 7/32" (Disc) or Over 2mm or 3/32" (Drum)	3 to 5mm or 4/32" to 7/32" (Disc) or 1.01 to 2mm (Drum) or 2/32" to 3/32"	Less than 3mm or 4/32" (Disc) or 1mm or 2/32" or less (Drum)	
 TIRE WEAR INDICATES: <input type="checkbox"/> Alignment check needed <input type="checkbox"/> Wheel balance needed <input type="checkbox"/> Tire repair needed <input checked="" type="checkbox"/> Brake measurements not taken this service visit <input type="checkbox"/> TIRE RECALLS <input type="checkbox"/> Check for open tire recalls	LEFT FRONT	SERVICED	RIGHT FRONT	SERVICED
	<input checked="" type="checkbox"/>	<input type="checkbox"/>	<input checked="" type="checkbox"/>	<input type="checkbox"/>
	Tire Tread Depth <u>12</u> /32" Tire Age _____	<input type="checkbox"/>	Tire Tread Depth <u>2</u> /32" Tire Age _____	<input type="checkbox"/>
	Tire Wear Pattern/Damage _____	<input type="checkbox"/>	Tire Wear Pattern/Damage _____	<input type="checkbox"/>
<input checked="" type="checkbox"/>	<input type="checkbox"/>	<input checked="" type="checkbox"/>	<input type="checkbox"/>	
Tire Pressure - set to factory recommended PSI _____	<input type="checkbox"/>	Tire Pressure - set to factory recommended PSI _____	<input type="checkbox"/>	
<input checked="" type="checkbox"/>	<input type="checkbox"/>	<input checked="" type="checkbox"/>	<input type="checkbox"/>	
Brake Lining _____ mm _____ /32"	<input type="checkbox"/>	Brake Lining _____ mm _____ /32"	<input type="checkbox"/>	
LEFT REAR	SERVICED	RIGHT REAR	SERVICED	
<input checked="" type="checkbox"/>	<input type="checkbox"/>	<input checked="" type="checkbox"/>	<input type="checkbox"/>	
Tire Tread Depth <u>13</u> /32" Tire Age _____	<input type="checkbox"/>	Tire Tread Depth <u>2</u> /32" Tire Age _____	<input type="checkbox"/>	
Tire Wear Pattern/Damage _____	<input type="checkbox"/>	Tire Wear Pattern/Damage _____	<input type="checkbox"/>	
<input checked="" type="checkbox"/>	<input type="checkbox"/>	<input checked="" type="checkbox"/>	<input type="checkbox"/>	
Tire Pressure - set to factory recommended PSI _____	<input type="checkbox"/>	Tire Pressure - set to factory recommended PSI _____	<input type="checkbox"/>	
<input checked="" type="checkbox"/>	<input type="checkbox"/>	<input checked="" type="checkbox"/>	<input type="checkbox"/>	
Brake Lining _____ mm _____ /32"	<input type="checkbox"/>	Brake Lining _____ mm _____ /32"	<input type="checkbox"/>	
SPARE TIRE	SERVICED			
<input checked="" type="checkbox"/>	<input type="checkbox"/>	Tire Pressure - set to factory recommended PSI _____	<input type="checkbox"/>	

Be sure to visit FordOwner.com today!

Comments: _____

Advisor: _____ Tech: _____

Customer Signature: _____

12-74300835

BUCKS COUNTY TRANSPORT, INC.

48612

Payee FAULKNER-CIOCCA FORD MERCURY

48612

Vendor ID FAULKN

-Account #:

10/10/2011

Invoice	Description	Discount	Amount
421397	August Invoices	\$0.00	\$85.39
421402	Veh #130	\$0.00	\$4,050.20
421440	veh 722	\$0.00	\$172.98
421459	veh 724	\$0.00	\$591.58
421491	veh 726	\$0.00	\$111.12
421584	VEH 163	\$0.00	\$95.87
Total :		\$0.00	\$5,107.14

PRODUCT DLM102 USE WITH 91500 ENVELOPE

Deluxe For Business 1-800-257-8354

PRINTED IN U.S.A.

A



Faulkner-Ciocca

**FORD · MERCURY
MITSUBISHI SERVICE CENTER**

CUSTOMER #: 2155362522
UNIT# BTC135

421523

INVOICE

TO BE SURE.

1531 Park Avenue
Quakertown, PA 18951
Tel: (215) 536-5900 · Fax: (215) 536-1474
www.faulknerfordmercury.com
www.faulknermitsubishi.net

BUCKS COUNTY TRANSPORT
515 SOUTH WEST END BLVD
QUAKERTOWN, PA 18951
HOME: 215-536-2522 CONT: N/A

PAGE 2

BUS: CELL: 267-446-7430 SERVICE ADVISOR: 2348 DONNA HESSE

COLOR	YEAR	MAKE/MODEL	VIN	LICENSE	MILEAGE IN/OUT	TAG	
WHITE	06	FORD E450	1FDXE45P96DB43779		106754/106754	T9265	
DEL DATE	PROD DATE	WARR EXP	PROMISED	PO NO	RATE	PAYMENT	INV DATE
01JAN06 DD			17:00 06SEP11		VARI	CASH	06SEP11
R.O. OPENED	READY	OPTIONS: DLR:01355-9 ENG:6.0 Liter_EFI					

LINE	OPCODE	TECH	TYPE	HOURS	LIST	NET	TOTAL
C**	REPLACE BOTH 6.0 DIESEL FUEL FILTERS						
	FFD6 REPLACE BOTH 6.0 DIESEL FUEL FILTERS						
	282 CA					67.96	67.96
	1 FD*4606* ELEMENT				79.99	79.99	79.99
	106754 REPLACE BOTH FUEL FILTERS						

CUSTOMER PAY	HAZARDOUS WASTE FOR REPAIR ORDER						1.55

SEP 7 ENT

Jeh 135

59200-000-000-40

POSTED

Oliver R. Spynak
Tue 06 SEPT 2011
VEN# 135

LIMITED LABOR WARRANTY
The Repair Facility warrants the labor used in performing the repairs listed on the front of the Repair Order for a period of 90 days or 4,000 miles (whichever comes first) from the date such repairs were completed. This Limited Warranty specifically excludes: front end alignments, electrical wiring and shorts, and fuel system - when due to contamination. This Limited Warranty is extended to the vehicle owner/customer and is not transferable to, nor enforceable by any other person.
During the duration of the Limited Warranty, the Repair Facility will provide additional labor, at no expense to customer, for any additional repairs that are necessitated as a result of any defect in labor performed while completing the repairs listed on the front of the Repair Order.
To obtain repairs under this Limited Warranty, customer must: (a) notify the Repair Facility at the address shown on the front of this Repair Order within five (5) days of notice of such defect in labor; (b) deliver the vehicle to the Repair Facility at the address shown on the front of this Repair Order within a reasonable time after customer discovers or should have discovered any such defect. Such notice, however, must be given to the Repair Facility before the end of the duration period of this Limited Warranty, as specified above; (c) authorize the Repair Facility to make repairs required; and (d) pay the charges for any additional parts required together with sales tax upon completion of such repair.
All implied warranties, including the implied warranties of merchantability and fitness for a particular purpose, are limited to the duration period of this Limited warranty. Under no circumstances will the Repair Facility be liable to customer for any incidental or consequential damages including, but not limited to, damages for loss of property, loss of vehicle use, loss of time, loss of income and profits, inconvenience of commercial loss.
This part is sold "as is". The only warranties applying to this part are those which may be offered by the manufacturer(s). The selling dealer hereby expressly disclaims all warranties of merchantability or fitness for a particular purpose, and neither assumes nor authorizes any other person to assume for it any liability in connection with the sale of this part and/or service. Buyer shall not be entitled to recover from the selling dealer any consequential damages, damages to property, damages for loss of use, loss of time, loss of profits, or income, or any other incidental damages. In addition, expressly excluded is any dealer liability for defects pertaining to safety or performance, by way of "strict liability", negligence or otherwise.
The dealer warrants to the original purchaser, retail, fleet, and wholesaler, that Ford parts and accessories found to be defective in factory-supplied material or workmanship will be repaired, replaced or exchanged, log. Parts and accessories for Ford, Mercury, and Lincoln cars, and light trucks: 12 months or 12,000 miles whichever comes first. Parts and accessories for 600 and higher series trucks: 12 months/unlimited miles.
The only requirement of the purchaser is to return the defective parts or accessory to the dealer's place of business during regular business hours for repair or replacement. The purchaser must have the original counter sale receipt or repair order for a dealer installed part or accessory in order to validate the date and mileage on the vehicle at the date of sale or installation of the original part or accessory.
If the purchaser is traveling or has moved to a different locality, any authorized Ford Motor Company dealer will fulfill this warranty.
THIS WARRANTY DOES NOT COVER PARTS AND ACCESSORIES THAT FAIL DUE TO ABUSE, MISUSE, NEGLIGENCE, ALTERATION, ACCIDENT, RACING, OR THE USE OF NON-FORD PARTS, OR PARTS WHICH ARE REPAIRED AS PARTS OF NORMAL MAINTENANCE.
TO THE EXTENT ALLOWED BY LAW, LOSS OF TIME, INCONVENIENCE, LOSS OF USE OF THE VEHICLE, COMMERCIAL LOSS OR CONSEQUENTIAL DAMAGES ARE NOT COVERED.
THERE IS NO OTHER EXPRESSED WARRANTY OF FORD MOTOR COMPANY SUPPLIED REPLACEMENT PARTS AND ACCESSORIES.
ANY IMPLIED WARRANTY OF MERCHANTABILITY OR FITNESS IS LIMITED TO THE DURATION OF THIS WRITTEN WARRANTY.
SOME STATES DO NOT ALLOW THE EXCLUSION OF LIABILITY OF CONSEQUENTIAL OR INCIDENTAL DAMAGES OR LIMITATION ON HOW LONG AN IMPLIED WARRANTY LASTS; THEREFORE, THE ABOVE LIMITATION AND EXCLUSIONS MAY NOT ALWAYS APPLY. THIS WARRANTY GIVES YOU SPECIFIC LEGAL RIGHTS. YOU MAY ALSO HAVE OTHER RIGHTS WHICH VARY FROM STATE TO STATE.

DESCRIPTION	TOTALS
LABOR AMOUNT	1150.31
PARTS AMOUNT	2797.56
GAS, OIL, LUBE	0.00
SUBLET AMOUNT	0.00
MISC. CHARGES	1.55
TOTAL CHARGES	3949.42
LESS INSURANCE	0.00
SALES TAX	0.00
PLEASE PAY THIS AMOUNT	3949.42

IN CASE OF ACCIDENT
CALL (215) 536-8700

CUSTOMER COPY

Faulkner-Ciocca

**FORD MERCURY
MITSUBISHI SERVICE CENTER**

TO BE SURE.

1531 Park Avenue

Quakertown, PA 18951

Tel: (215) 536-5900 Fax: (215) 536-1474

www.faulknerfordmercury.com

www.faulknermitsubishi.net

CUSTOMER #: 2155362522
UNIT# BTC135

421523

INVOICE

BUCKS COUNTY TRANSPORT
515 SOUTH WEST END BLVD
QUAKERTOWN, PA 18951

PAGE 1

HOME:215-536-2522 CONT:N/A

BUS: CELL:267-446-7430 SERVICE ADVISOR: 2348 DONNA HESSE

COLOR	YEAR	MAKE/MODEL	VIN	LICENSE	MILEAGE IN/OUT	TAG	
WHITE	06	FORD E450	1FDXE45P96DB43779		106754/106754	T9265	
DEL DATE	PROD DATE	WARR EXP	PROMISED	PO NO	RATE	PAYMENT	INV DATE
01JAN06 DL			17:00 06SEP11		VARI	CASH	06SEP11

R/O OPENED: READY OPTIONS: DLR:01355-9 ENG:6.0 Liter_EFI

LINE	OPCODE	TECH	TYPE	HOURS	LIST	NET	TOTAL
------	--------	------	------	-------	------	-----	-------

A CUST STATES POSS SERP BELT BROKE

DIAG DIAG, REPLACE AC COMPRESSOR, TENSIONERS

BELTS

282 CF

1039.87 1039.87

1	3C2Z*6B209*CA	TENSIONER	197.84	168.16	168.16
1	3C2Z*6B209*BA	TENSIONER	180.81	153.69	153.69
1	4C3Z*8A616*AA	CLUTCH ASY - FAN	470.38	399.82	399.82
1	8C2Z*8B614*B	SHROUD - FAN	276.23	234.80	234.80
1	4C2Z*19V703*AC	COMPRESSOR ASY	766.74	651.73	651.73
1	YN*12*D	OIL - COMPRESSOR - AIR CONDITI	23.98	20.38	20.38
60	YN*19*	REFRIGERANT - R-134A	1.79	1.52	91.20
2	XC4Z*19D990*AA	AIR CONDITIONER	7.72	6.56	13.12
1	4C2Z*19C836*AB	ACCUMULATOR ASY - AIR			
		CONDITIO	194.70	165.49	165.49
1	6C2Z*19D850*BA	TUBE - COMPRESSOR TO MANIFOLD	327.90	278.71	278.71
2	F8VZ*19E773*AB	KIT - AIR CONDITIONING SYSTEM	76.52	65.04	130.08
1	6C2Z*6C640*AA	CONNECTION - AIR INLET	101.65	86.40	86.40
1	QAP2581298	BELT	104.75	53.79	53.79
1	QAP25060915	BELT	85.40	43.85	43.85
1	6C2Z*6C640*A	CONNECTION - AIR INLET	103.17	87.69	87.69
1	QAP25060905	BELT	68.84	68.84	68.84
2	VC*7*B	ANTI-FREEZE	15.47	15.47	30.94
2		WATER DISTILLED WATER	6.95	6.95	13.90

106754 VERIFY BOTH BELTS BROKE FIND MAIN A/C COMPRESSOR FROZEN

REMOVE ORFICE TUBE FIND CLOGGED WITH METAL FROM COMPRESSOR REPLACE A/C

COMPRESSOR INSTALL NEW BELTS AND TENSIONERS ALSO INSTALLED FAN SHROUD

AND FAN CLUTCH WAS DAMAGED WHEN BELTS BROKE REPLACE ORFICE TUBE FLUSH

A/C SYSTEM EVAC AND CHARGE ROAD TEST OK NAPA BELT #'S 081298 AND 060905

B REPLACE 6.0 DIESEL HEPA AIR FILTER

AFD6 REPLACE 6.0 DIESEL HEPA AIR FILTER

282 CA

42.48 42.48

1	FA*1804*	ELEMENT ASY - AIR CLEANER	24.98	24.98	24.98
---	----------	---------------------------	-------	-------	-------

106754 REPLACE AIR FILTER

LIMITED LABOR WARRANTY
The Repair Facility warrants the labor used in performing the repairs listed on the front of the Repair Order for a period of 90 days or 4,000 miles (whichever comes first) from the date such repairs were completed. This Limited Warranty specifically excludes front end alignments, electrical wiring and shorts, and fuel system - when due to contamination. This Limited Warranty is extended to the vehicle owner/customer and is not transferable to, nor enforceable by any other person.
During the duration of the Limited Warranty, the Repair Facility will provide additional labor, at no expense to customer, for any additional repairs that are necessitated as a result of any defect in labor performed while completing the repairs listed on the front of the Repair Order.
To obtain repairs under this Limited Warranty, customer must: (a) notify the Repair Facility at the address shown on the front of this Repair Order at the address shown on the front of the Repair Order of any defect in labor within a reasonable time after customer discovers or should have discovered any such defect. Such notice, however, must be given to the Repair Facility before the end of the duration period of this Limited Warranty, as specified above; (b) deliver the vehicle to the Repair Facility at the address shown on the front of this Repair Order within five (5) days of notice of such defect in labor; (c) authorize the Repair Facility to make repairs required; and (d) pay the charges for any additional parts required together with sales tax upon completion of such repair.
All implied warranties, including the implied warranties of merchantability and fitness for a particular purpose, are limited to the duration period of this Limited Warranty. Under no circumstances will the Repair Facility be liable to customer for any incidental or consequential damages including, but not limited to, damages for loss of property, loss of vehicle use, loss of time, loss of income and profits, inconvenience or commercial loss.
This part(s) is sold "as is". The only warranties applying to this part(s) are those which may be offered by the manufacturer(s). The selling dealer hereby expressly disclaims all warranties of merchantability or fitness for a particular purpose, and neither assumes nor authorizes any other person to assume for it any liability in connection with the sale of this part(s) and/or service. Buyer shall not be entitled to recover from the selling dealer any consequential damages, damages to property, damages for loss of use, loss of time, loss of profits, or income, or any other incidental damages. In addition, expressly excluded is any dealer liability for defects pertaining to safety or performance, by way of "strict liability", negligence or otherwise.
The dealer warrants to the original purchaser, retail, fleet, and wholesaler, that Ford parts and accessories found to be defective in factory-supplied material or workmanship will be repaired, replaced or exchanged for: * Parts and accessories for Ford, Mercury, and Lincoln cars, and light trucks: 12 months or 12,000 miles whichever comes first. * Parts and accessories for 600 and higher series trucks: 12 months/unlimited miles.
The only requirement of the purchaser is to return the defective parts or accessory to the dealer's place of business during regular business hours for repair or replacement. The purchaser must have the original counter sale receipt or repair order for a dealer installed part or accessory in order to validate the date and mileage on the vehicle at the date of sale or installation of the original part or accessory.
If the purchaser is moved or has moved to a different location, any authorized Ford Motor Company dealer will fulfill this warranty.
THIS WARRANTY DOES NOT COVER PARTS AND ACCESSORIES THAT FAIL DUE TO ABUSE, MISUSE, NEGLIGENCE, ALTERATION, ACCIDENT, RACING, OR THE USE OF NON-FORD PARTS OR PARTS WHICH ARE REPLACED AS A PART OF NORMAL MAINTENANCE.
TO THE EXTENT ALLOWED BY LAW, LOSS OF TIME, INCONVENIENCE, LOSS OF USE OF THE VEHICLE, COMMERCIAL LOSS OR CONSEQUENTIAL DAMAGES ARE NOT COVERED.
THERE IS NO OTHER EXPRESSED WARRANTY OF FORD MOTOR COMPANY SUPPLIED REPLACEMENT PARTS AND ACCESSORIES.
ANY IMPLIED WARRANTY OF MERCHANTABILITY OR FITNESS IS LIMITED TO THE DURATION OF THIS WRITTEN WARRANTY.
SOME STATES DO NOT ALLOW THE EXCLUSION OF LIMITATION OF CONSEQUENTIAL OR INCIDENTAL DAMAGES OR LIMITATION ON HOW LONG AN IMPLIED WARRANTY LASTS; THEREFORE, THE ABOVE LIMITATION AND EXCLUSIONS MAY NOT ALWAYS APPLY. THIS WARRANTY GIVES YOU SPECIFIC LEGAL RIGHTS. YOU MAY ALSO HAVE OTHER RIGHTS WHICH VARY FROM STATE TO STATE.

DESCRIPTION	TOTALS
LABOR AMOUNT	
PARTS AMOUNT	
GAS, OIL, LUBE	
SUBLET AMOUNT	
MISC. CHARGES	
TOTAL CHARGES	
LESS INSURANCE	
SALES TAX	
PLEASE PAY THIS AMOUNT	

**IN CASE OF ACCIDENT
CALL (215) 536-8700**

CUSTOMER COPY



Ford Service



Extended Service Plan

Yes No

Owner Advantage Rewards

Member #: Service Balance:

Vehicle REPORT CARD - Multi-Point Inspection as recommended by Ford Motor Company

Name: BTC135
E-Mail Address:
Today's Date:

Make/Model/Year: 06 E450
State:
Inspec. Month:
VIN #:
Plate #:

SCHEDULED MAINTENANCE ITEMS table with columns for DUE, SERVICED, and items like Engine Air Filter, Oil Change & Filter, etc.

*This is only a partial list of vehicle maintenance items and is NOT all-inclusive. Please consult your Owner's Manual or visit www.genuineservice.com for vehicle specific maintenance requirements.

FLUID LEVELS table with items like Oil and/or fluid leaks, Engine Oil, Power Steering, etc.

BATTERY table with State of Health gauge and Battery Condition information.

WIPER BLADES table with Wipe Test Performed and Wiper Blades status.

EXTERIOR BODY section with a diagram of the car's exterior and a note to check for damage or defects.

SYNC VEHICLE HEALTH REPORT (VHR) table with VHR Activation status.

LEGEND: May contribute to vehicle efficiency and promote a greener environment. Checked and OK at this time, May require future attention, Requires immediate attention.

SYSTEMS/COMPONENTS

Brake System table with Brake system (including lines, hoses, and parking brake) status.

STEERING/SUSPENSION

Shocks/struts and other suspension components for leaks and/or damage status.

EXHAUST SYSTEM

Exhaust system (leaks, damage, loose parts) status.

TRANSMISSION/DRIVE AXLE

Clutch operation (if equipped) and Constant velocity (CV) drive axle boots status.

LIGHTS/WINDSHIELD

Operation of horn, interior lights, exterior lamps, turn signals, hazard and brake lamps status.

BELTS/HOSES/MOUNTS

HVAC system and hoses/lines for leaks and/or damage status.

Engine Cooling System, radiator, hoses and clamps status.

Accessory drive belt(s) status.

TIRE/BRAKE WEAR

TIRE TREAD and BRAKE LINING measurement tables.

TIRE WEAR INDICATES table with Alignment check needed and Wheel balance needed.

LEFT FRONT and RIGHT FRONT tire and brake measurements.

LEFT REAR and RIGHT REAR tire and brake measurements.

SPARE TIRE measurements.

Comments: section for handwritten notes.

Be sure to visit FordOwner.com today!

Advisor: Tech:

Customer Signature:

12-76186957

BUCKS COUNTY TRANSPORT, INC.

49048

Payee FAULKNER-CIOCCA FORD MERCURY

49048

Vendor ID FAULKN

Account #:

10/24/2011

Invoice	Description	Discount	Amount
421523	veh #135	\$0.00	\$3,949.42
421710	veh #150	\$0.00	\$260.46
421812	veh #723	\$0.00	\$131.07
Total :		\$0.00	\$4,340.95

PRODUCT DLM102 USE WITH 91500 ENVELOPE

Deluxe For Business 1-800-257-8354

PRINTED IN U.S.A.

A



Bucks County International, Inc.

134 Old Oxford Valley Rd.

LANGHORNE, PENNSYLVANIA 19047

Direct Parts Line (267) 397-4006 Sales & Service (267) 397-4000

Fax (215) 493-1061

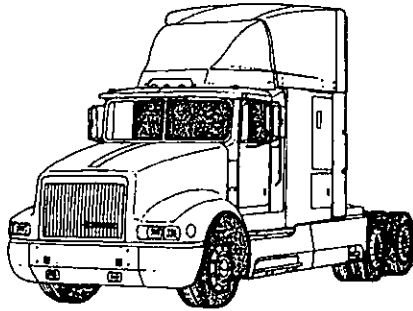

458131



DATE ENTERED 20 SEP 11	YOUR ORDER NO.	DATE SHIPPED 20 SEP 11	INVOICE DATE 20 SEP 11	INVOICE NUMBER 458131
---------------------------	----------------	---------------------------	---------------------------	--------------------------

S
O
L
D

T
O

ACCOUNT NO. 30930

PAGE 1 OF 1

BUCKS COUNTY TRANSPORTATION CO
PO BOX 510 BUCKINGHAM GREEN II
HOLICONG, PA 18928

ROBS TRUCK SHOP

Bus #112

SHIP VIA	SLSM. 55	B/L NO.	TERMS W-CHARGE	F.O.B. POINT LANGHORNE, PA
----------	-------------	---------	-------------------	-------------------------------

ORD.	SHIP	EQ.	PART NO	DESCRIPTION	LIST	NET	AMOUNT
7	7	0	1831487C93	KIT	301.04	240.83	1,685.81
			CORE EXCHANGE			150.00	1,050.00
1	1	0	1833646C92	PACKAGE	301.04	240.83	240.83
			CORE EXCHANGE			150.00	150.00
2	2	0	1830844C93	HARNES	54.02	34.73	69.46
2	2	0	1826703C1	GASKET	106.00	60.57	121.14
2	2	0	1827535C94	KIT	29.91	19.56	39.12

POSTED
SEP 28

Best Unit #112

ENTERED
9/27/11

59200-000-000-94

- * - * - SEP - OCT SPECIALS - * - * -
+ CONGRATULATION GENE "RED" HIEBER
+ 2012 PA TRUCK DEALER OF THE YEAR! !
= AM/FM CD PLAYER PANASONIC \$114.95 =
PARTS HRS M/F 7:30-6:00 SAT 8:30-2:00

CUSTOMER'S SIGNATURE
X *Edward Hieber*

PARTS	3,356.36
SUBLET	
FREIGHT	0.00
SALES TAX	0.00
TOTAL	\$3,356.36

NO RETURN ON ELECTRICAL OR SPECIAL ORDER ITEMS. PARTS MUST BE RETURNED WITHIN 10 DAYS.
ALL RETURNS SUBJECT TO 20% HANDLING CHARGE. ORIGINAL INVOICE MUST ACCOMPANY ALL RETURNS.

BUCKS COUNTY TRANSPORT, INC.

48598

Payee BUCKS COUNTY INTERNATIONAL, INC.

48598

Vendor ID : BCINTL

Account #:

10/10/2011

Invoice	Description	Discount	Amount
448826	CORE RETURN CREDIT	\$0.00	(\$450.00)
451267	CORE RETURN	\$0.00	(\$300.00)
458131	INJECTOR KIT FOR BUS #112	\$0.00	\$3,356.36
Total :		\$0.00	\$2,606.36

PRODUCT DLM102 USE WITH 91500 ENVELOPE

Deluxe For Business 1-800-257-8354

PRINTED IN U.S.A.

A



Bucks County International, Inc.

134 Old Oxford Valley Rd.

LANGHORNE, PENNSYLVANIA 19047

Direct Parts Line (267) 397-4006 Sales & Service (267) 397-4000

Fax (215) 493-1061

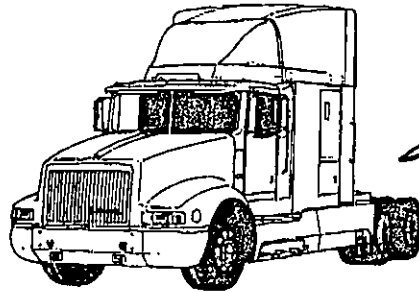

#801
465901

DATE ENTERED 19 JAN 12	YOUR ORDER NO. 801	DATE SHIPPED 19 JAN 12	INVOICE DATE 19 JAN 12	INVOICE NUMBER 465901
---------------------------	-----------------------	---------------------------	---------------------------	--------------------------

SOLD TO ACCOUNT NO. 30930 SHIP TO PAGE 1 OF 1
 BUCKS COUNTY TRANSPORTATION CO ROBS TRUCK SHOP
 PO BOX 510 BUCKINGHAM GREEN II
 HOLICONG, PA 18928

SHIP VIA	SLSM.	B/L NO.	TERMS	F.O.B. POINT		
	55		W-CHARGE	LANGHORNE, PA		
QTY	UNIT	PART NO.	DESCRIPTION	LIST	NET	AMOUNT
1	EA	1831487C93	KIT	301.04	240.83	1,926.64
			CORE EXCHANGE		150.00	1,200.00
2	EA	1830844C93	HARNESSES	54.61	35.11	70.22
2	EA	1826703C1	GASKETS	106.00	60.57	121.14
<p>ENTERED 1/24/12</p> <p>59200-000-000-60</p> <p>POSTED JAN 25 12</p>						
+ * + * JAN - FEB SPECIALS + * + * - COBRA CB RADIO \$99.99 - = EXIDE GROUP 31 BATTERY \$69.99 = + SHELL ROTELLA T OIL \$15.69 GAL + PARTS HRS M/F 7:30-6:00 SAT 8:30-2:00				PARTS 3,318.00 SUBLET FREIGHT 0.00 SALES TAX 0.00		
CUSTOMER'S SIGNATURE X <i>[Signature]</i>				TOTAL \$3,318.00		

NO RETURN ON ELECTRICAL OR SPECIAL ORDER ITEMS. PARTS MUST BE RETURNED WITHIN 10 DAYS. ALL RETURNS SUBJECT TO 20% HANDLING CHARGE. ORIGINAL INVOICE MUST ACCOMPANY ALL RETURNS.

BUCKS COUNTY TRANSPORT, INC.

50545

Payee BUCKS COUNTY INTERNATIONAL, INC.

50545

Vendor ID BCINTL

Account #:

2/14/2012

Invoice	Description	Discount	Amount
462407	CORE RETURN CREDIT	\$0.00	(\$300.00)
465901	INJECTORS	\$0.00	\$3,318.00
Total :		\$0.00	\$3,018.00

PRODUCT DL1102 USE WITH 91500 ENVELOPE

Deluxe For Business 1-800-257-8354

PRINTED IN U.S.A.

A



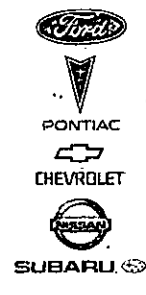

FRED BEANS FORD LINCOLN MERCURY MITSUBISHI
 Route 611 & Sawmill Road
 Doylestown, PA 18901
 (215) 348-2900 Fax (215) 348-9435
 www.fredbeans.com



CELL: 267-221-1314

CUSTOMER NO. 75504	ADVISOR BRUCE PAYNTER	1768	TAG NO. 5250	INVOICE DATE 03/14/12	INVOICE NO. FTCS626457
BUCKS COUNTY TRANSPORT, INC PO BX 510, BUCKINGHAM GRN II HOLICONG, PA 18928-0510	LABOR RATE	LICENSE NO. 721	MILEAGE 121,194	COLOR PEWTER MET/	STOCK NO. F90161P
	YEAR / MAKE / MODEL 07/FORD TRUCK/FREESTAR WAGON/WGN SE			DELIVERY DATE 09/28/09	DELIVERY MILES 62,564
	VEHICLE I.D. NO. 2 F M Z A 15 13 6 4 7 B A 0 1 4 0 4			SELLING DEALER NO.	PRODUCTION DATE 05/05/06
	F.T.E. NO. 232371722			P.O. NO.	
RESIDENCE PHONE 215-794-5554	BUSINESS PHONE 215-794-5554 x506	COMMENTS E# 3.9L OHV EFI		DATE COMPLETED 03/09/12	MILEAGE OUT MO: 121199

TOTALS.....

 * NEXT RECOMMENDED SERVICE: *
 * 05/25/2012 / 126199 MI 31FOZF03.7 *MOBIL LUBE OIL FLTR *

SURF THE WEB WITH FRED BEANS
 VISIT US AT www.fredbeans.com
 ALSO SAVE MONEY ON YOUR NEXT VISIT WITH OUR INTERNET COUPONS
 PLEASE REMEMBER TO RETURN YOUR MANUFACTURERS SURVEY COMPLETE
 WE APPRECIATE YOUR POSITIVE RESPONSE TO FORD MOTOR COMPANY!

 * HOUSE CHARGE [] ACCT#..... *
 * CASH [] CHECK [] #..... *
 * VISA [] MASTERCARD [] AMEX [] *
 * ACCEPTED BY.....DATE..... *

TOTAL LABOR.... 1147.90
 TOTAL PARTS.... 2192.50
 TOTAL SUBLET... 0.00
 TOTAL G.O.G.... 42.50
 TOTAL MISC CHG. 9.95
 TOTAL MISC DISC -334.73
 TOTAL TAX..... 0.00
TOTAL INVOICE \$ 3058.12

YOUR STATE INSPECTION
 EXPIRES _____

TIRES _____ BRAKES _____

ANTIFREEZE PROTECTION

YOUR VEHICLE IS PARKED IN SPOT
 # _____

721

Eduard Hock
 CUSTOMER SIGNATURE

ENTERED
3/21/12

59200-000-000-40

Replaced transmission

Fred Beans
 Everything Auto

The Reynolds and Reynolds Company, EPA834T11WE, C0612137 O (05/10)

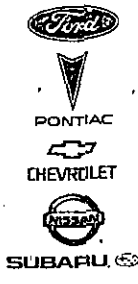

FRED BEANS FORD LINCOLN MERCURY MITSUBISHI
 Route 611 & Sawmill Road
 Doylestown, PA 18901
 (215) 348-2900 Fax (215) 348-9435
 www.fredbeans.com



CELL: 267-221-1314

CUSTOMER NO. 75504	ADVISOR BRUCE PAYNTER	1768	TAG NO. 5250	INVOICE DATE 03/14/12	INVOICE NO. FTGS626457
BUCKS COUNTY TRANSPORT, INC PO BX 510, BUCKINGHAM GRN II HOLICONG, PA 18928-0510	LABOR RATE	LICENSE NO. 721	MILEAGE 121,194	COLOR PEWTER MET/	STOCK NO. F90161P
	YEAR / MAKE / MODEL	07/FORD TRUCK/FREESTAR WAGON/WGN SE		DELIVERY DATE 09/28/09	DELIVERY MILES 62,564
	VEHICLE I.D. NO.	2 F M Z A 15 11 01 4 17 B A 0 1 4 0 4		SELLING DEALER NO.	PRODUCTION DATE 05/05/06
	F.T.E. NO. 232371722	P.O. NO.	03/09/12	REPRINT# 1	
RESIDENCE PHONE 215-794-5554	BUSINESS PHONE 215-794-5554 x506	COMMENTS E# 3.9L OHV EFI	DATE COMPLETED	MILEAGE OUT MO: 121199	

JOB# 1 CHARGES

LABOR
 # 1-15FOZ01 INSPECT TRANSMISSION TECH(S):202 154.95
 CUST STATES THAT THE TRANS LOST ITS FORWARD GEARS EXCEPT
 FIRST GEAR. CHECK AND ADVISE.
 ROAD TEST SELF TEST CODE P0297/P0731.PINPOINT TEST.ELECTRO
 NIC TRANS DIAG.CHECK LINE PRESS OK.TRANS STALL TEST FAILED
 SUSPECT INTERNAL TRANS DAMAGE.REC.REMOVE TRANS.DISASSEMBLE
 AND INSPECT.

MISC-----CODE-----DESCRIPTION-----CONTROL NO-----
 CD CORPORATE DISCOUNT LABOR -15.50
 TOTAL - MISC -15.50

JOB# 1 TOTALS
 LABOR 154.95
 MISC -15.50

JOB# 2 CHARGES
 JOB# 1 JOURNAL PREFIX FTCS JOB# 1 TOTAL 139.45

LABOR
 # 2-98FOZQ99P MULTIPPOINT INSPECTIO TECH(S):202 0.00
 PERFORM COURTESY MULTI POINT INSPECTION
 PERFORMED 27 POINT COURTESY INSPECTION.
 TOPPED OFF FLUIDS AS NEEDED AND SET TIRE PRESSURE.

JOB# 2 TOTALS

JOB# 3 CHARGES
 JOB# 2 JOURNAL PREFIX FTCS JOB# 2 TOTAL 0.00

LABOR
 # 3+15FOZ10 REPL: TRANSMISSION TECH(S):202 992.95
 REPLACE TRANSMISSION
 INTERNAL DAMAGE IN TRANSMISSION.
 REPLACE TRANSMISSION ASSEMBLY
 FLUSH COOLER/LINES, ROADTEST. OK

PARTS	QTY	FP-NUMBER	DESCRIPTION	UNIT PRICE	
	1	5F2Z-7000-BRM	AUTOMATIC TRAN	2169.33	2169.33
	1	765-2614	COOLER CLEAN	23.17	23.17
TOTAL - PARTS					2192.50

G.O.G. & SUPPLIES
 10.0 MPVATF @ 4.250 /UNIT 42.50
 TOTAL - GOG 42.50

MISC-----CODE-----DESCRIPTION-----CONTROL NO-----
 CD CORPORATE DISCOUNT LABOR -99.30
 CDP CORPORATE DISCOUNT PARTS -100.00
 CDP CORPORATE DISCOUNT PARTS -100.00
 CDP CORPORATE DISCOUNT PARTS -19.93

YOUR STATE INSPECTION

EXPIRES _____

TIRES	BRAKES
+	+

ANTIFREEZE PROTECTION

YOUR VEHICLE

IS PARKED

IN SPOT

POSTED
MAR 21 2012

Handwritten signature

The Reynolds and Reynolds Company EBANTHANE C0612137 0 (05/10)

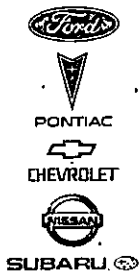

FRED BEANS FORD LINCOLN MERCURY MITSUBISHI

Route 611 & Sawmill Road
 Doylestown, PA 18901
 (215) 348-2900 Fax (215) 348-9435
 www.fredbeans.com



CELL: 267-221-1314

CUSTOMER NO. 75504	ADVISOR BRUCE PAYNTER 1768	TAG NO. 5250	INVOICE DATE 03/14/12	INVOICE NO. FTCS626457
BUCKS COUNTY TRANSPORT, INC PO BX 510, BUCKINGHAM GRN II HOLICONG, PA 18928-0510	LABOR RATE	LICENSE NO. 721	MILEAGE 121,194	COLOR PEWTER MET/ STOCK NO. F90161P
	YEAR / MAKE / MODEL 07 / FORD TRUCK / FREESTAR WAGON / WGN SE		DELIVERY DATE 09/28/09	DELIVERY MILES 62,564
	VEHICLE I.D. NO. 2 FIM Z A 5 1 6 4 7 B A 0 1 4 0 4		SELLING DEALER NO.	PRODUCTION DATE 05/05/06
	P.T.E. NO. 232371722		P.O. NO.	REPRINT# 1
RESIDENCE PHONE 215-794-5554	BUSINESS PHONE 215-794-5554 x506	COMMENTS E# 3.9L OHV EFI	DATE COMPLETED	MILEAGE OUT MO: 121,199

TOTAL - MISC		-319.23
JOB# 3 TOTALS	-----	
	LABOR	992.95
	PARTS	2192.50
	G.O.G.	42.50
	MISC	-319.23
JOB# 4 CHARGES	JOB# 3 JOURNAL PREFIX FTCS	JOB# 3 TOTAL 2908.72
LABOR	-----	
J# 4+36FOZGBATT	BATTERY CONDITION	TECH(S):202 0:00
COMPLIMENTARY BATTERY INSPECTION FOR CONDITION THE STATE OF CHARGE		
RECOMMENDED TO CONSISTANTLY MONITOR BATTERY CONDITION		
HAVE YOUR BATTERY CHECKED AT EVERY VISIT!		
JOB# 4 TOTALS	-----	
JOB# 5 CHARGES	JOB# 4 JOURNAL PREFIX FTCS	JOB# 4 TOTAL 0.00
LABOR	-----	
J# 5+04FOZGTIRE	TIRE CONDITION	TECH(S):202 0:00
COMPLETED INSPECTION OF TIRES FOR CONDITION AND TREAD DEPTH		
CONTINUOUS MONITORING FOR TREAD LIFE		
TIRES ARE WITHING THE "GREEN" MARGINS FOR TREAD LIFE AT THIS TIME. FOLLOW INFLATION PLACARD FOR PROPER INFLATION PRESSURE TO MAXIMIZE LIFE OF THE TIRES.		
JOB# 5 TOTALS	-----	
JOB# 5 JOURNAL PREFIX FTCS	JOB# 5 TOTAL	0.00
MISC	CODE	DESCRIPTION
JOB # A	102	HAZ WASTE SHOP SUPPLIES CHARGE
CONTROL NO		9.95
TOTAL - MISC		9.95

YOUR STATE INSPECTION

EXPIRES _____

TIRES	BRAKES
+	+

ANTIFREEZE PROTECTION

YOUR VEHICLE
IS PARKED
IN SPOT

The Reynolds and Reynolds Company EPA/INTIRVE CB81237 C (05/10)

ESTIMATE
 CUSTOMER HEREBY ACKNOWLEDGES RECEIVING ORIGINAL ESTIMATE OF \$0.00 (+TAX)
 APPROVED REVISED ESTIMATE (# 1) OF \$3330.00 (+TAX) ON 03/13/12 AT 10:00am
 BY ED HACKETT COMMENTS

EA
Fred Beans
 Inspecting & Maintaining

BUCKS COUNTY TRANSPORT, INC.

51675

Payee FRED BEANS FORD-LINCOLN-MERCURY-
Vendor ID FREDBE

Account #:

51675
5/7/2012

Invoice	Description	Discount	Amount
FTCS625729	Veh 156	\$0.00	\$26.90
FTCS626197	Veh 160	\$0.00	\$180.27
FTCS626457	REMOVED AND REPLACED TRANSMISSION ON VAN #721	\$0.00	\$3,058.12
Total :		\$0.00	\$3,265.29

PRODUCT DLM102 USE WITH 91500 ENVELOPE

Deluxe For Business 1-800-257-8354

PRINTED IN U.S.A.

A





127

1939 East Lincoln Highway, Langhorne, PA 19047 215-945-8000 www.mccafferty.com

CELL: 267-446-7430

CUSTOMER NO. 8086	ADVISOR DARRINI ALIBERTO	TAG NO. 2408 4247	INVOICE DATE 11/03/11	INVOICE NO. FOCS338774
BUCKS COUNTY TRANSPORT 2444 DURHAM RD BRISTOL, PA 19007-6902	LABOR RATE	LICENSE NO. BA58036	MILEAGE 106,657	COLOR WHITE/
edhackett@bctransport.org	YEAR / MAKE / MODEL 06/FORD TRUCK/ECONO CUTAWAY/VAN E-45	DELIVERY DATE 01/11/07	DELIVERY MILES	STOCK NO.
RESIDENCE PHONE 215-269-4630	VEHICLE I.D. NO. 1 F D X E 4 5 P X 6 D B 1 8 5 5 2	SELLING DEALER NO.	PRODUCTION DATE 09/06/06	
BUSINESS PHONE 215-946-9357 X702	F.T.E. NO. 23-2371722	P.O. NO.	R.O. DATE 09/29/11	
	COMMENTS E# 109			MO: 106657

TOTALS

[] CASH [] CHECK CK. NO. []

[] VISA [] MASTERCARD [] DISCOVER

[] AMER XPRESS [] OTHER [] CHARGE

TOTAL LABOR	2137.08
TOTAL PARTS	300.49
TOTAL SUBLET	0.00
TOTAL G.O.G.	0.00
TOTAL MISC CHG	372.20
TOTAL MISC DISC	0.00
TOTAL TAX	0.00
TOTAL INVOICE \$	2809.77

DISCLAIMER OF WARRANTIES

The only warranties, if any, applying to the part(s) and/or service are those offered by the manufacturer. The selling dealer hereby expressly disclaims all warranties, either expressed or implied, including any implied warranties of merchantability or fitness for a particular purpose, and neither assumes nor authorizes any other person to assume for it any liability in connection with the sale of this part(s) and/or service. Buyer shall not be entitled to recover from the selling dealer any consequential damages, damages to property, damages for loss of use, loss of time, loss of profits or income, or any other incidental damages.

THANK YOU FOR YOUR BUSINESS!!

Edmund Hackett (Signature)

CUSTOMER SIGNATURE

Bus (127)

ENTERED

59200-000-000-20

IMPORTANT

You may receive a questionnaire from the manufacturer in the next few weeks. If for any reason you cannot grade us completely Satisfied on each question please contact your service advisor.

McCAFFERTY/AUTO/GROUP

Phone: 215-945-8000

www.mccafferty.com

THANK YOU!!

Make your next service appointment on-line at www.mccafferty.com

Reynolds and Reynolds, EVAPORTIME, CC557229 © (08/06)



1939 East Lincoln Highway, Langhorne, PA 19047 215-945-8000 www.mccafferty.com

CELL: 267-446-7430

CUSTOMER NO. 8086	ADVISOR DARRIN ALIBERTO	TAG NO 2408	INVOICE DATE 11/03/11	INVOICE NO. FOCS338774
BUCKS COUNTY TRANSPORT 2444 DURHAM RD BRISTOL, PA 19007-6902 edhackett@bctransport.org	LABOR RATE	LICENSE NO. BA58036	MILEAGE 106,657	COLOR WHITE
	YEAR / MAKE / MODEL 06 / FORD TRUCK / EGONO CUTAWAY / VAN E=45	DELIVERY DATE 01/11/07	DELIVERY MILES	STOCK NO.
	VEHICLE I.D. NO. 1 F D X E 4 5 P X 6 D B 1 8 5 5 2	SELLING DEALER NO.	PRODUCTION DATE 09/06/06	
	F.T.E. NO. 23-2371722	P.O. NO.	R.O. DATE 09/29/11	
RESIDENCE PHONE 215-269-4630	BUSINESS PHONE 215-946-9357 x702	COMMENTS E# 09		MO: 106657

JOB# 3 TOTALS	LABOR	703.95
	PARTS	300.49
JOB# 4 CHARGES		
JOB# 3 JOURNAL PREFIX FOCS	JOB# 3 TOTAL	1004.44

DISCLAIMER OF WARRANTIES
The only warranties, if any, applying to the part(s) and/or service are those offered by the manufacturer. The selling dealer hereby expressly disclaims all warranties, either expressed or implied, including any implied warranties of merchantability or fitness for a particular purpose, and neither assumes nor authorizes any other person to assume for it any liability in connection with the sale of this part(s) and/or service. Buyer shall not be entitled to recover from the selling dealer any consequential damages, damages to property, damages for loss of use, loss of time, loss of profits or income, or any other incidental damages.

LABOR
JOB# 4-13FOZ DIESEL ENG OPS TECH(S): 2539
CUSTOMER STATES THE DIESEL ENGINE IS NOT RUNNING PROPERLY
TSB: 09-08-03

PARTS	QTY	FP NUMBER	DESCRIPTION	UNIT PRICE
	1	4C3Z-9P456-AJ	COOLER	WARRANTY
	1	3C3Z-6A642-CA	KIT	WARRANTY
	1	-W302725	HARDWAR	WARRANTY
	1	3C3Z-9P455-AB	GASKET	WARRANTY
	4	VC-7-8	ANTI-FR	WARRANTY
	3	VC-9	CLEANER	WARRANTY
	1	3C3Z-8575-AA	THERMOS	WARRANTY
	1	FL-2016	KIT - E	WARRANTY
	15	XO-15W40-QSD	OIL - E	WARRANTY
	1	6C3Z-9T515-A	TUBE AS	WARRANTY
	1	3C3Z-6C885-A	RING	WARRANTY
	1	5C3Z-9J460-B	SENSOR	WARRANTY
	1	5C3Z-12224-A	CONNECT	WARRANTY
	2	-W300012	O RING	WARRANTY
	2	-W300012	O RING	WARRANTY
	1	3C3Z-9C623-AA	HOSE -	WARRANTY
	2	3C3Z-9439-AA	GASKET	WARRANTY
			TOTAL - PARTS	10.00

MISC	CODE	DESCRIPTION	CONTROL NO	
		WE WARRANTY DEDUCTABLE - C	338774-04	372.20
			TOTAL - MISC	372.20

JOB# 4 TOTALS	MISC	372.20
JOB# 4 JOURNAL PREFIX FOCS	JOB# 4 TOTAL	372.20

ESTIMATE
CUSTOMER HEREBY ACKNOWLEDGES RECEIVING ORIGINAL ESTIMATE OF \$99.95 (+TAX)

IMPORTANT
You may receive a questionnaire from the manufacturer in the next few weeks. If for any reason you cannot grade us completely Satisfied on each question please contact your service advisor.
MCCAFFERTY AUTO GROUP
Phone: 215-945-8000
www.mccafferty.com
THANK YOU!

Make your next service appointment on-line at www.mccafferty.com

Est

Reynolds and Reynolds, EVAPORATIVE EMISSIONS CONTROL SYSTEMS, 04/06/09

Thank You, We Appreciate Your Business!



1939 East Lincoln Highway, Langhorne, PA 19047 215-945-8000 www.mccafferty.com

CELL: 267-446-7430

CUSTOMER NO. 8086	ADVISOR DARRIN ALBERTO	TAG NO. 2408	INVOICE DATE 11/03/11	INVOICE NO. FOCS338774
BUCKS COUNTY TRANSPORT 2444 DURHAM RD BRISTOL, PA 19007-6902 edhackett@bctransport.org	LABOR RATE	LICENSE NO. IBA58036	MILEAGE 106,657	COLOR WHITE
	YEAR / MAKE / MODEL 06/FORD TRUCK/ECONO CUTAWAY/VAN E-45		DELIVERY DATE 01/11/07	STOCK NO.
	VEHICLE I.D. NO. 1FDXE45PX6DB18552		SELLING DEALER NO.	DELIVERY MILES
	F.T.E. NO. 23-2371722	P.O. NO.	R.O. DATE 09/29/11	PRODUCTION DATE 09/06/06
RESIDENCE PHONE 215-269-4630	BUSINESS PHONE 215-946-9357 x702	COMMENTS E# 109	MO: 106657	

VEHICLE # **127**
JOB# 1 CHARGES

LABOR
JOB# 1 10FOZDIAGDRV. DRIVEABILITY/DIAG. TECH(S): 2539 1433.13

CUSTOMER STATES COOLANT BLOWING OUT OF EXHAUST VERIFIED CONCERN. PCM SELF TEST. KOEC CODES P0266, P0299, P0478, P1335. MONITOR PIDS, EBP SIGNAL ERRATIC. COOLANT LEVEL LOW. PRESS. TEST DEGAS BOTTLE AND CAP. HOLD. VACUUM TEST COOLING SYSTEM. BLEED DOWN OF 18 PSI IN 10 MIN. R/I INTAKE MANIFOLD TO ACCESS EGR COOLER. TIME TO R/I BUS RADIO. DOOR CONTROLS. FIRE SUPPRESSION HOSES. TEST EGR COOLER OFF ENGINE LEAKING. REPLACED EGR COOLER AND OIL COOLER KIT. REPLACED EBP SENSOR AND CONNECTOR. DISASSEMBLE TURBO. FOUND COKING. WORN UNISON RING. OVERHAULED AND CLEANED TURBO. ASSEMBLE ENGINE AND FLUSH COOLING SYSTEM. ROAD TEST TO CK FOR LEAKING HEAD GASKETS. OK. CHANGED ENGINE OIL AND FILTER.

LABOR 1433.13
JOB# 1 TOTALS
JOB# 1 JOURNAL PREFIX FOCS JOB# 1 TOTAL 1433.13

LABOR
JOB# 2 01FOZ99P. MULTI-POINT. TECH(S): 2539 0:00

MULTI-POINT INSPECTION SPECIAL
Perform Multi-Point Inspection All

LABOR
JOB# 3 04FOZ. TRANSMISSION OPS. TECH(S): 2539 703.95

CUSTOMER STATES THE OD LIGHT IS FLASHING AT TIMES. TCM SELF-TEST, CODE P0713. MONITOR PIDS, TFT READS -40. INTERMITTENT. CK TFT CIRCUITS FOR OPEN OR SHORT, NONE FOUND. CK TFT RESISTANCE, 920 K OHMS. HIGH. R/I PAN. CK INTERNAL WIRING. POOR PIN FIT ON TFT CONNECTOR. R/I SOLENOID BODY. REPLACED INTERNAL HARNESS. TFT SENSOR. REFILLED TRANS. CLEAR CODES AND ROAD TEST. OK. RERUN SELF-TEST. PASS.

PARTS	QTY	FP NUMBER	DESCRIPTION	UNIT PRICE	
	1	4C3Z-7G276-AA	CONNECT	132.39	132.39
	1	BC3Z-7H141-A	SENSOR	20.97	20.97
	1	8C3Z-7G155-A	GASKET	17.17	17.17
	1	3C3Z-7A098-AA	SCREEN	41.32	41.32
	1	3C3Z-7Z276-AA	SEAL	9.14	9.14
	10	XT-6-QSP	FLUID	7.95	79.50
TOTAL - PARTS					300.49

DISCLAIMER OF WARRANTIES
The only warranties, if any, applying to the part(s) and/or service are those offered by the manufacturer. The selling dealer hereby expressly disclaims all warranties, either expressed or implied, including any implied warranties of merchantability or fitness for a particular purpose, and neither assumes nor authorizes any other person to assume for it any liability in connection with the sale of this part(s) and/or service. Buyer shall not be entitled to recover from the selling dealer any consequential damages, damages to property, damages for loss of use, loss of time, loss of profits or income, or any other incidental damages.

IMPORTANT
You may receive a questionnaire from the manufacturer in the next few weeks. If for any reason you cannot grade us completely Satisfied, on each question, please contact your service advisor.
MCCAFFERTY AUTO GROUP
Phone: 215-945-8000
www.mccafferty.com
THANK YOU!

Make your next service appointment on-line at www.mccafferty.com

Reynolds and Reynolds ERAINTIVE C061/228 0 (0606)

BUCKS COUNTY TRANSPORT, INC.

49770
49770
1/4/2012

Payee McCAFFERTY FORD
Vendor ID MCCAFF

Account #:

Invoice	Description	Discount	Amount
CM10188	TRANSMISSION CORE RETURN CREDIT	\$0.00	(\$600.00)
POCS338774	REPLACED EGR COOLER AND OIL COOLER ON BUS #127	\$0.00	\$2,809.77
Total :		\$0.00	\$2,209.77

PRODUCT 2UM102 USE WITH 91500 ENVELOPE

Deluxe For Business 1-800-257-8354

PRINTED IN U.S.A.



#143



Jasper Engines & Transmissions Exchange, Inc.
PO Box 650 - 815 Varnsburg Rd
Jasper, IN 47547 800-827-7455

TERMS: Net 30 Days from Invoice Date
PAST DUE BALANCES are subject to a
FINANCE CHARGE of 1-1/2% per month periodic rate,
which is an ANNUAL PERCENTAGE RATE OF 18%

BILL TO:
BUCKS COUNTY TRANSPORT INC
PO BOX 510
HOLICONG, PA 189280510

SHIP TO:
BUCKS COUNTY TRANSPORT INC
2444 DURHAM RD
BRISTOL, PA 190076902

Inv#: 5044216
Acct#: 14334019

Date: 10/12/2011
Terms: NET 30
Tax#: 23-237-1722
PO#: ED

PH#: 215 946 9357

OUAN STOCK# / PROD#	DESCRIPTION	UNIT PRICE	CORE	SKIDS	TOTAL
1.00 5699350 064872	TORGSHIFT 6.0 2	2,677.00	0.00	0.00	2,677.00
1.00 8C2Z-7A095C	TAG# 513792	116.00	0.00	0.00	116.00

ENTERED
10/18/11

59200-000-000-20

Jerharri Apprvd

Elmer H. Hall BUS#(143)

Shipped By: JET TRANSIT Inq#: 6849920

MERCHANDISE	CORES	SKIDS	TAX	TOTAL	INVOICE
2,793.00	0.00	0.00	0.00	2,793.00	

IMPORTANT: TERMS OF SELLER'S LIMITED WARRANTY
ARE AVAILABLE AT: <http://www.jasperengines.com/warranty.pdf>

PLEASE REMIT TO: P.O. BOX 650 - JASPER, IN 47547-0650



JASPER ENGINE & TRANSMISSION EXCHANGE, INC
PO BOX 650
JASPER IN 47547-0650
ADDRESS SERVICE REQUESTED

POSTED
OCT 19 2011

BUCKS COUNTY TRANSPORT INC
PO BOX 510
HOLICONG, PA 189280510

BUCKS COUNTY TRANSPORT, INC.

49283

Payee JASPER ENGINE & TRANSMISSION
Vendor ID: JASPER

Account #: 14834019

49283
11/21/2011

Invoice	Description	Discount	Amount
5005243	TRNAMISSIION WARRANTY CASE FOR BUS #116	\$0.00	\$4,436.00
5015759	WARRANTY CREDIT CASE FOR TRANS FOR BUS #116	\$0.00	(\$4,843.50)
5044216	TRANSMISSION FOR BUS #143	\$0.00	\$2,793.00
Total:		\$0.00	\$2,385.50

PRODUCT DLM102 USE WITH 91500 ENVELOPE

Deluxe For Business 1-800-257-8354

PRINTED IN U.S.A.



#120



Jasper Engines & Transmissions Exchange, Inc.
PO Box 650 - R15 Wernsing Rd.
Jasper, IN 47547 800-827-7455

TERMS: Net 30 Days from Invoice Date
PAST DUE BALANCES are subject to a
FINANCE CHARGE of 1-1/2% per month periodic rate,
which is an ANNUAL PERCENTAGE RATE OF 18%

BILL TO:
BUCKS COUNTY TRANSPORT INC
PO BOX 510
HOLICONG, PA 189280510

SHIP TO:
BUCKS COUNTY TRANSPORT INC
2444 DURHAM RD
BRISTOL, PA 190076902

Inv#: 5153908
Acct#: 14334019

Date: 01/25/2012
Terms: NET 30
Tax#: 23-237-1722
PO#:

PH#: 215 946 9357

QUAN	STOCK# / PROD#	DESCRIPTION	UNIT PRICE	CORE	SKIDS	TOTAL
1.00	5699740 099130	TORQSHIFT 6.0 2	2,582.00	0.00	0.00	2,582.00

ENTERED
1/25/12

59200-000-000-40

Jerhami Apprvd

Shipped By: JET TRANSIT

Inv#: 7011917

MERCHANDISE	CORES	SKIDS	TAX	TOTAL	INVOICE
2,582.00	0.00	0.00	0.00	2,582.00	(Bus #120)

IMPORTANT: TERMS OF SELLER'S LIMITED WARRANTY
ARE AVAILABLE AT: <http://www.jasperengines.com/warranty.pdf>

PLEASE REMIT TO: P.O. BOX 650 • JASPER, IN 47547-0650



JASPER ENGINE & TRANSMISSION EXCHANGE, INC
PO BOX 650
JASPER IN 47547-0650
ADDRESS SERVICE REQUESTED

POSTED
FEB 1 ENT'D

BUCKS COUNTY TRANSPORT INC
PO BOX 510
HOLICONG, PA 189280510

BUCKS COUNTY TRANSPORT, INC.
Payee JASPER ENGINE & TRANSMISSION
Vendor ID JASPER

Account #: 14334019

50728
50728
2/28/2012

Invoice	Description	Discount	Amount
5147034	TRANSMISSION FOR BUS #115	\$0.00	\$2,582.00
5149163	TRANSMISSION FOR BUS #111	\$0.00	\$2,128.00
5153908	TRANSMISSION FOR BUS #120	\$0.00	\$2,582.00
Total :		\$0.00	\$7,292.00

PRODUCT DLM102 USE WITH 91500 ENVELOPE

Deluxe For Business 1-800-257-8354

PRINTED IN U.S.A.



119



Jasper Engines & Transmissions Exchange, Inc.
PO Box 650 - 815 W. Wrasling Rd.
Jasper, IN 47547 800.827.7455

TERMS: Net 30 Days from Invoice Date
PAST DUE BALANCES are subject to a
FINANCE CHARGE of 1-1/2% per month periodic rate,
which is an ANNUAL PERCENTAGE RATE OF 18%

Inv#: 5234536
Acct#: 14334019

BILL TO:
BUCKS COUNTY TRANSPORT INC
PO BOX 510
HOLICONG, PA 189280510

SHIP TO:
BUCKS COUNTY TRANSPORT INC
2444 DURHAM RD
BRISTOL, PA 190076902

Date: 04/11/2012
Terms: NET 30
Tax#: 23-237-1722
PO#:

PH#: 215 948 9357

QUAN	STOCK# / PROD#	DESCRIPTION	UNIT PRICE	CORE	SKIDS	TOTAL
1.00	5699740 104329	TORQSHIFT 6.0 2	2,582.00	0.00	0.00	2,582.00

ENTERED
4/11/12

59200-000-000-20

Jerharri Aprv'd

Edna H. [Signature] (#119)
Shipped By: JET TRANSIT Inq#: 7105628

MERCHANDISE	CORES	SKIDS	TAX	TOTAL	INVOICE
2,582.00	0.00	0.00	0.00	2,582.00	

IMPORTANT: TERMS OF SELLER'S LIMITED WARRANTY
ARE AVAILABLE AT: <http://www.jasperengines.com/warranty.pdf>

PLEASE REMIT TO: P.O. BOX 650, JASPER, IN 47547-0650



JASPER ENGINE & TRANSMISSION EXCHANGE, INC
PO BOX 650
JASPER IN 47547-0650
ADDRESS SERVICE REQUESTED

POSTED
APR 19 ENT'D

BUCKS COUNTY TRANSPORT INC
PO BOX 510
HOLICONG, PA 189280510

BUCKS COUNTY TRANSPORT, INC.

51760

Payee JASPER ENGINE & TRANSMISSION

51760

Vendor ID JASPER

Account #: 14334019

5/15/2012

invoice	Description	Discount	Amount
5234536	TRANSMISSION FOR BUS #119	\$0.00	\$2,582.00
Total :		\$0.00	\$2,582.00

PRODUCT DLM102

USE WITH 91500 ENVELOPE

Deluxe For Business 1-800-257-8354

PRINTED IN U.S.A.

A



#118



Jasper Engines & Transmissions Exchange, Inc.
PO Box. 650 - 815 Wernsing Rd.
Jasper, IN 47547 800-827-7455

TERMS: Net 30 Days from Invoice Date
PAST DUE BALANCES are subject to a
FINANCE CHARGE of 1-1/2% per month periodic rate,
which is an ANNUAL PERCENTAGE RATE OF 18%

BILL TO:
BUCKS COUNTY TRANSPORT INC
PO BOX 510
HOLICONG, PA 189280510

SHIP TO:
BUCKS COUNTY TRANSPORT INC
2444 DURHAM RD
BRISTOL, PA 190076902

Inv#: 5240982
Acct#: 14334019
Date: 04/18/2012
Terms: NET 30
Tax#: 23-237-1722
PO#: ED

PH#: 215 946 9357

QUAN	STOCK# / PROD#	DESCRIPTION	UNIT PRICE	CORE	SKIDS	TOTAL
1.00	5699740 103061	TORQSHIFT 6.0 2	2,582.00	0.00	0.00	2,582.00

ENTERED
5/1/12

59200-000-000-20

Jerharrl Apprvd

Shipped By: JET TRANSIT Inq#: 7245418

Edward Herb... (#118)

MERCHANDISE	CORES	SKIDS	TAX	TOTAL	INVOICE
2,582.00	0.00	0.00	0.00	2,582.00	

IMPORTANT: TERMS OF SELLER'S LIMITED WARRANTY
ARE AVAILABLE AT: <http://www.jasperengines.com/warranty.pdf>

PLEASE REMIT TO: P.O. BOX 650 • JASPER, IN 47547-0650



JASPER ENGINE & TRANSMISSION EXCHANGE, INC.
PO BOX 650
JASPER IN 47547-0650
ADDRESS SERVICE REQUESTED

POSTED
MAY 2 ENTD

BUCKS COUNTY TRANSPORT INC
PO BOX 510
HOLICONG, PA 189280510

BUCKS COUNTY TRANSPORT, INC.

Payee JASPER ENGINE & TRANSMISSION
Vendor ID JASPER

Account #: 14334019

51973
51973
5/30/2012

Invoice	Description	Discount	Amount
5240982	TRANSMISSION FOR BUS #118	\$0.00	\$2,582.00

Total : \$0.00 \$2,582.00

PRODUCT DLM102 USE WITH 91500 ENVELOPE

Deluxe For Business 1-800-257-8354

PRINTED IN U.S.A.



#115



Jasper Engines & Transmissions Exchange, Inc.
PO Box 650 - 815 Warrasing Rd.
Jasper, IN 47547 800.627.7455

TERMS: Net 30 Days from Invoice Date
PAST DUE BALANCES are subject to a
FINANCE CHARGE of 1-1/2% per month periodic rate,
which is an ANNUAL PERCENTAGE RATE OF 18%

BILL TO:
BUCKS COUNTY TRANSPORT INC
PO BOX 510
HOLICONG, PA 189280510

SHIP TO:
BUCKS COUNTY TRANSPORT INC
2444 DURHAM RD
BRISTOL, PA 190076902

Inv#: 5147034
Acct#: 14334019

Date: 01/18/2012
Terms: NET 30
Tax#: 23-237-1722
PO#: ED

PH#: 215 946 9357

QUAN	STOCK# / PROD#	DESCRIPTION	UNIT PRICE	CORE	SKIDS	TOTAL
1.00	5699740 108161	TORQSHIFT 6.0 2	2,582.00	0.00	0.00	2,582.00

ENTERED
1/24/12

59200-000-000-94

Edmund Heckel Bos #115

Shipped By: JET TRANSIT

Inq#: 7000253

MERCHANDISE	CORES	SKIDS	TAX	TOTAL	INVOICE
2,582.00	0.00	0.00	0.00	2,582.00	

IMPORTANT: TERMS OF SELLER'S LIMITED WARRANTY
ARE AVAILABLE AT: <http://www.jasperengines.com/warranty.pdf>

PLEASE REMIT TO: P.O. BOX 650 • JASPER, IN 47547-0650



JASPER ENGINE & TRANSMISSION EXCHANGE, INC
PO BOX 650
JASPER IN 47547-0650
ADDRESS SERVICE REQUESTED

POSTED
JAN 25 2012

BUCKS COUNTY TRANSPORT INC
PO BOX 510
HOLICONG, PA 189280510

BUCKS COUNTY TRANSPORT, INC.
Payee JASPER ENGINE & TRANSMISSION
Vendor ID JASPER

Account #: 14334019

50728
50728
2/28/2012

Invoice	Description	Discount	Amount
5147034	TRANSMISSION FOR BUS #115	\$0.00	\$2,582.00
5149163	TRANSMISSION FOR BUS #111	\$0.00	\$2,128.00
5153908	TRANSMISSION FOR BUS #120	\$0.00	\$2,582.00
Total :		\$0.00	\$7,292.00

PRODUCT DLM102 USE WITH 91500 ENVELOPE

Deluxe For Business 1-800-257-8354

PRINTED IN U.S.A.



III

#122



Jasper Engines & Transmissions Exchange, Inc.
PO Box 650 - B15 Warrasing Rd.
Jasper, IN 47547 800.827.7455,

TERMS: Net 30 Days from Invoice Date
PAST DUE BALANCES are subject to a
FINANCE CHARGE of 1-1/2% per month periodic rate,
which is an ANNUAL PERCENTAGE RATE OF 18%

BILL TO:
BUCKS COUNTY TRANSPORT INC
PO BOX 510
HOLICONG, PA 189280510

SHIP TO:
BUCKS COUNTY TRANSPORT INC
2444 DURHAM RD
BRISTOL, PA 190076902

Inv#: 5549843
Acct#: 14334019

Date: 06/11/2012
Terms: NET 30
Tax#: 23-237-1722
PO#:

PH#: 215 946 9357

QUAN	STOCK# / PROD#	DESCRIPTION	UNIT PRICE	CORE	SKIDS	TOTAL
1.00	5699740 189072	TORQSHIFT 6.0 2	2,423.00	0.00	0.00	2,423.00

ENTERED
6/19/12

59200-000-000-94

POSTED
JUN 25 ENT

Shipped By: JET TRANSIT

Inq#: 7325107

MERCHANDISE	CORES	SKIDS	TAX	TOTAL	INVOICE
2,423.00	0.00	0.00	0.00	2,423.00	

IMPORTANT: TERMS OF SELLER'S LIMITED WARRANTY
ARE AVAILABLE AT: <http://www.jasperengines.com/warranty.pdf>

PLEASE REMIT TO: PO BOX 650 JASPER, IN 47547-0650



JASPER ENGINE & TRANSMISSION EXCHANGE, INC
PO BOX 650
JASPER IN 47547-0650
ADDRESS SERVICE REQUESTED

BUCKS COUNTY TRANSPORT INC
PO BOX 510
HOLICONG, PA 189280510

BUCKS COUNTY TRANSPORT, INC.

52446

Payee JASPER ENGINE & TRANSMISSION

52446

Vendor ID JASPER

Account #: 14334019

7/16/2012

Invoice	Description	Discount	Amount
5549843	TRANSMISSION FOR BUS #122	\$0.00	\$2,423.00
Total :		\$0.00	\$2,423.00

PRODUCT DLM102 USE WITH 91500 ENVELOPE

Deluxe For Business 1-800-257-8354

PRINTED IN U.S.A.





PARTS INVOICE

CELL: 267-446-7430

CUST NO.	TAX EXEMPT NUMBER	CUST. P. O. NO.	SHIP VIA	PAY	SOLD BY	INVOICE DATE	INVOICE NO.
8086	23-2371722	07-FREESTAR		CHARGE	DAVID FREAS	03/21/12	18378
215-946-9357						FOW X	
B I L L 8702 edhackett@bcctransport.org BUCKS COUNTY TRANSPORT 2444 DURHAM RD BRISTOL, PA 19007-6902				S H I P 2FMZA51667BA06192 117,738 SER # R1166345			

SHIP QTY	B.O. QTY	PART NUMBER / DESCRIPTION	BIN	LIST	NET	AMOUNT
1	0	5F2Z-7000-BRM AUTOMAT CORE PRICE	SPORD	2169.33	1789.70 .600.00	1789.70 600.00
SUBTOTAL						2389.70
TAX						0.00
FREIGHT						0.00
PAY THIS AMOUNT						2389.70

Any warranties on the product sold hereby are those made by the manufacturer. The seller hereby expressly disclaims all warranties, either express or implied, including any implied warranty of merchantability or fitness for a particular purpose, and the seller neither assumes nor authorizes any other person to assume for it any liability in connection with the sale of said products.

ENTERED 3/27/12
POSTED MAR 28 2012
51200 000 000 60

Edward Hackett

THANK YOU VERY MUCH FOR YOUR BUSINESS!!!!
PARTS MUST BE IN ORIGINAL PACKAGING AND IN RESALABLE CONDITION ON ALL RETURNS.
POSITIVELY NO EXCHANGES OR REFUNDS WITHOUT THIS TICKET. NO REFUNDS ON SPECIAL ORDER. NO REFUNDS AFTER 10 DAYS. 20% HANDLING CHARGE ON ALL RETURNS. NO RETURNS ON ELECTRICAL PARTS. REFUND ON PURCHASES PAID BY CHECK ARE REFUNDED AFTER CHECK CLEARS.

CUSTOMER COPY



12:40:06 PAGE 1 OF 1 NET572

CUSTOMER COPY



PARTS INVOICE

CELL: 267-446-7430

CUST NO.	TAX EXEMPT NUMBER	CUST. P. O. NO.	SHIP VIA	PAY	SOLD BY	INVOICE DATE	INVOICE NO.
8086	23-2371722	YBC60103		CHARGE	JOHANNA MARTIN	10/18/11	10188
215-946-9357							FOW
X702							X
edhackett@bcctransport.org							
BUCKS COUNTY TRANSPORT							
2444 DURHAM RD							
BRISTOL, PA 19007-6902							
				SHIP MILES 277,909			
				R5219924			

SHIP QTY.	B. O. QTY.	PART NUMBER / DESCRIPTION	BIN	LIST	NET	AMOUNT
1	0	YF2Z-7V000-BRM TRANSMI CORE PRICE	SPORD	2042.67	1777.12	1777.12
					600.00	600.00
SUBTOTAL						2377.12
TAX						0.00
FREIGHT						0.00
PAY THIS AMOUNT						2377.12

Any warranties on the product sold hereby are those made by the manufacturer. The seller hereby expressly disclaims all warranties, either express or implied, including any implied warranty of merchantability or fitness for a particular purpose, and the seller neither assumes nor authorizes any other person to assume for it any liability in connection with the sale of said products.

THANK YOU VERY MUCH FOR YOUR BUSINESS!!!!!!!
PARTS MUST BE IN ORIGINAL PACKAGING AND IN RESALABLE CONDITION ON ALL RETURNS.

POSITIVELY NO EXCHANGES OR REFUNDS WITHOUT THIS TICKET. NO REFUNDS ON SPECIAL ORDER. NO REFUNDS AFTER 10 DAYS. 20% HANDLING CHARGE ON ALL RETURNS. NO RETURNS ON ELECTRICAL PARTS. REFUND ON PURCHASES PAID BY CHECK ARE REFUNDED AFTER CHECK CLEARS.

CUSTOMER COPY

ENTERED
OCT 26



1939 East Lincoln Highway, Langhorne, PA 19047 215-945-8000 www.mccafferty.com

11:56:53 PAGE 1 OF 1 NET572

CUSTOMER COPY

BUCKS COUNTY TRANSPORT, INC.

49287

Payee McCAFFERTY FORD

49287

Vendor ID MCCAFF

Account #:

11/21/2011

Invoice	Description	Discount	Amount
10004	SWITCH; CONNECTORS	\$0.00	\$54.44
10132	CONTROL	\$0.00	\$203.73
10159	BUSHINGS	\$0.00	\$11.56
10188	TRANSMISSION	\$0.00	\$2,377.12
9555	PIPE ASSEMBLY	\$0.00	\$41.13
9653	TUBE; INDICATOR	\$0.00	\$45.39
9696	TUBE	\$0.00	\$33.98
9760	TUBE	\$0.00	\$40.18
9890	CLEANER	\$0.00	\$290.83
9910	SENSOR	\$0.00	\$74.66
CM9159	CORE RETURN CREDIT	\$0.00	(\$100.00)
CM9432	MODULE CORE RETURN CREDIT	\$0.00	(\$140.00)
FOCS334876	REPLACED SENSOR AND REPAIRED OVERDRIVE LIGHT...	\$0.00	\$446.41

Invoice listing continues on next page.

PRODUCT DLM102 USE WITH 91500 ENVELOPE

Deluxe For Business 1-800-257-8354

PRINTED IN U.S.A.

A



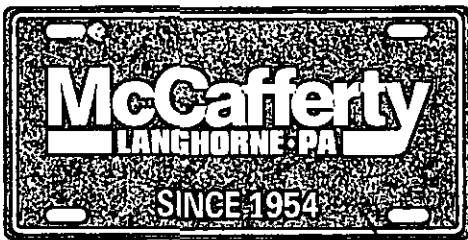

1939 East Lincoln Highway, Langhorne, PA 19047 215-945-8000 www.mccafferty.com

CELL: 267-446-7430

Bus # 115

CUSTOMER NO. 8086	ADVISOR DARRIN ALBERTO	TAG NO. 4541	INVOICE DATE 05/17/12	INVOICE NO. FOCS377523
BUCKS COUNTY TRANSPORT 2444 DURHAM RD BRISTOL, PA 19007-6902	LABOR RATE	LICENSE NO. BA56573	MILEAGE 143,717	COLOR WHITE
edhackett@bctransport.org	YEAR / MAKE / MODEL 05/FORD TRUCK/EGONO CUTAWAY/VAN E#45	DELIVERY DATE 03/02/05	DELIVERY MILES	DELIVERY DATE 03/02/05
RESIDENCE PHONE 215-269-4630	VEHICLE I.D. NO. 1FDXE45P45HA23945	SELLING DEALER NO. FMC	PRODUCTION DATE 09/24/04	
BUSINESS PHONE 215-946-9357 x702	F.T.E. NO. 23-237,172	P.O. NO.	R.O. DATE 05/02/12	
	COMMENTS E# 06			MO: 143717

VEHICLE # [] #115
JOB# 1 CHARGES

LABOR
J# 1 10FOZDIAGDRV DRIVEABILITY DIAG TECH(S): 2512 1665.95
CUST STATES CRANK NO START
DIAGNOSE NO START HAS CODES F0E CAM SENSOR SENSOR IS NEW
REPLACE MAIN ENGINE WIRE HARNESS

PARTS	QTY	FP NUMBER	DESCRIPTION	UNIT PRICE	PRICE
	1	H75	H75 KEY	1.18	1.18
	1	5C2Z-12B637-SA	WIRE AS	935.20	935.20
	1	4C2Z-6763-AA	PIPE AS	106.70	106.70
	1	3C3Z-10884-AA	SENDER	35.15	35.15
TOTAL - PARTS					1078.23

MISC	CODE	DESCRIPTION	CONTROL NO	PRICE
	500	FLEET DISCOUNT 15%		249.89
	501	FLEET DISC PARTS		161.73
TOTAL - MISC				411.62

JOB# 1 TOTALS
LABOR 1665.95
PARTS 1078.23
MISC 411.62
JOB# 1 JOURNAL PREFIX FOCS JOB# 1 TOTAL 2332.56

JOB# 2 CHARGES

LABOR
J# 2 01FOZ99P MULTI POINT TECH(S): 2512 0.00
MULTI-POINT INSPECTION SPECIAL
Perform Multi-Point Inspection All

JOB# 2 TOTALS
LABOR 0.00
PARTS 0.00
MISC 0.00
JOB# 2 JOURNAL PREFIX FOCS JOB# 2 TOTAL 0.00

DISCLAIMER OF WARRANTIES
The only warranties, if any, applying to the part(s) and/or service are those offered by the manufacturer. The selling dealer hereby expressly disclaims all warranties, either expressed or implied, including any implied warranties of merchantability or fitness for a particular purpose, and neither assumes nor authorizes any other person to assume for it any liability in connection with the sale of this part(s) and/or service. Buyer shall not be entitled to recover from the selling dealer any consequential damages, damages to property, damages for loss of use, loss of time, loss of profits or income, or any other incidental damages.

IMPORTANT
You may receive a questionnaire from the manufacturer in the next few weeks. If for any reason you cannot grade us "Completely Satisfied" on each question please contact your service advisor.
MCCAFFERTY/AUTO GROUP
Phone: 215-945-8000
www.mccafferty.com
THANK YOU!!

Reynolds and Reynolds, ERAINTIVE, CCAS7298 O (09/09)

Bus # 115

EAJ

Make your next service appointment on-line at www.mccafferty.com



1939 East Lincoln Highway, Langhorne, PA 19047 215-945-8000 www.mccafferty.com

CELL: 267-446-7430

CUSTOMER NO. 8086	ADVISOR DARRIN ALIBERTO	TAG NO. 2408 4541	INVOICE DATE 05/17/12	INVOICE NO. FOCS377523
BUGKS COUNTY TRANSPORT 2444 DURHAM RD BRISTOL, PA 19007-6902 edhackett@bctransport.org	LABOR RATE	LICENSE NO. BA56573	MILEAGE 143,717	COLOR WHITE
	YEAR / MAKE / MODEL 05/FORD TRUCK/ECONO CUTAWAY/VAN E=45	VEHICLE I.D. NO. 1FDXE45P45HA23945	DELIVERY DATE 03/02/05	DELIVERY MILES
	F.T.E. NO. 23-2371722	P.O. NO.	SELLING DEALER NO. FMC	PRODUCTION DATE 09/24/04
	RESIDENCE PHONE 215-269-4630	BUSINESS PHONE 215-946-9357 x702	COMMENTS E# 06	R.O. DATE 05/02/12

TOTALS

 CASH CHECK CK NO. []
 VISA MASTERCARD DISCOVER
 AMER XPRESS OTHER CHARGE

THANK YOU FOR YOUR BUSINESS!!

Edmund Hackett
 CUSTOMER SIGNATURE Bus # (115)

TOTAL LABOR 1665.95
 TOTAL PARTS 1078.23
 TOTAL SUBLET 0.00
 TOTAL G.O.G. 0.00
 TOTAL MISC CHG. 0.00
 TOTAL MISC DISC 411.62
 TOTAL TAX 0.00

TOTAL INVOICE \$ 2332.56

DISCLAIMER OF WARRANTIES

The only warranties, if any, applying to the part(s) and/or service are those offered by the manufacturer. The selling dealer hereby expressly disclaims all warranties, either expressed or implied, including any implied warranties of merchantability or fitness for a particular purpose, and neither assumes nor authorizes any other person to assume for it any liability in connection with the sale of this part(s) and/or service. Buyer shall not be entitled to recover from the selling dealer any consequential damages, damages to property, damages for loss of use, loss of time, loss of profits or income, or any other incidental damages.

ENTERED
 5/22/12

59200-000-000-94



Make your next service appointment on-line at www.mccafferty.com

BUCKS COUNTY TRANSPORT, INC.

52189

Payee McCAFFERTY FORD

52189

Vendor ID MCCAFF

Account #:

6/18/2012

Invoice	Description	Discount	Amount
21277	TUBE ASSEMBLIES	\$0.00	\$221.53
21411	SHROUDS	\$0.00	\$292.60
21452	TRANS COOLER; GASKETS; O RINGS	\$0.00	\$536.79
FOCS377523	REPAIRED ENGINE ON BUS #115	\$0.00	\$2,332.56
Total :		\$0.00	\$3,383.48





1939 East Lincoln Highway, Langhorne, PA 19047 215-945-8000 www.mccafferty.com

CELL: 267-446-7430

CUSTOMER NO. 8086	ADVISOR DARRIN ALIBERTO	2408	TAG NO. 4807	INVOICE DATE 02/06/12	INVOICE NO. F0CS360534
BUCKS COUNTY TRANSPORT 2444 DURHAM RD BRISTOL, PA 19007-6902 edhackett@bctransport.org	LABOR RATE	LICENSE NO. BA59536	MILEAGE 92,900	COLOR WHITE/	STOCK NO.
	YEAR / MAKE / MODEL 06/FORD TRUCK/ECONO CUTAWAY/VAN E-45	DELIVERY DATE 01/18/07		DELIVERY MILES	
	VEHICLE I.D. NO. 1 F D X E 4 5 P 1 6 D B 1 8 5 5 3	SELLING DEALER NO.		PRODUCTION DATE 09/06/06	
	F.T.E. NO. 23-2371722	P.O. NO.	R.O. DATE 01/31/12		
RESIDENCE PHONE 215-269-4630	BUSINESS PHONE 215-946-9357 x702	COMMENTS			MO: 93000

TOTALS

[] CASH [] CHECK CK NO. [] *
 [] VISA [] MASTERCARD [] DISCOVER *
 [] AMER XPRESS [] OTHER [] CHARGE *

TOTAL LABOR....	1876.88
TOTAL PARTS....	850.37
TOTAL SUBLET...	0.00
TOTAL G.O.G....	0.00
TOTAL MISC CHG.	9.95
TOTAL MISC DISC	-409.09
TOTAL TAX.....	0.00
TOTAL INVOICE \$	2328.11

DISCLAIMER OF WARRANTIES

The only warranties, if any, applying to the part(s) and/or service are those offered by the manufacturer. The selling dealer hereby expressly disclaims all warranties, either expressed or implied, including any implied warranties of merchantability or fitness for a particular purpose, and neither assumes nor authorizes any other person to assume for it any liability in connection with the sale of this part(s) and/or service. Buyer shall not be entitled to recover from the selling dealer any consequential damages, damages to property, damages for loss of use, loss of time, loss of profits or income, or any other incidental damages.

THANK YOU FOR YOUR BUSINESS!!

Eduard Hackett Bus (128)
 CUSTOMER SIGNATURE

ENTERED
 2/7/12
 59200-000-000-



POSTED
 FEB 9 2012

Make your next service appointment on-line at www.mccafferty.com



1939 East Lincoln Highway, Langhorne, PA 19047 215-945-8000 www.mccafferty.com

CELL: 267-446-7430

CUSTOMER NO. 8086	ADVISOR DARRIN ALIBERTO	TAG NO. 2408	INVOICE DATE 02/06/12	INVOICE NO. FOCS360534
BUCKS COUNTY TRANSPORT 2444 DURHAM RD BRISTOL, PA 19007-6902	LABOR RATE	LICENSE NO. BA59536	MILEAGE 92,900	COLOR WHITE
edhackett@bctransport.org	YEAR / MAKE / MODEL 06/FORD TRUCK/ECONO CUTAWAY/VAN E=45	VEHICLE I.D. NO. 1FDXE45P16DB18553	DELIVERY DATE 01/18/07	STOCK NO.
RESIDENCE PHONE 215-269-4630	BUSINESS PHONE 215-946-9357 x702	R.T.E. NO. 23-2371722	SELLING DEALER NO.	DELIVERY MILES
COMMENTS	P.O. NO.	R.O. DATE 01/31/12	PRODUCTION DATE 09/06/06	MO: 93000

VEHICLE #] #128
JOB# 1 CHARGES

LABOR
#110FOZDIAGDRV DRIVEABILITY DIAG TECH(S): 2539 1876.88
CUST STATES NO START
DIAG AND REPLACE FUEL REG SNAP RING FITTING AND EGR VALVE

PARTS	QTY	FP	NUMBER	DESCRIPTION	UNIT PRICE	PRICE
	2		VC-7-B	ANTI-FR	14.00	28.00
	1		4C3Z-9B246-F	KIT	84.18	84.18
	1		-W302725	HARDWAR	9.56	9.56
	1		6C3Z-9T515-A	TUBE AS	49.82	49.82
	1		5C3Z-9F452-AA	VALVE A	253.85	253.85
	4		-W300012	O RING	9.29	37.16
	1		4C2Z-9T517-AA	KIT - P	103.64	103.64
	1		5C3Z-9C968-CA	REGULAT	284.16	284.16
TOTAL - PARTS						850.37

MISC

CODE	DESCRIPTION	CONTROL NO	PRICE
100	HAZ WASTE SHOP SUPPLIES CHARGE		9.95
500	FLEET DISCOUNT 15%		-281.53
501	FLEET DISC PARTS		-127.56
TOTAL - MISC			-399.14

JOB# 1 TOTALS

LABOR	1876.88
PARTS	850.37
MISC	-399.14
JOB# 1 JOURNAL PREFIX FOCS	JOB# 1 TOTAL 2328.11

DISCLAIMER OF WARRANTIES
The only warranties, if any, applying to the part(s) and/or service are those offered by the manufacturer. The selling dealer hereby expressly disclaims all warranties, either expressed or implied, including any implied warranties of merchantability or fitness for a particular purpose, and neither assumes nor authorizes any other person to assume for it any liability in connection with the sale of this part(s) and/or service. Buyer shall not be entitled to recover from the selling dealer any consequential damages, damages to property, damages for loss of use, loss of time, loss of profits or income, or any other incidental damages.

IMPORTANT
You may receive a questionnaire from the manufacturer in the next few weeks. If for any reason you cannot grade us, Completely Satisfied, on each question please contact your service advisor. **McCAFFERTY.AUTO.GROUP**
Phone: 215-945-8000
www.mccafferty.com
THANK YOU!

JOB# 2 CHARGES

LABOR
#1201FOZ99P MULTI-POINT TECH(S): 2539 0.00
MULTI-POINT INSPECTION SPECIAL
Perform Multi-Point Inspection All

JOB# 2 TOTALS

JOB# 2 JOURNAL PREFIX FOCS	JOB# 2 TOTAL 0.00
----------------------------	-------------------

ESTIMATE
CUSTOMER HEREBY ACKNOWLEDGES RECEIVING ORIGINAL ESTIMATE OF \$99.95 (+TAX)

POSTED
FEB 9 2012

Make your next service appointment on-line at www.mccafferty.com

Remolds and Reynolds - EPA/NTNIVE - C6557288 0 (8/09)

Thank You, We Appreciate Your Business!

BUCKS COUNTY TRANSPORT, INC.

Payee McCAFFERTY FORD
Vendor ID MCCAFF

Account #:

51051
51051
3/20/2012

Invoice	Description	Discount	Amount
15438	MASTER CYLINDER	\$0.00	\$180.25
15495-1	INSULATORS; SPACERS	\$0.00	\$65.87
15498	RESEVOIR; CAP	\$0.00	\$67.66
FOCS360534	REPAIRED NO START AND REPLACED EGR VALVE ON B...	\$0.00	\$2,328.11
Total :		\$0.00	\$2,641.89

PRODUCT DLW102 USE WITH 91500 ENVELOPE

Deluxe For Business 1-800-257-8354

PRINTED IN U.S.A.



#133

1939 East Lincoln Highway, Langhorne, PA 19047 215-945-8000 www.mccafferty.com

CELL: 267-446-7430

CUSTOMER NO. 8086	ADVISOR DARRIN ALIBERTO	TAG NO. 2408	4918	INVOICE DATE 07/28/11	INVOICE NO. FOCS326059
BUCKS COUNTY TRANSPORT 2444 DURHAM RD BRISTOL, PA 19007-6902 edhackett@bcctransport.org	LABOR RATE	LICENSE NO.	MILEAGE 123,686	COLOR WHITE/	STOCK NO.
	YEAR / MAKE / MODEL 06/FORD TRUCK/ECONO CUTAWAY/VAN E-45			DELIVERY DATE	DELIVERY MILES
	VEHICLE I.D. NO. 1FDXE45P06DB43783			SELLING DEALER NO.	PRODUCTION DATE
	F.T.E. NO. 23-2371722	P.O. NO.	R.O. DATE 07/21/11		
RESIDENCE PHONE 215-269-4630	BUSINESS PHONE 215-946-9357 x702	COMMENTS			MO: 123686

JOB# 1 CHARGES

LABOR
 #1 03FOZDIAGCHG 22DIAG CHARGING SYS C 45 TECH(S): 2512 2058.32
 CUST. STATES CRANK NO START

PARTS	QTY	FP NUMBER	DESCRIPTION	UNIT PRICE	
	2	W302908	HARDWAR.	26.19	52.38
	1	4C3Z-9B246-F	KIT	84.05	84.05
TOTAL PARTS					136.43

JOB# 1 TOTALS

LABOR 2058.32
 PARTS 136.43

JOB# 1 JOURNAL PREFIX FOCS JOB# 1 TOTAL 2194.75

DISCLAIMER OF WARRANTIES

The only warranties, if any, applying to the part(s) and/or service are those offered by the manufacturer. The selling dealer hereby expressly disclaims all warranties, either expressed or implied, including any implied warranties of merchantability or fitness for a particular purpose, and neither assumes nor authorizes any other person to assume for it any liability in connection with the sale of this part(s) and/or service. Buyer shall not be entitled to recover from the selling dealer any consequential damages, damages to property, damages for loss of use, loss of time, loss of profits or income, or any other incidental damages.

JOB# 2 CHARGES

LABOR
 #2 01FOZ99P 1MULTI-POINT TECH(S): 2512 0.00
 MULTI-POINT INSPECTION SPECIAL
 Perform Multi-Point Inspection All

JOB# 2 TOTALS

JOB# 2 JOURNAL PREFIX FOCS JOB# 2 TOTAL 0.00

ESTIMATE
 CUSTOMER HEREBY ACKNOWLEDGES RECEIVING ORIGINAL ESTIMATE OF \$39.95 (+TAX)

TOTALS

TOTAL LABOR....	2058.32
TOTAL PARTS....	136.43
TOTAL SUBLET...	0.00
TOTAL G.O.G....	0.00
TOTAL MISC CHG....	0.00
TOTAL MISC DISC....	0.00
TOTAL TAX.....	0.00
TOTAL INVOICE \$	2194.75



THANK YOU FOR YOUR BUSINESS!!

Ed Hackett Bas #133
 CUSTOMER SIGNATURE

ENTERED 8/16/11

59200-000-000-94

POST PAID

Make your next service appointment on-line at www.mccafferty.com

Reynolds and Reynolds ERMANTWIVE CC68728 O (06/06)

BUCKS COUNTY TRANSPORT, INC.

48138

Payee McCAFFERTY FORD
Vendor ID MCCAFF

Account #:

48138
9/13/2011

Invoice	Description	Discount	Amount
FOCS324044	ENGINE REPAIR ON BUS #117	\$0.00	\$648.48
FOCS324715	DIAGNOSIS ON BUS #129	\$0.00	\$213.90
FOCS325729	REPLACED RELAY ON BUS #117	\$0.00	\$52.58
FOCS326059	REPAIR WORK COMPLETED ON BUS #133	\$0.00	\$2,194.75
Total :		\$0.00	\$4,743.26



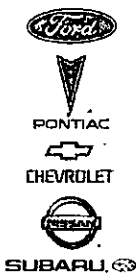

FRED BEANS FORD LINCOLN MERCURY MITSUBISHI

Route 611 & Sawmill Road
 Doylestown, PA 18901
 (215) 348-2900 Fax (215) 348-9435
 www.fredbeans.com

#135



CELL: 267-221-1314

CUSTOMER NO. 21035	ADVISOR JESSE YEARS	1512	TAG NO. 5883	INVOICE DATE 01/17/12	INVOICE NO. FTCS620593
BUCKS COUNTY TRANSPORT 2444 DURHAM RD BRISTOL, PA 19007-6902	LABOR RATE	LICENSE NO. 135	MILEAGE 116,905	COLOR BLUE/WHITE/	STOCK NO.
	YEAR / MAKE / MODEL 06/FORD TRUCK/ECONO COM CTWAY/			DELIVERY DATE	DELIVERY MILES
	VEHICLE I.D. NO. 11F-DX-E450P-9-6-D-B1431717-9			SELLING DEALER NO.	PRODUCTION DATE
	F.T.E. NO. 23237172		P.O. NO.		01/13/12
RESIDENCE PHONE 215-946-9357	BUSINESS PHONE 215-946-9357	COMMENTS		DATE COMPLETED	MILEAGE OUT MO: 116912

CONSISTANT REVIEW OF COMPONENTS BEFORE ANY ADDITIONAL DAMAGE IS INCURRED OR SAFETY IS COMPROMISED. WE APPRECIATE YOU DOING BUSINESS WITH US! THERE ARE NO RECOMMENDATIONS REGARDING YOUR BRAKES AT THIS TIME. THANK YOU!

JOB# 11 TOTALS.....
 JOB# 12 CHARGES.....
 JOB# 11 JOURNAL PREFIX FTCS JOB# 11 TOTAL 0.00

LABOR.....
 #12+04FOZV TIRE CONCERN SOON TECH(S):2250 0.00%
 COMPLETED INSPECTION OF TIRES FOR CONDITION AND TREAD DEPTH CONTINUOUS MONITORING FOR TREAD LIFE - CONCERN NOW MEASURED IN THE "YELLOW" ZONE WHERE REPLACMENT MAY BE NECESSARY DUE TO DAMAGE OR EXCESSIVE WEAR ESTABLISHED. SEE YOUR SERVICE CONSULTANT REGARDING THE CORRECT TIRES FOR YOUR VEHICLE AT A "MEET OR BEAT" PRICE!

JOB# 12 TOTALS.....
 JOB# 12 JOURNAL PREFIX FTCS JOB# 12 TOTAL 0.00

MISC.....CODE.....DESCRIPTION.....CONTROL NO.....
 JOB # A 102 ENVIRONMENTAL HAZ WASTE FEE 9.95
 TOTAL - MISC 9.95

ESTIMATE.....
 CUSTOMER HEREBY ACKNOWLEDGES RECEIVING ORIGINAL ESTIMATE OF \$2135.00 (+TAX)

POSTED
 JAN 23 2012

SURF THE WEB WITH FRED BEANS VISIT US AT www.fredbeans.com
 ALSO SAVE MONEY ON YOUR NEXT VISIT WITH OUR INTERNET COUPONS PLEASE REMEMBER TO RETURN YOUR MANUFACTURERS SURVEY COMPLETE WE APPRECIATE YOUR POSITIVE RESPONSE TO FORD MOTOR COMPANY!

 HOUSE CHARGE [] ACCT#..... *
 CASH [] CHECK [] #..... *
 VISA [] MASTERCARD [] AMEX [] *
 ACCEPTED BY.....DATE..... *

TOTAL INVOICE \$ 2134.88

59200-800-000 40

YOUR STATE INSPECTION
 EXPIRES _____

TIRES _____ BRAKES _____

ANTIFREEZE PROTECTION

YOUR VEHICLE IS PARKED

IN SPOT **JAN 19 ENTD**

RECEIVED
 JAN 18 2012

Chris R. [Signature] **JAN 17 2012 VEH #135**

Fred Beans
 Everything Automotive

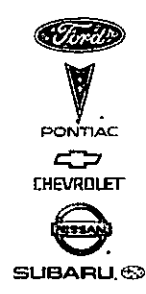

FRED BEANS FORD LINCOLN MERCURY MITSUBISHI
 Route 611 & Sawmill Road
 Doylestown, PA 18901
 (215) 348-2900 Fax (215) 348-9435
 www.fredbeans.com



CELL: 267-221-1314

CUSTOMER NO. 21035	ADVISOR JESSE YEARS	1512	TAG NO. 5883	INVOICE DATE 01/17/12	INVOICE NO. FTCS620593																														
BUCKS COUNTY TRANSPORT 2444 DURHAM RD BRISTOL, PA 19007-6902	LABOR RATE	LICENSE NO. 135	MILEAGE 116,905	COLOR BLUE/WHITE/	STOCK NO.																														
	YEAR / MAKE / MODEL	06/FORD TRUCK/ECONO COM CTWAY/			DELIVERY DATE	DELIVERY MILES																													
	VEHICLE I.D. NO.	1FEDXAE145P906D3B43779			SELLING DEALER NO.	PRODUCTION DATE																													
	F.T.E. NO. 23237172	P.O. NO.	01/13/12																																
RESIDENCE PHONE 215-946-9357	BUSINESS PHONE 215-946-9357	COMMENTS		DATE COMPLETED	MILEAGE OUT MO: 116912																														
<table border="1"> <thead> <tr> <th>PARTS</th> <th>QTY</th> <th>FP NUMBER</th> <th>DESCRIPTION</th> <th>UNIT PRICE</th> <th></th> </tr> </thead> <tbody> <tr> <td></td> <td>2</td> <td>8C2Z-3050-A</td> <td>JOINT ASY - BA</td> <td>44.91</td> <td>89.82</td> </tr> <tr> <td></td> <td>8</td> <td>NPN</td> <td>HARDWARE</td> <td>2.50</td> <td>20.00</td> </tr> <tr> <td></td> <td>2</td> <td>8C3Z-3049-B</td> <td>JOINT ASY - BA</td> <td>72.27</td> <td>144.54</td> </tr> <tr> <td colspan="4"></td> <td>TOTAL - PARTS</td> <td>254.36</td> </tr> </tbody> </table>				PARTS	QTY	FP NUMBER	DESCRIPTION	UNIT PRICE			2	8C2Z-3050-A	JOINT ASY - BA	44.91	89.82		8	NPN	HARDWARE	2.50	20.00		2	8C3Z-3049-B	JOINT ASY - BA	72.27	144.54					TOTAL - PARTS	254.36	YOUR STATE INSPECTION EXPIRES _____ TIRES _____ BRAKES _____ + + ANTIFREEZE PROTECTION	
PARTS	QTY	FP NUMBER	DESCRIPTION	UNIT PRICE																															
	2	8C2Z-3050-A	JOINT ASY - BA	44.91	89.82																														
	8	NPN	HARDWARE	2.50	20.00																														
	2	8C3Z-3049-B	JOINT ASY - BA	72.27	144.54																														
				TOTAL - PARTS	254.36																														
<table border="1"> <thead> <tr> <th>MISC</th> <th>CODE</th> <th>DESCRIPTION</th> <th>CONTROL NO</th> <th></th> </tr> </thead> <tbody> <tr> <td></td> <td>410</td> <td>FLEET CUSTOMER DISC - 20% SVC</td> <td></td> <td>-64.39</td> </tr> <tr> <td></td> <td>411</td> <td>FLEET CUSTOMER DISC - 20% PTS</td> <td></td> <td>-50.87</td> </tr> <tr> <td colspan="4"></td> <td>TOTAL - MISC</td> <td>-115.26</td> </tr> </tbody> </table>				MISC	CODE	DESCRIPTION	CONTROL NO			410	FLEET CUSTOMER DISC - 20% SVC		-64.39		411	FLEET CUSTOMER DISC - 20% PTS		-50.87					TOTAL - MISC	-115.26											
MISC	CODE	DESCRIPTION	CONTROL NO																																
	410	FLEET CUSTOMER DISC - 20% SVC		-64.39																															
	411	FLEET CUSTOMER DISC - 20% PTS		-50.87																															
				TOTAL - MISC	-115.26																														
JOB# 8 TOTALS LABOR 321.95 PARTS 254.36 MISC -115.26 JOB# 8 JOURNAL PREFIX FTCS JOB# 8 TOTAL 461.05																																			
JOB# 9 CHARGES LABOR #9+12FOZTRUCK ALIGN TRUCK TECH(S):352 89:95 PERFORM COMPUTERIZED WHEEL ALIGNMENT F-SERIES. E-SERIES TRUCK PERFORM COMPUTERIZED WHEEL ALIGNMENT E-SERIES TRUCK. ROAD TEST, DRIFTED TO RIGHT. ROTATE FRONT TIRES SIDE TO SIDE STAYS STRAIGHT.				YOUR VEHICLE IS PARKED IN SPOT # _____																															
<table border="1"> <thead> <tr> <th>MISC</th> <th>CODE</th> <th>DESCRIPTION</th> <th>CONTROL NO</th> <th></th> </tr> </thead> <tbody> <tr> <td></td> <td>410</td> <td>FLEET CUSTOMER DISC - 20% SVC</td> <td></td> <td>-17.99</td> </tr> <tr> <td colspan="4"></td> <td>TOTAL - MISC</td> <td>-17.99</td> </tr> </tbody> </table>				MISC	CODE	DESCRIPTION	CONTROL NO			410	FLEET CUSTOMER DISC - 20% SVC		-17.99					TOTAL - MISC	-17.99																
MISC	CODE	DESCRIPTION	CONTROL NO																																
	410	FLEET CUSTOMER DISC - 20% SVC		-17.99																															
				TOTAL - MISC	-17.99																														
JOB# 9 TOTALS LABOR 89.95 MISC -17.99 JOB# 9 JOURNAL PREFIX FTCS JOB# 9 TOTAL 71.96																																			
JOB# 10 CHARGES LABOR #10+36FOZBATT BATTERY CONDITION TECH(S):2250 0:00 COMPLIMENTARY BATTERY INSPECTION FOR CONDITION THE STATE OF CHARGE RECOMMENDED TO CONSISTANTLY MONITOR BATTERY CONDITION HAVE YOUR BATTERY CHECKED AT EVERY VISIT!																																			
JOB# 10 TOTALS JOB# 10 JOURNAL PREFIX FTCS JOB# 10 TOTAL 0.00																																			
JOB# 11 CHARGES LABOR #11+05FOZGBK BRAKE CONDITION TECH(S):2250 0:00 COMPLIMENTARY BRAKE PAD AND/OR LINING CONDITION REPORTED IN THE "GREEN" ZONE. Everything Automotive																																			

The Reynolds and Reynolds Company EBANKTIME CC612137 O 05/10

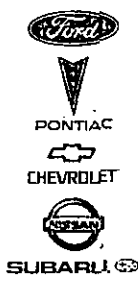

FRED BEANS FORD LINCOLN MERCURY MITSUBISHI

Route 611 & Sawmill Road
 Doylestown, PA 18901
 (215) 348-2900 Fax (215) 348-9435
 www.fredbeans.com



CELL: 267-221-1314

CUSTOMER NO. 21035	ADVISOR JESSE YEARS	1512	TAG NO. 5883	INVOICE DATE 01/17/12	INVOICE NO. FTCS620593																				
BUCKS COUNTY TRANSPORT 2444 DURHAM RD BRISTOL, PA 19007-6902	LABOR RATE	LICENSE NO. 135	MILEAGE 116,905	COLOR BLUE/WHITE/	STOCK NO.																				
	YEAR / MAKE / MODEL 06/FORD TRUCK/ECONO COM CTWAY/			DELIVERY DATE	DELIVERY MILES																				
	VEHICLE I.D. NO. 1F D X E P 4 5 P 9 X 6 D B 4 3 7 7 9			SELLING DEALER NO.	PRODUCTION DATE																				
	F.T.E. NO. 23237172		P.O. NO.		01/13/12																				
RESIDENCE PHONE 215-946-9357	BUSINESS PHONE 215-946-9357	COMMENTS		DATE COMPLETED	MILEAGE OUT. MO: 116912																				
LABOR #16-05F0ZROTORS REPLACE ROTORS TECH(S): 2250 89.95 REPLACE BOTH FRONT ROTORS LEFT ROTOR DAMAGED FRONT, TOO THIN TOO CUT REPLACED ROTORS IN PAIRS. FRONT				YOUR STATE INSPECTION EXPIRES _____ TIRES BRAKES + +																					
PARTS <table border="1"> <thead> <tr> <th>QTY</th> <th>FP-NUMBER</th> <th>DESCRIPTION</th> <th>UNIT PRICE</th> <th>PRICE</th> </tr> </thead> <tbody> <tr> <td>2</td> <td>YC2Z-1V102-EA</td> <td>HUB AND DISC A</td> <td>183.30</td> <td>366.60</td> </tr> <tr> <td>2</td> <td>1C2Z-1S175-BA</td> <td>RETAINER - GRE</td> <td>18.13</td> <td>36.26</td> </tr> <tr> <td colspan="3">TOTAL - PARTS</td> <td></td> <td>402.86</td> </tr> </tbody> </table>				QTY	FP-NUMBER	DESCRIPTION	UNIT PRICE	PRICE	2	YC2Z-1V102-EA	HUB AND DISC A	183.30	366.60	2	1C2Z-1S175-BA	RETAINER - GRE	18.13	36.26	TOTAL - PARTS				402.86		
QTY	FP-NUMBER	DESCRIPTION	UNIT PRICE	PRICE																					
2	YC2Z-1V102-EA	HUB AND DISC A	183.30	366.60																					
2	1C2Z-1S175-BA	RETAINER - GRE	18.13	36.26																					
TOTAL - PARTS				402.86																					
MISC <table border="1"> <thead> <tr> <th>CODE</th> <th>DESCRIPTION</th> <th>CONTROL NO</th> <th>PRICE</th> </tr> </thead> <tbody> <tr> <td>410</td> <td>FLEET CUSTOMER DISC - 20% SVC</td> <td></td> <td>-17.99</td> </tr> <tr> <td>411</td> <td>FLEET CUSTOMER DISC - 20% PTS</td> <td></td> <td>-80.57</td> </tr> <tr> <td colspan="3">TOTAL - MISC</td> <td>-98.56</td> </tr> </tbody> </table>				CODE	DESCRIPTION	CONTROL NO	PRICE	410	FLEET CUSTOMER DISC - 20% SVC		-17.99	411	FLEET CUSTOMER DISC - 20% PTS		-80.57	TOTAL - MISC			-98.56						
CODE	DESCRIPTION	CONTROL NO	PRICE																						
410	FLEET CUSTOMER DISC - 20% SVC		-17.99																						
411	FLEET CUSTOMER DISC - 20% PTS		-80.57																						
TOTAL - MISC			-98.56																						
JOB# 6 TOTALS LABOR 89.95 PARTS 402.86 MISC -98.56 JOB# 6 JOURNAL PREFIX FTCS JOB# 6 TOTAL 394.25				ANTIFREEZE PROTECTION																					
LABOR #17-03F0Z32 REPLE SWAY BAR BSHNG TECH(S): 2250 106.95 REPLACE SWAY BAR BUSHINGS IN I BEAM FOUND SWAY BAR BUSHINGS FELL OUT OF I-BEAM REPLACED FRONT SWAY BAR INSULATORS IN I-BEAM				YOUR VEHICLE IS PARKED IN SPOT # _____																					
PARTS <table border="1"> <thead> <tr> <th>QTY</th> <th>FP-NUMBER</th> <th>DESCRIPTION</th> <th>UNIT PRICE</th> <th>PRICE</th> </tr> </thead> <tbody> <tr> <td>2</td> <td>F2UZ-5K486-A</td> <td>BUSH</td> <td>23.45</td> <td>46.90</td> </tr> <tr> <td colspan="3">TOTAL - PARTS</td> <td></td> <td>46.90</td> </tr> </tbody> </table>				QTY	FP-NUMBER	DESCRIPTION	UNIT PRICE	PRICE	2	F2UZ-5K486-A	BUSH	23.45	46.90	TOTAL - PARTS				46.90							
QTY	FP-NUMBER	DESCRIPTION	UNIT PRICE	PRICE																					
2	F2UZ-5K486-A	BUSH	23.45	46.90																					
TOTAL - PARTS				46.90																					
MISC <table border="1"> <thead> <tr> <th>CODE</th> <th>DESCRIPTION</th> <th>CONTROL NO</th> <th>PRICE</th> </tr> </thead> <tbody> <tr> <td>410</td> <td>FLEET CUSTOMER DISC - 20% SVC</td> <td></td> <td>-21.39</td> </tr> <tr> <td>411</td> <td>FLEET CUSTOMER DISC - 20% PTS</td> <td></td> <td>-9.38</td> </tr> <tr> <td colspan="3">TOTAL - MISC</td> <td>-30.77</td> </tr> </tbody> </table>				CODE	DESCRIPTION	CONTROL NO	PRICE	410	FLEET CUSTOMER DISC - 20% SVC		-21.39	411	FLEET CUSTOMER DISC - 20% PTS		-9.38	TOTAL - MISC			-30.77						
CODE	DESCRIPTION	CONTROL NO	PRICE																						
410	FLEET CUSTOMER DISC - 20% SVC		-21.39																						
411	FLEET CUSTOMER DISC - 20% PTS		-9.38																						
TOTAL - MISC			-30.77																						
JOB# 7 TOTALS LABOR 106.95 PARTS 46.90 MISC -30.77 JOB# 7 JOURNAL PREFIX FTCS JOB# 7 TOTAL 123.08																									
LABOR #18-03F0Z20 REPLE BALL JOINT(S) TECH(S): 2250 321.95 REPLACE UPPER & LOWER BALL JOINTS ON BOTH SIDES RIGHT SIDE BALL JOINT LOOSE OUT OF SPEC LEFT SIDE BALL JOINTS NOT REUSABLE FROM DAMAGED SPINDLE INSTALL NEW UPPER AND LOWER BALL JOINTS BOTH SIDES FRONT																									

Everything Automotive

The Reynolds and Reynolds Company, EBAINITIVE CC081917 0 (08/10)

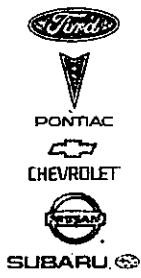

FRED BEANS FORD LINCOLN MERCURY MITSUBISHI

Route 611 & Sawmill Road
 Doylestown, PA 18901
 (215) 348-2900 Fax (215) 348-9435
 www.fredbeans.com



CELL: 267-221-1314

CUSTOMER NO. 21035	ADVISOR JESSE YEARS 1512	TAG NO. 5883	INVOICE DATE 01/17/12	INVOICE NO. FTGS620593
BUCKS COUNTY TRANSPORT 2444 DURHAM RD BRISTOL, PA 19007-6902	LABOR RATE	LICENSE NO. 135	MILEAGE 116,905	COLOR BLUE/WHITE/
	YEAR / MAKE / MODEL 06/FORD TRUCK/ECONO COM CTWAY/			STOCK NO.
	VEHICLE I.D. NO. 11F D X UEY 4 15 P 9 6 D B 4 3 7 7 19			DELIVERY DATE
	F.T.E. NO. 23237172 P.O. NO.			DELIVERY MILES
RESIDENCE PHONE 215-946-9357	BUSINESS PHONE 215-946-9357	COMMENTS	DATE COMPLETED 01/13/12	PRODUCTION DATE
			MILEAGE OUT 116912	

LABOR
 # 4-04FOZBEARING & CHECK WHEEL BEARINGS TECH(S): 2250 203.95
 REPLACE BOTH FRONT WHEEL BEARINGS AND SEALS
 FOUND LEFT FRONT WHEEL BEARINGS MELTED AND RIGHT FRONT LOOSE
 REPLACE BOTH SIDE WHEEL BEARINGS

PARTS	QTY	FP-NUMBER	DESCRIPTION	UNIT PRICE	PRICE
	2	BC2Z-4221-A	BEARING ASY -	38.20	76.40
	2	1C2Z-1S175-BA	RETAINER - GRE	18.13	36.26
	2	BC2Z-1216-A	CONE AND ROLLE	33.76	67.52
	2	E7TZ-1195-A	RING - BEARING	8.98	17.96
		12,13,14 W/H			
	2	-374504-S100	NUT - HEX.	6.41	12.82
	2	-374536-S	RETAINER - NUT	4.75	9.50
TOTAL - PARTS					220.46

MISC	CODE	DESCRIPTION	CONTROL NO	PRICE
	410	FLEET CUSTOMER DISC - 20% SVC		-40.79
	411	FLEET CUSTOMER DISC - 20% PTS		-44.09
TOTAL - MISC				-84.88

JOB# 4 TOTALS
 LABOR 203.95
 PARTS 220.46
 MISC -84.88
 JOB# 4 JOURNAL PREFIX FTCS JOB# 4 TOTAL 339.53

LABOR
 # 5-05FOZ18 REPL CALIPER(S) TECH(S): 2250 179.90
 REPLACE FRONT CALIPERS LOADED WITH PADS
 CALIPERS DAMAGED
 REPLACED BOTH FRONT CALIPERS AND BLEED BRAKES

PARTS	QTY	FP-NUMBER	DESCRIPTION	UNIT PRICE	PRICE
	1	PM-1-C	FLUID - BRAKE	4.78	4.78
	1	F7TZ-2V130-AARM	CALIPER WITH P	119.46	119.46
	1	F7TZ-2V131-AARM	CALIPER WITH P	119.46	119.46
TOTAL - PARTS					243.70

MISC	CODE	DESCRIPTION	CONTROL NO	PRICE
	410	FLEET CUSTOMER DISC - 20% SVC		-35.98
	411	FLEET CUSTOMER DISC - 20% PTS		-48.74
TOTAL - MISC				-84.72

JOB# 5 TOTALS
 LABOR 179.90
 PARTS 243.70
 MISC -84.72
 JOB# 5 JOURNAL PREFIX FTCS JOB# 5 TOTAL 338.88

JOB# 6 CHARGES

LABOR

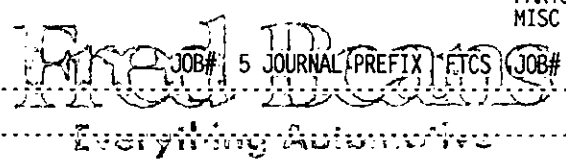

YOUR STATE INSPECTION
 EXPIRES _____

TIRES _____
 BRAKES _____

ANTIFREEZE
 PROTECTION

YOUR VEHICLE
 IS PARKED
 IN SPOT
 # _____

The Reynolds and Reynolds Company ERMANTIVE C0612137 Q (05/10)

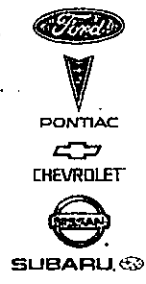

FRED BEANS FORD LINCOLN MERCURY MITSUBISHI
 Route 611 & Sawmill Road
 Doylestown, PA 18901
 (215) 348-2900 Fax (215) 348-9435
 www.fredbeans.com



CELL: 267-221-1314

CUSTOMER NO 21035	ADVISOR JESSE YEARS	1512	TAG NO. 5883	INVOICE DATE 01/17/12	INVOICE NO. FTCS620593
BUCKS COUNTY TRANSPORT 2444 DURHAM RD BRISTOL, PA 19007-6902	LABOR RATE	LICENSE NO 135	MILEAGE 116,905	COLOR BLUE/WHITE/	STOCK NO.
	YEAR / MAKE / MODEL 06/FORD TRUCK/ECONO COM CTWAY/			DELIVERY DATE	DELIVERY MILES
	VEHICLE I.D. NO. 1F1D1X4E45P961D8B43779			SELLING DEALER NO.	PRODUCTION DATE
RESIDENCE PHONE 215-946-9357	BUSINESS PHONE 215-946-9357	F.T.E. NO. 23237172		P.O. NO.	DATE COMPLETED 01/13/12
COMMENTS				MILEAGE OUT MO. 116912	

JOB# 1 CHARGES-----

LABOR
 #1105FOZ
 BRAKES TECH(S): 2250 0:00
 CUST STATES THAT THERE IS A STRONG SMELL OF HOT BRAKES FROM THE FRONT. RUBBING SOUND FROM THE LEFT FRONT. FOUND LEFT FRONT WHEEL BEARINGS FELL APART. CALIPER BRACKET HOLDING WHEEL ASSY ON TRUCK, SPINDLE DISCOLORED AND BEARING RACES FUSED TO SPINDLE CALIPER RUBBED THROUGH, ROTOR WARPED AND HEAT CRACKS. PADS WORN UNEVEN TO OMM
 REPLACED SPINDLE AND BEARINGS LEFT SIDE, NEW SEALS AND GREAS NEW BRAKES

JOB# 1 TOTALS-----
 JOB# 1 JOURNAL PREFIX FTCS JOB# 1 TOTAL 0.00

JOB# 2 CHARGES-----
 LABOR
 #1298FOZQ99P
 MULTIPOINT INSPECTIO TECH(S): 2250 0:00
 PERFORM COURTESY MULTI POINT INSPECTION
 PERFORMED 27 POINT COURTESY INSPECTION.
 TOPPED OFF FLUIDS AS NEEDED AND SET TIRE PRESSURE.

JOB# 2 TOTALS-----
 JOB# 2 JOURNAL PREFIX FTCS JOB# 2 TOTAL 0.00

JOB# 3 CHARGES-----
 LABOR
 #13+03FOZ
 STEERING SYSTEM TECH(S): 2250 203:95
 REPLACE LEFT FRONT SPINDLE
 SPINDLE DAMAGED
 REMOVE AND REPLACE SPINDLE

PARTS	QTY	FP NUMBER	DESCRIPTION	UNIT PRICE	
	1	9C2Z-3106-B	SPINDLE	291.28	291.28
				TOTAL - PARTS	291.28
MISC	CODE	DESCRIPTION	CONTROL NO		
	410	FLEET CUSTOMER DISC - 20% SVC		-40.79	
	411	FLEET CUSTOMER DISC - 20% PTS		-58.26	
				TOTAL - MISC	-99.05

JOB# 3 TOTALS-----
 LABOR 203.95
 PARTS 291.28
 MISC -99.05

JOB# 4 CHARGES-----
 JOB# 3 JOURNAL PREFIX FTCS JOB# 3 TOTAL 396.18

LABOR
Fred Beans
Everything Automotive

YOUR STATE INSPECTION
 EXPIRES _____
 TIRES _____ BRAKES _____
 ANTIFREEZE PROTECTION _____
YOUR VEHICLE IS PARKED IN SPOT
 # _____

The Reynolds and Reynolds Company BRAINTRIVE CC612137 O (05/10)



MULTI-POINT INSPECTION REPORT CARD

Customer Name: BET #135 Year/Model: 06 Ford Focus E450 Date: 1/31/12
 License Plate: BA606B1 VIN: 1FDPX145PA60B43779 RO/Tag: 620593
 Mileage: 11690 Service Advisor: Jesse Year Technician: 2160

CHECKED and OKAY MAY REQUIRE FUTURE ATTENTION REQUIRES IMMEDIATE ATTENTION NOT APPLICABLE

Check Every 5,000 (or 3,000) Miles

<input checked="" type="checkbox"/>	<input checked="" type="checkbox"/>	Windshield washer fluid level
<input checked="" type="checkbox"/>	<input checked="" type="checkbox"/>	Transmission fluid level
<input checked="" type="checkbox"/>	<input checked="" type="checkbox"/>	Brake fluid level
<input checked="" type="checkbox"/>	<input checked="" type="checkbox"/>	Power steering fluid level
<input checked="" type="checkbox"/>	<input checked="" type="checkbox"/>	Coolant recovery reservoir fluid level
<input checked="" type="checkbox"/>	<input checked="" type="checkbox"/>	4x4 transfer case, front drive axle, clutch reservoir fluid (truck only)
<input checked="" type="checkbox"/>	<input checked="" type="checkbox"/>	Operation of horn, interior lights, exterior lamps, turn signals, hazard and brake lamps
<input checked="" type="checkbox"/>	<input checked="" type="checkbox"/>	Windshield washer spray, wiper operation and wiper blades
<input checked="" type="checkbox"/>	<input checked="" type="checkbox"/>	Windshield for cracks, chips and pitting
<input checked="" type="checkbox"/>	<input checked="" type="checkbox"/>	Radiator, heater and air conditioning hoses for leaks and damage
<input checked="" type="checkbox"/>	<input checked="" type="checkbox"/>	Oil and/or fluid leaks
<input checked="" type="checkbox"/>	<input checked="" type="checkbox"/>	Constant velocity (CV) drive axle boots (if equipped)
<input checked="" type="checkbox"/>	<input checked="" type="checkbox"/>	Exhaust system (leaks, damage, loose parts)
<input checked="" type="checkbox"/>	<input checked="" type="checkbox"/>	Drive shaft, transmission, u-joint and shift linkage (if equipped) and lubricate (as needed)
<input checked="" type="checkbox"/>	<input checked="" type="checkbox"/>	Steering and steering linkages and lubricate
<input checked="" type="checkbox"/>	<input checked="" type="checkbox"/>	Suspension (shocks/struts for bounce/leaks/damage) and lubricate

Check Every 15,000 Miles (Plus Above)

<input checked="" type="checkbox"/>	<input checked="" type="checkbox"/>	Brake system (including lines, hoses and parking brake) and wheel
<input checked="" type="checkbox"/>	<input checked="" type="checkbox"/>	End for end-play and bearing noise
<input checked="" type="checkbox"/>	<input checked="" type="checkbox"/>	Engine cooling system, hoses and clamps

Check Every 30,000 Miles (Plus Above)

<input checked="" type="checkbox"/>	<input checked="" type="checkbox"/>	Accessory drive belt(s)
<input checked="" type="checkbox"/>	<input checked="" type="checkbox"/>	Battery terminals (clean if necessary)
<input checked="" type="checkbox"/>	<input checked="" type="checkbox"/>	Clutch operation
<input checked="" type="checkbox"/>	<input checked="" type="checkbox"/>	Evaporative fuel system hoses and tubes (only at 60,000 mile intervals pre-1999 vehicles)

Comments:

Check Battery Performance

Good Factory Spec Cold Cranking Amps

Recharge Actual Cold Cranking Amps

Bad

N/A

Measure Front/Rear Brake Linings

<input checked="" type="checkbox"/>	LF	<input checked="" type="checkbox"/>	RF
<input checked="" type="checkbox"/>		<input checked="" type="checkbox"/>	
<input checked="" type="checkbox"/>		<input checked="" type="checkbox"/>	
<input checked="" type="checkbox"/>		<input checked="" type="checkbox"/>	
<input checked="" type="checkbox"/>		<input checked="" type="checkbox"/>	
<input checked="" type="checkbox"/>		<input checked="" type="checkbox"/>	
<input checked="" type="checkbox"/>	LR	<input checked="" type="checkbox"/>	RR

Over 5mm (Disc) or Over 2mm (Drum)

3 to 5mm (Disc) or 1.01 to 2mm (Drum)

Less than 3mm (Disc) or 1mm or less (Drum)

Brake Measurements Not Taken This Service Visit

Check Tires

<input checked="" type="checkbox"/>	LF	TREAD DEPTH	<input checked="" type="checkbox"/>	RF
<input checked="" type="checkbox"/>		7/32 or Greater	<input checked="" type="checkbox"/>	7/32 or Greater
<input checked="" type="checkbox"/>		4/32 to 6/32	<input checked="" type="checkbox"/>	4/32 to 6/32
<input checked="" type="checkbox"/>		3/32 or less	<input checked="" type="checkbox"/>	3/32 or less
<input checked="" type="checkbox"/>		N/A	<input checked="" type="checkbox"/>	N/A
<input checked="" type="checkbox"/>			<input checked="" type="checkbox"/>	
<input checked="" type="checkbox"/>			<input checked="" type="checkbox"/>	
<input checked="" type="checkbox"/>			<input checked="" type="checkbox"/>	
<input checked="" type="checkbox"/>			<input checked="" type="checkbox"/>	
<input checked="" type="checkbox"/>	LR		<input checked="" type="checkbox"/>	RR

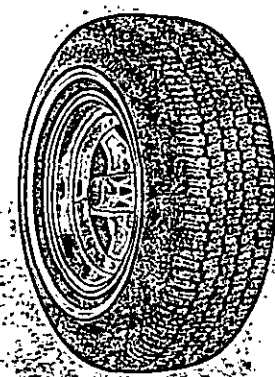

WEAR PATTERN / DAMAGE

<input checked="" type="checkbox"/>	<input checked="" type="checkbox"/>	LF	<input checked="" type="checkbox"/>	RF
<input checked="" type="checkbox"/>	<input checked="" type="checkbox"/>	LR	<input checked="" type="checkbox"/>	RR

Tire Pressure Set to FRONT REAR PSI

BUCKS COUNTY TRANSPORT, INC.

Payee FRED BEANS FORD-LINCOLN-MERCURY-
Vendor ID FREDBE

Account #:

50724
50724
2/28/2012

Invoice	Description	Discount	Amount
FTCS620593	Veh 135	\$0.00	\$2,134.88
FTCS620627	Veh 160	\$0.00	\$51.62

Total : \$0.00 \$2,186.50

PRODUCT PLM102 USE WITH 91500 ENVELOPE

Deluxe For Business 1-800-257-8354

PRINTED IN U.S.A.

A



#111



Jasper Engines & Transmissions Exchange, Inc.
PO Box 650 - 815 Warrasing Rd.
Jasper, IN 47547 800.827.7455

TERMS: Net 30 Days from Invoice Date
PAST DUE BALANCES are subject to a
FINANCE CHARGE of 1-1/2% per month periodic rate,
which is an ANNUAL PERCENTAGE RATE OF 18%

BILL TO:
BUCKS COUNTY TRANSPORT INC
PO BOX 510
HOLICONG, PA 189280510

SHIP TO:
BUCKS COUNTY TRANSPORT INC
2444 DURHAM RD
BRISTOL, PA 190076902

Inv#: 5149163
Acct#: 14334019

Date: 01/20/2012
Terms: NET 30
Tax#: 23-237-1722
PO#:

PH#: 215 946 9357

QUAN	STOCK# / PROD#	DESCRIPTION	UNIT PRICE	CORE	SKIDS	TOTAL
1.00	5698720 108403	4R100 7.3 2001	2,099.00	0.00	0.00	2,099.00
1.00	F7TZ-7F293AA	NEUTRAL SWITCH	29.00	0.00	0.00	29.00

ENTERED
1/24/12

59200-000-000-40

Shipped By: JET TRANSIT

Inq#: 7006428

Edward Heckel, Bus. Dir.

MERCHANDISE	CORES	SKIDS	TAX	TOTAL	INVOICE
2,128.00	0.00	0.00	0.00	2,128.00	INVOICE

IMPORTANT: TERMS OF SELLER'S LIMITED WARRANTY
ARE AVAILABLE AT: <http://www.jasperengines.com/warranty.pdf>

PLEASE REMIT TO: P.O. BOX 650 JASPER, IN 47547-0650



JASPER ENGINE & TRANSMISSION EXCHANGE, INC
PO BOX 650
JASPER IN 47547-0650
ADDRESS SERVICE REQUESTED

BUCKS COUNTY TRANSPORT INC
PO BOX 510
HOLICONG, PA 189280510

POSTED
JAN 25 2012

BUCKS COUNTY TRANSPORT, INC.
Payee JASPER ENGINE & TRANSMISSION
Vendor ID JASPER

Account #: 14334019

50728
50728
2/28/2012

Invoice	Description	Discount	Amount
5147034	TRANSMISSION FOR BUS #115	\$0.00	\$2,582.00
5149163	TRANSMISSION FOR BUS #111	\$0.00	\$2,128.00
5153908	TRANSMISSION FOR BUS #120	\$0.00	\$2,582.00
Total :		\$0.00	\$7,292.00

PRODUCT DLM102 USE WITH 91500 ENVELOPE

Deluxe For Business 1-800-257-8354

PRINTED IN U.S.A.





393

1939 East Lincoln Highway, Langhorne, PA 19047 215-945-8000 www.mccafferty.com

CELL: 267-446-7430

CUSTOMER NO. 8086	ADVISOR DARRIN ALIBERTO	TAG NO. 2408	INVOICE DATE 10/14/11	INVOICE NO. FOCS339842
BUCKS COUNTY TRANSPORT 2444 DURHAM RD BRISTOL, PA 19007-6902	LABOR RATE	LICENSE NO.	MILEAGE 275,877	COLOR WHITE
edhackett@bcctransport.org	YEAR / MAKE / MODEL 00/FORD TRUCK/ECONO CUTAWAY/VAN IE-45	DELIVERY DATE 08/03/00	DELIVERY MILES	STOCK NO.
	VEHICLE I.D. NO. 1FDXE45F7YHB55111	SELLING DEALER NO.	PRODUCTION DATE 05/03/00	
	R.T.E. NO. 23-2371722	P.O. NO.	R.O. DATE 10/05/11	
RESIDENCE PHONE 215-269-4630	BUSINESS PHONE 215-946-9357 x702	COMMENTS		MO: 275887

TOTALS

CASH CHECK CK NO. []

VISA MASTERCARD DISCOVER

AMER EXPRESS OTHER CHARGE

THANK YOU FOR YOUR BUSINESS!!

Eli Hackett (305) 393

CUSTOMER SIGNATURE

TOTAL LABOR	1467.95
TOTAL PARTS	1007.95
TOTAL SUBLET	0.00
TOTAL G.O.G.	0.00
TOTAL MISC CHG.	0.00
TOTAL MISC DISC.	371.38
TOTAL TAX	0.00
TOTAL INVOICE \$	2104.52

DISCLAIMER OF WARRANTIES

The only warranties, if any, applying to the part(s) and/or service are those offered by the manufacturer. The selling dealer hereby expressly disclaims all warranties, either expressed or implied, including any implied warranties of merchantability or fitness for a particular purpose, and neither assumes nor authorizes any other person to assume for it any liability in connection with the sale of this part(s) and/or service. Buyer shall not be entitled to recover from the selling dealer any consequential damages, damages to property, damages for loss of use, loss of time, loss of profits or income, or any other incidental damages.

ENTERED
10/18/11

59200-000-000-40



Make your next service appointment on-line at www.mccafferty.com

Reynolds and Reynolds ERMATIVE C060728 Q (08/06)

Thank You, We Appreciate Your Business!



1939 East Lincoln Highway, Langhorne, PA 19047 215-945-8000 www.mccafferty.com

CELL: 267-446-7430

CUSTOMER NO. 8086	ADVISOR DARRIN ALBERTO	2408	TAG NO. 4668	INVOICE DATE 10/14/11	INVOICE NO. FOCS339842
BUCKS COUNTY TRANSPORT 2444 DURHAM RD BRISTOL, PA 19007-6902 edhackett@bcctransport.org	LABOR RATE	LICENSE NO.	MILEAGE 275,877	COLOR WHITE/	STOCK NO.
	YEAR / MAKE / MODEL 00/FORD TRUCK/ECONO CUTAWAY/VAN E-45			DELIVERY DATE 08/03/00	DELIVERY MILES
	VEHICLE I.D. NO. 1FDXE45F7YHB55111			SELLING DEALER NO.	PRODUCTION DATE 05/03/00
	F.T.E. NO. 23-2371722		P.O. NO.	R.O. DATE 10/05/11	
RESIDENCE PHONE 215-269-4630	BUSINESS PHONE 215-946-9357 x702	COMMENTS			MO. 275887

JOB# 1 CHARGES

LABOR #1 04FOZDIAGTRANS 2TRANS DIAGNOSIS TECH(S): 2551 1467.95

CUSTOMER FEELS THAT THE VEHICLE HAS A TRANSMISSION CONCERN HAS CODES TRAN DIAG PERFORMED DRIVEABILITY DIAGNOSIS. FOUND TO HAVE LACK OF POWER. FOUND TO HAVE BAD INJECTORS. REPLACED #3 INJECTOR. RESTART VEHICLE. FOUND CYLINDER #6 LACKING. REPLACED CYLINDER #6 INJECTOR. ALSO FOUND TO HAVE CLOGGED EBP SENSOR AND HOSE. CLEANED HOSE AND REPLACED SENSOR. ROAD TEST.

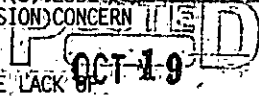

PARTS	QTY	FP NUMBER	DESCRIPTION	UNIT PRICE	
	2	15C3Z-9VE527-BRM	KIT - R	443.84	887.68
	1	4C3Z-9J460-A	SENSOR	116.77	116.77
	1	B7A-8287-A	CLAMP	3.50	3.50
TOTAL - PARTS					1007.95

MISC	CODE	DESCRIPTION	CONTROL NO	
	500	FLEET DISCOUNT 15%		220.19
	501	FLEET DISC PARTS		151.19
TOTAL - MISC				371.38

JOB# 1 TOTALS

LABOR	1467.95
PARTS	1007.95
MISC	371.38

JOB# 2 CHARGES

LABOR #2 01FOZ99P MULTI POINT TECH(S): 2551 0.00

MULTI-POINT INSPECTION SPECIAL
Perform Multi-Point Inspection All

JOB# 2 TOTALS

JOB# 2 JOURNAL PREFIX FOCS JOB# 2 TOTAL 0.00

ESTIMATE CUSTOMER HEREBY ACKNOWLEDGES RECEIVING ORIGINAL ESTIMATE OF \$99.95 (+TAX)

DISCLAIMER OF WARRANTIES
The only warranties, if any, applying to the part(s) and/or service are those offered by the manufacturer. The selling dealer hereby expressly disclaims all warranties, either expressed or implied, including any implied warranties of merchantability or fitness for a particular purpose, and neither assumes nor authorizes any other person to assume for it any liability in connection with the sale of this part(s) and/or service. Buyer shall not be entitled to recover from the selling dealer any consequential damages, damages to property, damages for loss of use, loss of time, loss of profits or income, or any other incidental damages.

IMPORTANT
You may receive a questionnaire from the manufacturer in the next few weeks. If for any reason you cannot grade us "Completely Satisfied" on each question please contact your service advisor.
McCAFFERTY AUTO GROUP
Phone 215-945-8000
www.mccafferty.com
THANK YOU!

Make your next service appointment on-line at www.mccafferty.com

Reynolds and Reynolds ERMANTIVE C0657208 0 (08/08)

BUCKS COUNTY TRANSPORT, INC.

49288

Payee McCAFFERTY FORD
Vendor ID MCCAFF

Account #:

49288
11/21/2011

Invoice	Description	Discount	Amount
FOCS336644	REPAIRED BLOWING SMOKE ON BUS #153	\$0.00	\$294.88
FOCS339842	REPLACED INJECTORS ON BUS #393	\$0.00	\$2,104.52
Total :		\$0.00	\$5,778.83

PRODUCT DLM102 USE WITH 91500 ENVELOPE

Deluxe For Business 1-800-257-8354

PRINTED IN U.S.A.





#131



1939 East Lincoln Highway, Langhorne, PA 19047 215-945-8000 www.mccafferty.com

CELL: 267-446-7430

CUSTOMER NO. 8086	ADVISOR DARRIN ALBERTO	TAG NO. 2408	INVOICE DATE 09/02/11	INVOICE NO. FOCS331818
BUCKS COUNTY TRANSPORT 2444 DURHAM RD BRISTOL, PA 19007-6902 edhackett@bcctransport.org	LABOR RATE	LICENSE NO. BA60675	MILEAGE 106,912	COLOR WHITE/
	YEAR / MAKE / MODEL 06/FORD TRUCK/ECONO CUTAWAY/VAN E-45		DELIVERY DATE 03/09/07	DELIVERY MILES
	VEHICLE I.D. NO. 1 F D X E 4 5 P 7 6 D B 4 3 7 8 1		SELLING DEALER NO.	PRODUCTION DATE 10/10/06
	F.T.E. NO. 23-2371722	P.O. NO.	R.O. DATE 08/22/11	
RESIDENCE PHONE 215-269-4630	BUSINESS PHONE 215-946-9357 x702	COMMENTS E# 10		MO: 106917

JOB# 4 CHARGES:

LABOR #4-13FOZ DIESEL ENG OPS TECH(S): 2539 WARRANTY
 CUSTOMER STATES THE DIESEL ENGINE IS NOT RUNNING PROPERLY

PARTS	QTY	FP NUMBER	DESCRIPTION	UNIT PRICE	WARRANTY
	4	4C3Z-9E527-BRM	NOZZLE		WARRANTY
	1	6E7Z-9A332-A	TUBE		WARRANTY
	1	-W302908	HARDWAR		WARRANTY
	1	-W302725	HARDWAR		WARRANTY
	2	-W300051	NUT - L		WARRANTY
	1	-W302352	HARDWAR		WARRANTY
	1	-W300006	BOLT		WARRANTY
	2	-N621906-S441	NUT - A		WARRANTY
	1	7C2Z-2C219-DA	CONTROL		WARRANTY
				TOTAL - PARTS	10.00

MISC CODE DESCRIPTION CONTROL NO. PRICE
 WE WARRANTY DEDUCTABLE - C 331818-04 115.47
 TOTAL - MISC 115.47

JOB# 4 TOTALS MISC 115.47
 JOB# 4 JOURNAL PREFIX FOCS JOB# 4 TOTAL 115.47

DISCLAIMER OF WARRANTIES
 The only warranties, if any, applying to the part(s) and/or service are those offered by the manufacturer. The selling dealer hereby expressly disclaims all warranties, either expressed or implied, including any implied warranties of merchantability or fitness for a particular purpose, and neither assumes nor authorizes any other person to assume for it any liability in connection with the sale of this part(s) and/or service. Buyer shall not be entitled to recover from the selling dealer any consequential damages, damages to property, damages for loss of use, loss of time, loss of profits or income, or any other incidental damages.

IMPORTANT
 You may receive a questionnaire from the manufacturer in the next few weeks. If for any reason you cannot grade us "Completely Satisfied" on each question please contact your service advisor
McCAFFERTY AUTO GROUP
 Phone 215-945-8000
 www.mccafferty.com
THANK YOU!

ESTIMATE
 CUSTOMER HEREBY ACKNOWLEDGES RECEIVING ORIGINAL ESTIMATE OF \$0.00 (+TAX)

TOTALS

TOTAL LABOR	1771.83
TOTAL PARTS	0.00
TOTAL SUBLET	0.00
TOTAL G.O.G.	0.00
TOTAL MISC CHG.	115.47
TOTAL MISC DISC	0.00
TOTAL TAX	0.00
TOTAL INVOICE \$	1887.30

THANK YOU FOR YOUR BUSINESS!!
 Ed Hackett
 CUSTOMER SIGNATURE

ENTERED
 9/7/11
 59200-000-000-94

Make your next service appointment on-line at
 www.mccafferty.com



1939 East Lincoln Highway, Langhorne, PA 19047 215-945-8000 www.mccafferty.com

CELL: 267-446-7430

CUSTOMER NO. 8086	ADVISOR DARRIN ALBERTO	TAG NO. 2408	INVOICE DATE 09/02/11	INVOICE NO. FOCS331818
BUCKS COUNTY TRANSPORT 2444 DURHAM RD BRISTOL, PA 19007-6902 edhackett@bctransport.org	LABOR RATE	LICENSE NO. BA60675	MILEAGE 106,912	COLOR WHITE
RESIDENCE PHONE 215-269-4630	BUSINESS PHONE 215-946-9357	COMMENTS E# 10	YEAR / MAKE / MODEL 06/FORD TRUCK/ECONO CUTAWAY/VAN-E45	DELIVERY DATE 03/09/07
			VEHICLE I.D. NO. 1FDXE45P76DB43781	DELIVERY MILES
			F.T.E. NO. 23-2371722	SELLING DEALER NO.
			P.O. NO.	R.O. DATE 08/22/11
				PRODUCTION DATE 10/10/06
				STOCK NO.
				MO. 106917

VEHICLE # 131
JOB# 1 CHARGES:
LABOR
J# 1 10FOZCHECKENG CHECK ENGINE LIGHT TECH(S): 2539 1117.88
CUST STATES CHECK ENGINE LIGHT IS ON
NO POWER AND STALLING
VERIFIED CONCERN PCM SELF TEST. KOEC CODES P0266 P0272
P2614 P2617 MONITOR PIDS. FICM MPWR AT 47.5V ICP AT 24V
KOE04590 PSI KOER FUEL PRESSURE AT 47 PSI USING LOAD TEST
GAUGE CK FOR COMBUSTION GAS IN FUEL AT SECONDARY FILTER
PRESENT BALLOON TEST ISOLATE TO BANK 2. PWR BALANCE CYLS
2/4/8 DROPPING OUT 50 MS. RELATIVE COMPRESSION 0 PERC
FAILED INJECTORS BANK 2. TIME TO R/I BUS DOOR CONTROLS AND
RADIO FOR ACCESS: R/I VACUUM PUMP AND PCM FOR ACCESS. R/I
INJECTOR COVER, OIL RAIL AND REPLACED ALL BANK 2 INJECTORS
CYLS: 2/4/6/8. CLEAR CODES AND ROAD TEST, OK RERUN SELF-TEST.
PASS

JOB# 1 TOTALS: LABOR 1117.88
JOB# 1 JOURNAL PREFIX FOCS JOB# 1 TOTAL 1117.88

JOB# 2 CHARGES:
LABOR
J# 2 05FOZ0015 ABS LIGHT ON TECH(S): 2539 653.95
CUSTOMER STATES ABS LIGHT IS COMING ON IN VEHICLE
VERIFIED. ABS SELF TEST. CODE C1095 OD AND MEMORY. PINPOINT
TESTING. CK FUSES, OK. CK POWER TO MODULE, 12.1V. CK MODULE
GROUND, 0.3 OHMS. CK MODULE CONNECTOR PINS, OK. INTERNAL
HCU PUMP FAILURE PER PPT 15. SERVICE BLEED HCU AND RE-TEST.
CODE C1095 RETURNS. REPLACED ABS MODULE PER PPT 16. RE-TEST.
PASS.

PARTS	QTY	FP-NUMBER	DESCRIPTION	UNIT PRICE	WARRANTY
	1	6C2Z-2C286-BA	CONTROL		0.00
TOTAL - PARTS					0.00

JOB# 2 TOTALS: LABOR 653.95
JOB# 2 JOURNAL PREFIX FOCS JOB# 2 TOTAL 653.95

JOB# 3 CHARGES:
LABOR
J# 3 01FOZ99P MULTI POINT TECH(S): 2539 0.00
MULTI POINT INSPECTION SPECIAL
Perform Multi Point Inspection A11

JOB# 3 TOTALS: LABOR 0.00
JOB# 3 JOURNAL PREFIX FOCS JOB# 3 TOTAL 0.00

DISCLAIMER OF WARRANTIES
The only warranties, if any, applying to the part(s) and/or service are those offered by the manufacturer. The selling dealer hereby expressly disclaims all warranties, either expressed or implied, including any implied warranties of merchantability or fitness for a particular purpose, and neither assumes nor authorizes any other person to assume for it any liability in connection with the sale of this part(s) and/or service. Buyer shall not be entitled to recover from the selling dealer any consequential damages, damages to property, damages for loss of use, loss of time, loss of profits or income, or any other incidental damages.

IMPORTANT
You may receive a questionnaire from the manufacturer in the next few weeks. If for any reason you cannot grade us "Completely Satisfied" on each question, please contact your service advisor
MCCAFFERTY AUTO GROUP
Phone: 215-945-8000
www.mccafferty.com
THANK YOU!

POSTED

Make your next service appointment on-line at
www.mccafferty.com

Reynolds and Reynolds ERMANTIVE C0557228 G. (9/07)

BUCKS COUNTY TRANSPORT, INC.

49055

Payee McCAFFERTY FORD
Vendor ID MCCAFF

Account #:

49055
10/24/2011

Invoice	Description	Discount	Amount
FOCS331818	INJECTORS REPLACED IN BUS #131	\$0.00	\$1,887.30
FOCS332554	REPLACED INJECTORS ON BUS #133	\$0.00	\$1,205.16
Total :		\$0.00	\$3,092.46

PRODUCT DLM102 USE WITH 91500 ENVELOPE

Deluxe For Business 1-800-257-8354

PRINTED IN U.S.A.





FRED BEANS FORD LINCOLN MERCURY MITSUBISHI

Route 611 & Sawmill Road
 Doylestown, PA 18901
 (215) 348-2900 Fax (215) 348-9435
 www.fredbeans.com



CELL: 267-446-7430

CUSTOMER NO. 7945554	ADVISOR JESSE YEARS	1512	TAG NO. 5654	INVOICE DATE 05/15/12	INVOICE NO. F.T.QS633220
BUCKS COUNTY TRANSPORT, INC. PO BOX 510 HOLICONG, PA 18928-0510	LABOR RATE	LICENSE NO. 137	MILEAGE 133,365	COLOR WHITE/FOZZ	STOCK NO.
	YEAR / MAKE / MODEL 06/FORD TRUCK/ECONO COM CTWAY/VAN E-			DELIVERY DATE	DELIVERY MILES
	VEHICLE I.D. NO. 17 F D X E 14 51 P 6 6 D B 14 3 7 8 76			SELLING DEALER NO.	PRODUCTION DATE
	F.T.E. NO. A00107294		P.O. NO.		05/10/12
RESIDENCE PHONE 215-794-5554	BUSINESS PHONE 215-946-9357 x103	COMMENTS		DATE COMPLETED	MILEAGE OUT MO: 133375

TOTALS

 * NEXT RECOMMENDED SERVICE:
 * 10/11/2012 / 1251 MI 31FOZF03.7 *MOBIL LUBE OIL FLTR

SURF THE WEB WITH FRED BEANS
 VISIT US AT www.fredbeans.com
 ALSO SAVE MONEY ON YOUR NEXT VISIT WITH OUR INTERNET COUPONS
 PLEASE REMEMBER TO RETURN YOUR MANUFACTURERS SURVEY COMPLETE
 WE APPRECIATE YOUR POSITIVE RESPONSE TO FORD MOTOR COMPANY!

 * HOUSE CHARGE [] ACCT#..... *
 * CASH [] CHECK [] #..... *
 * VISA [] MASTERCARD [] AMEX [] *
 * ACCEPTED BY..... DATE..... *

TOTAL LABOR... 595.90
 TOTAL PARTS... 1598.86
 TOTAL SUBLET... 0.00
 TOTAL G.O.G... 48.00
 TOTAL MISC CHG. 9.95
 TOTAL MISC DISC -457.16
 TOTAL TAX..... 0.00

TOTAL INVOICE \$ 1795.55

MAY 18 ENTD

YOUR STATE INSPECTION:
 EXPIRES _____

TIRES	BRAKES
+	+

ANTIFREEZE PROTECTION

YOUR VEHICLE IS PARKED IN SPOT

59200-000000-46

RECEIVED
MAY 17 2012

Fred Beans
 Everything Automotive



FRED BEANS FORD LINCOLN MERCURY MITSUBISHI

Route 611 & Sawmill Road
 Doylestown, PA 18901
 (215) 348-2900 Fax (215) 348-9435
 www.fredbeans.com



CELL: 267-446-7430

CUSTOMER NO. 7945554	ADVISOR JESSE YEARS	1512	TAG NO. 5654	INVOICE DATE 05/15/12	INVOICE NO. FTQS633220
BUCKS COUNTY TRANSPORT, INC. PO BOX 510 HOLICONG, PA 18928-0510	LABOR RATE	LICENSE NO. 137	MILEAGE 133,365	COLOR WHITE/FOZZ	STOCK NO.
	YEAR / MAKE / MODEL 06/FORD TRUCK/ECONO COM CTWAY/VAN E-	VEHICLE I.D. NO. 1 F D X E 4 5 5 P 6 6 D B 4 3 7 8 1 6		DELIVERY DATE	DELIVERY MILES
	F.T.E. NO. A00107294	P.O. NO.	05/10/12	SELLING DEALER NO.	PRODUCTION DATE
RESIDENCE PHONE 215-794-5554	BUSINESS PHONE 215-946-9357 x103	COMMENTS	DATE COMPLETED	MILEAGE OUT MO: 133375	REPRINT# 1
JOB# 6 CHARGES			YOUR STATE INSPECTION		
LABOR JOB# 6-05FOZGBK BRAKE CONDITION TECH(S): 2227 0:00 COMPLIMENTARY BRAKE PAD AND/ OR LINING CONDITION REPORTED IN THE "GREEN" ZONE. CONSTANT REVIEW OF COMPONENTS BEFORE ANY ADDITIONAL DAMAGE IS INCURRED OR SAFETY IS COMPROMISED. WE APPRECIATE YOU DOING BUSINESS WITH US! THERE ARE NO RECOMMENDATIONS REGARDING YOUR BRAKES AT THIS TIME. THANK YOU!			EXPIRES _____		
JOB# 6 TOTALS			TIRES _____ BRAKES _____		
JOB# 7 CHARGES			ANTIFREEZE PROTECTION		
LABOR JOB# 7-04FOZGTIRE TIRE CONDITION TECH(S): 2227 0:00 COMPLETED INSPECTION OF TIRES FOR CONDITION AND TREAD DEPTH CONTINUOUS MONITORING FOR TREAD LIFE TIRES ARE WITHING THE "GREEN" MARGINS FOR TREAD LIFE AT THIS TIME. FOLLOW INFLATION PLACARD FOR PROPER INFLATION PRESSURE TO MAXIMIZE LIFE OF THE TIRES.			YOUR VEHICLE		
JOB# 7 TOTALS			IS PARKED		
MISC - CODE - DESCRIPTION - CONTROL NO -			IN SPOT		
JOB # A 102 HAZ WASTE SHOP SUPPLIES CHARGE			# _____		
TOTAL - MISC 9.95					
ESTIMATE					
CUSTOMER HEREBY ACKNOWLEDGES RECEIVING ORIGINAL ESTIMATE OF \$1999.55 (+TAX)					
APPROVED REVISED ESTIMATE (# 1) OF \$1201.95 (+TAX) ON 05/10/12 AT 04:23pm					
BY ED HACKETT COMMENTS ED AUTHORIZED FICM HALF SHELL AND OIL CHANGE.					
APPROVED REVISED ESTIMATE (# 2) OF \$1795.55 (+TAX) ON 05/14/12 AT 03:33pm					
BY ED HACKETT COMMENTS 3 INJECTORS					
COMMENTS					
FORD CLP AND FRED BEANS WILL BE PAYING FOR THE #8 INJECTOR PARTS AND LABOR. CUSTOMER IS RESPONSIBLE FOR THE FICM AND PROGRAMING AND THE OTHER 3 INJECTORS IN THE SAME SIDE. PART COST ONLY.					
DELETED OPERATION(S)					
24FOZ08 REPL. FUEL INJECTOR					
RECOMMENDATIONS					
RECOMMEND SWAY BAR I-BEAM BUSHINGS & RADIUS ARM BUSHINGS					
RECOMMEND EGR SERVICE AND EGR VALVE P0404					
RECOMMEND FAN CLUTCH P0281					
TECH 2227					
<p>Everything Automotive</p>					

The Reynolds and Reynolds Company, ERANTIME, CCE19137, 0, (05/10)

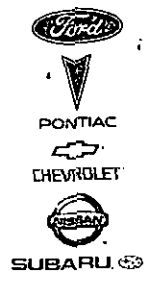

FRED BEANS FORD LINCOLN MERCURY MITSUBISHI

Route 611 & Sawmill Road
 Doylestown, PA 18901
 (215) 348-2900 Fax (215) 348-9435
 www.fredbeans.com

CELL: 267-446-7430

CUSTOMER NO. 7945554	ADVISOR JESSE YEARS	1512	TAG NO. 5654	INVOICE DATE 05/15/12	INVOICE NO. FTQS633220
BUCKS COUNTY TRANSPORT, INC. PO BOX 510 HOLICONG, PA 18928-0510	LABOR RATE	LICENSE NO. 137	MILEAGE 133,365	COLOR WHITE/FOZZ	STOCK NO.
	YEAR / MAKE / MODEL 06/FORD TRUCK/ECONO COM CTWAY/VAN E-			DELIVERY DATE	DELIVERY MILES
	VEHICLE I.D. NO. 1 FID XLE 415 P 6 6 ID B 4 3 7 8 16			SELLING DEALER NO.	PRODUCTION DATE
	F.T.E. NO. A00107294		P.O. NO.	05/10/12	REPRINT# 1
RESIDENCE PHONE 215-794-5554	BUSINESS PHONE 215-946-9357 x103	COMMENTS		DATE COMPLETED	MILEAGE OUT MO: 133375
TOTAL - GOG			48.00	YOUR STATE INSPECTION	
MISC-----CODE-----DESCRIPTION-----CONTROL NO-----	410 FLEET CUSTOMER DISC - 20% SVC		-15.37	EXPIRES _____	
411 FLEET CUSTOMER DISC - 20% PTS		-15.38	TIRES		
TOTAL - MISC		-30.75	BRAKES		
JOB# 3 TOTALS-----	LABOR		39.95	+	
PARTS		22.75	+		
G.O.G.		48.00	-		
MISC		-30.75	-		
JOB# 4 CHARGES-----	JOB# 3 JOURNAL PREFIX FTQS		79.95	ANTIFREEZE PROTECTION	
LABOR		JOB# 3 TOTAL		YOUR VEHICLE IS PARKED IN SPOT	
JOB# 4+28FOZ08		REPLACE #8 FUEL INJECTOR TESTS BAD		# _____	
CLP- CLAIM		TECH(S): 2227		WARRANTY	
#8 INJECTOR STUCK OPEN DUMPING FUEL IN CYLINDER		REPLACE #8, 2, 4, 6, INJECTORS, STAND PIPE, PLUG, AND 6 6MM NUTS THAT ROUNDED DURING R&R, ROAD TEST, INJECTORS WORK NORM		WARRANTY	
PARTS-----QTY-----FP-NUMBER-----DESCRIPTION-----UNIT PRICE-----	1 4C3Z-9E527-BRM		NOZZLE ASY	WARRANTY	
1 -W302908		HARDWARE - MIS		WARRANTY	
1 6E7Z-9A332-A		TUBE - FUEL SU		WARRANTY	
6 NPN		HARDWARE		WARRANTY	
3 4C3Z-9E527-BRM		NOZZLE ASY		WARRANTY	
TOTAL - PARTS		340.00	1020.00		
MISC-----CODE-----DESCRIPTION-----CONTROL NO-----		411 FLEET CUSTOMER DISC - 20% PTS		-204.00	
TOTAL - MISC		-204.00		-	
JOB# 4 TOTALS-----	PARTS		1020.00	-	
MISC		-204.00		-	
JOB# 5 CHARGES-----	JOB# 4 JOURNAL PREFIX FTQS		816.00	-	
LABOR		JOB# 4 TOTAL		-	
JOB# 5+36FOZGBATT		BATTERY CONDITION		0.00	
COMPLIMENTARY BATTERY INSPECTION FOR CONDITION THE STATE OF CHARGE		TECH(S): 2227		-	
RECOMMENDED TO CONSISTANTLY MONITOR BATTERY CONDITION		HAVE YOUR BATTERY CHECKED AT EVERY VISIT!		-	
JOB# 5 TOTALS-----	PARTS		0.00	-	
MISC		-204.00		-	
JOB# 5 TOTALS-----	JOB# 5 JOURNAL PREFIX FTQS		0.00	-	

Fred Beans
 Everything Automotive

The Reynolds and Reynolds Company ERFMTIVE C0612137 Q (05/10)



FRED BEANS FORD LINCOLN MERCURY MITSUBISHI

Route 611 & Sawmill Road
 Doylestown, PA 18901
 (215) 348-2900 Fax (215) 348-9435
 www.fredbeans.com



CELL: 267-446-7430

CUSTOMER NO. 7945554	ADVISOR JESSE YEARS	1512	TAG NO. 5654	INVOICE DATE 05/15/12	INVOICE NO. FTQS633220
BUCKS COUNTY TRANSPORT, INC. PO BOX 510 HOLICONG, PA 18928-0510	LABOR RATE	LICENSE NO. 137	MILEAGE 133,365	COLOR WHITE/FOZZ	STOCK NO.
	YEAR / MAKE / MODEL 06/FORD TRUCK/ECONO COM CTWAY/VAN E-			DELIVERY DATE	DELIVERY MILES
	VEHICLE I.D. NO. 1TF1D1XE451P1616D1B41371816			SELLING DEALER NO.	PRODUCTION DATE
	F.T.E. NO. A00107294		P.O. NO.		05/10/12
RESIDENCE PHONE 215-794-5554	BUSINESS PHONE 215-946-9357 x103	COMMENTS		DATE COMPLETED	MILEAGE OUT 133375

JOB# 1 CHARGES

LABOR
 #1:28F0Z DRIVEABILITY TECH(S):2227 555:95
 CUST STATES THAT THE TRUCK HAS BLACK SMOKE COMING FROM THE EXHAUST. CHECK AND ADVISE.
 RUN ENGINE DIAG, FOUND FICM DTC P0611, AND LOW SIDE DTCS FOR ALL 8 INJECTORS, FICM VOLTAGE DROPPING TO 39 VOLTS. NEEDS FICM HALF SHELL AND RE DIAG/RETEST
 REPLACE FICM HALF SHELL .REPROGRAM FICM,TCM AND PCM.

PARTS	QTY	FP-NUMBER	DESCRIPTION	UNIT PRICE	PRICE
	1	4C3Z-12B599-BARM	MODULE - ENGIN	556.11	556.11
TOTAL - PARTS					556.11
MISC	CODE	DESCRIPTION	CONTROL NO.		
	410	FLEET CUSTOMER DISC - 20% SVC		-111.19	
	411	FLEET CUSTOMER DISC - 20% PTS		-111.22	
TOTAL - MISC					-222.41

JOB# 1 TOTALS
 LABOR 555.95
 PARTS 556.11
 MISC -222.41
 JOB# 1 JOURNAL PREFIX FTQS JOB# 1 TOTAL 889.65

JOB# 2 CHARGES

LABOR
 #2:98F0Z099P MULTIPOINT INSPECTIO TECH(S):2227 0:00
 PERFORM COURTESY MULTI POINT INSPECTION
 PERFORMED 27 POINT COURTESY INSPECTION.
 TOPPED OFF FLUIDS AS NEEDED AND SET TIRE PRESSURE.

JOB# 2 TOTALS
 JOB# 2 JOURNAL PREFIX FTQS JOB# 2 TOTAL 0.00

JOB# 3 CHARGES

LABOR
 #3:32F0ZDIESEL DIESEL LUBE OIL FLET TECH(S):2227 39:95
 FRED BEANS "16 POINT QUALITY SERVICE"-YOU DON'T ALWAYS GET WHAT YOU PAY FOR..SOMETIMES YOU GET MORE! OIL&FILTER CHANGE
 LUBE CHASIS,LOCKS,LATCHES&HINGES-INSPECT ALL FLUIDS,HOSES, BLETS, UNDERCARRIAGE, BATTERY, TIRE WEAR AND AIR PRESSURE
 CHECK OPERATION OF HORN, WIPERS AND DIRECTIONAL SIGNALS
 ADD WASHER SOLVENT = ROAD TEST (CONDITIONS PERMITTING)

PARTS	QTY	FP-NUMBER	DESCRIPTION	UNIT PRICE	PRICE
	1	3C3Z-6731-AA	FL-2016	22.75	22.75
TOTAL - PARTS					22.75
G.O.G. & SUPPLIES	15.0	15W40 CJ-4 DIESEL	@ 3.200 /UNIT		48.00

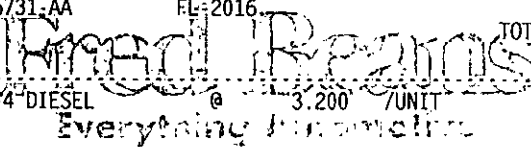

YOUR STATE INSPECTION
 EXPIRES _____
 TIRES _____ BRAKES _____
 ANTIFREEZE PROTECTION
YOUR VEHICLE IS PARKED IN SPOT
 # _____

The Reynolds and Reynolds Company, ERANTINIVE, CC812137 C (05/10)



MULTI-POINT INSPECTION REPORT CARD

Customer Name: Bucks County Transport Year/Model: 06 FORD E450 BUS Date: 5-10-12

License Plate: #137 VIN: 1FDXEK15P66DB43786 RO/Tag: 633220

Mileage: 133,365 Service Advisor: Jesse Technician: 2227

CHECKED and OKAY **MAY REQUIRE FUTURE ATTENTION** **REQUIRES IMMEDIATE ATTENTION** **NOT APPLICABLE**

Check Every 5,000 (or 3,000) Miles

- Windshield washer fluid level
- Transmission fluid level
- Brake fluid level
- Power steering fluid level
- Coolant recovery reservoir fluid level
- 4x4 transfer case, front drive axle, clutch reservoir fluid (truck only)
- Operation of horn, interior lights, exterior lamps, turn signals, hazard and brake lamps
- Windshield washer spray, wiper operation and wiper blades
- Windshield for cracks, chips and pitting
- Radiator, heater and air conditioning hoses for leaks and damage
- Oil and/or fluid leaks
- Constant velocity (CV) drive axle boots (if equipped)
- Exhaust system (leaks, damage, loose parts)
- Drive shaft, transmission, u-joint and shift linkage (if equipped) and lubricate (as needed)
- Steering and steering linkages and lubricate
- Suspension (shocks/struts for bounce/leaks/damage) and lubricate

Check Every 15,000 Miles (Plus Above)

- Brake system (including lines, hoses and parking brake) and wheel
- End for end-play and bearing noise
- Engine cooling system, hoses and clamps

Check Every 30,000 Miles (Plus Above)

- Accessory drive belt(s)
- Battery terminals (clean if necessary)
- Clutch operation
- Evaporative fuel system hoses and tubes (only at 60,000 mile intervals pre-1999 vehicles)

Comments: _____

Check Battery Performance

- Good
 - Recharge
 - Bad
 - N/A
- Factory Spec Cold Cranking Amps: 750
Actual Cold Cranking Amps: _____

Measure Front/Rear Brake Linings

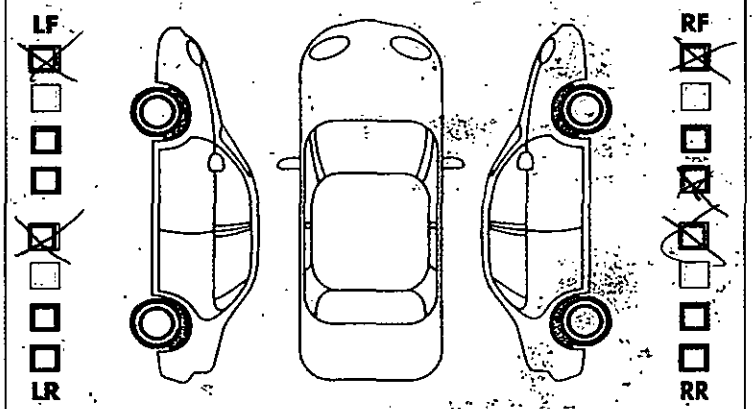

Over 5mm (Disc) or Over 2mm (Drum)

3 to 5mm (Disc) or .01 to 2mm (Drum)

Less than 3mm (Disc) or 1mm or less (Drum)

Brake Measurements Not Taken This Service Visit

Check Tires

TREAD DEPTH

<input checked="" type="checkbox"/> 7/32 or Greater		<input checked="" type="checkbox"/> 7/32 or Greater
<input type="checkbox"/> 4/32 to 6/32		<input type="checkbox"/> 4/32 to 6/32
<input type="checkbox"/> 3/32 or less		<input type="checkbox"/> 3/32 or less
<input type="checkbox"/> N/A		<input type="checkbox"/> N/A
<input checked="" type="checkbox"/> 7/32 or Greater		<input checked="" type="checkbox"/> 7/32 or Greater

LF RF
FR RR

WEAR PATTERN / DAMAGE

LF RF
FR RR

Tire Pressure Set to: FRONT _____ REAR _____ PSI
Factory Recommended

BUCKS COUNTY TRANSPORT, INC.

52184

Payee FRED BEANS FORD-LINCOLN-MERCURY-

52184

Vendor ID FREDBE

Account #:

6/18/2012

Invoice	Description	Discount	Amount
FTQS632409	Veh 161	\$0.00	\$26.90
FTQS633220	Veh 137	\$0.00	\$1,795.55
FTQS633930	Veh #148	\$0.00	\$272.06
Total :		\$0.00	\$2,094.51

PRODUCT DLM102 USE WITH 91500 ENVELOPE

Deluxe For Business 1-800-257-8354

PRINTED IN U.S.A

A





119



1939 East Lincoln Highway, Langhorne, PA 19047 215-945-8000 www.mccafferty.com

CELL: 267-446-7430

CUSTOMER NO. 8086	ADVISOR DARRIN ALIBERTO 2408	TAG NO. 4304	INVOICE DATE 01/12/12	INVOICE NO. FOC5352454
BUCKS COUNTY TRANSPORT 2444 DURHAM RD BRISTOL, PA 19007-6902	LABOR RATE	LICENSE NO. BA56832	MILEAGE 95,854	COLOR WHITE
edhackett@bctransport.org	YEAR / MAKE / MODEL 06 / FORD TRUCK / ECONO CUTAWAY / VAN E-45	DELIVERY DATE 12/23/05	STOCK NO.	DELIVERY MILES
RESIDENCE PHONE 215-269-4630	BUSINESS PHONE 215-946-9357 x702	VEHICLE I.D. NO. IFDXE45P16HA97356	SELLING DEALER NO.	PRODUCTION DATE 09/19/05
COMMENTS: Perform Multi-Point Inspection All		F.T.E. NO. 23-2371722	P.O. NO.	R.O. DATE 12/14/11
				MO: 95859

ESTIMATE

CUSTOMER HEREBY ACKNOWLEDGES RECEIVING ORIGINAL ESTIMATE OF \$0.00 (+TAX)

COMMENTS: NA

TOTALS

*****	TOTAL LABOR.....	1786.88
*****	TOTAL PARTS.....	0.00
*****	TOTAL SUBLET.....	0.00
*****	TOTAL G.O.G.....	0.00
*****	TOTAL MISC CHG.....	163.06
*****	TOTAL MISC DISC.....	268.03
*****	TOTAL TAX.....	0.00
*****	TOTAL INVOICE \$	1681.91

DISCLAIMER OF WARRANTIES

The only warranties, if any, applying to the part(s) and/or service are those offered by the manufacturer. The selling dealer hereby expressly disclaims all warranties, either expressed or implied, including any implied warranties of merchantability or fitness for a particular purpose, and neither assumes nor authorizes any other person to assume for it any liability in connection with the sale of this part(s) and/or service. Buyer shall not be entitled to recover from the selling dealer any consequential damages, damages to property, damages for loss of use, loss of time, loss of profits or income, or any other incidental damages.

THANK YOU FOR YOUR BUSINESS!!

Edmund Hackett Bus # (119)

CUSTOMER SIGNATURE



ENTERED 01/12

59200-000-000-20

POSTED JAN 1

Make your next service appointment on-line at www.mccafferty.com

Reynolds and Reynolds - BRAUNTOWN, OH (800) 225-2266



1939 East Lincoln Highway, Langhorne, PA 19047 215-945-8000 www.mccafferty.com

CELL: 267-446-7430

CUSTOMER NO. 8086	ADVISOR DARRIN ALIBERTO	TAG NO. 2408	4304	INVOICE DATE 01/12/12	INVOICE NO. FOCS352454
BUCKS COUNTY TRANSPORT 2444 DURHAM RD BRISTOL, PA 19007-6902	LABOR RATE	LICENSE NO. BA56832	MILEAGE 95,854	COLOR WHITE	STOCK NO.
edhackett@bctransport.org	YEAR / MAKE / MODEL 06 / FORD TRUCK / ECONO CUTAWAY / VAN E-45	VEHICLE I.D. NO. 1FDXE45P16HA97356		DELIVERY DATE 12/23/05	DELIVERY MILES
	F.T.E. NO. 23-2371722	P.O. NO.	R.O. DATE 12/14/11	PRODUCTION DATE 09/19/05	

RESIDENCE PHONE: 215-269-4630 BUSINESS PHONE: 215-946-9357 x702 COMMENTS: IMO: 95859

VEHICLE # J #119
JOB# 1 CHARGES

LABOR # 1202FOZ0000 FLUID BLEAK TECH(S): 2551 WARRANTY

CUST STATES OIL LEAK UNDER TRUCK
Y15E5.W02.1475:00LINE 01 DO NOT DELETE THIS INFORMATION
PERFORMED DIESEL ENGINE DIAGNOSIS. FOUND TO HAVE OIL IN COOLING SYSTEM. PERFORMED PRESSURE TESTS. REPLACED ENGINE COOLER. EGR COOLER. FLUSH COOLING SYSTEM.

PARTS	QTY	FP-NUMBER	DESCRIPTION	UNIT PRICE	WARRANTY
	1	3C3Z-6A642-CA	KIT		WARRANTY
	1	4C3Z-9P456-AJ	COOLER		WARRANTY
	1	4C2Z-8260-EA	HOSE AS		WARRANTY
	1	4C2Z-8286-FD	HOSE AS		WARRANTY
	1	9C3Z-8101-B	CAP - R		WARRANTY
	1	4C2Z-8A080-AA	TANK AS		WARRANTY
	1	5C3Z-9F452-AA	VALVE A		WARRANTY
	1	5C3Z-9424-C	KIT - M		WARRANTY
	2	3C3Z-9439-AA	GASKET		WARRANTY
	1	3C3Z-12A697-AA	SENSOR		WARRANTY
	1	FL-2016	KIT - E		WARRANTY
	4	VC-7-B	ANTI-FR		WARRANTY
TOTAL - PARTS				0.00	

MISC	CODE	DESCRIPTION	CONTROL NO	
		WE WARRANTY DEDUCTABLE - C	352454-01	163.06
TOTAL - MISC				163.06

JOB# 1 TOTALS MISC 163.06

JOB# 2 CHARGES JOB# 1 JOURNAL PREFIX FOCS JOB# 1 TOTAL 163.06

LABOR # 210FOZDIAGDRV DRIVEABILITY DIAG TECH(S): 2551 1786.88

CUST STATES FUEL IN COOLANT
REPLACED UPPER AND LOWER RADIATOR HOSES.

MISC	CODE	DESCRIPTION	CONTROL NO	
	500	FLEET DISCOUNT 15%		268.03
TOTAL - MISC				268.03

JOB# 2 TOTALS LABOR 1786.88 MISC 268.03

JOB# 3 CHARGES JOB# 2 JOURNAL PREFIX FOCS JOB# 2 TOTAL 1518.85

LABOR # 301FOZ99P MULTI-POINT TECH(S): 2551 0.00

MULTI-POINT INSPECTION SPECIAL

DISCLAIMER OF WARRANTIES
The only warranties, if any, applying to the part(s) and/or service are those offered by the manufacturer. The selling dealer hereby expressly disclaims all warranties, either expressed or implied, including any implied warranties of merchantability or fitness for a particular purpose, and neither assumes nor authorizes any other person to assume for it any liability in connection with the sale of this part(s) and/or service. Buyer shall not be entitled to recover from the selling dealer any consequential damages, damages to property, damages for loss of use, loss of time, loss of profits or income, or any other incidental damages.

IMPORTANT
You may receive a questionnaire from the manufacturer in the next few weeks. If for any reason you cannot grade us, completely satisfied on each question, please contact your service advisor. **McCAFFERTY AUTO GROUP**
Phone: 215-945-8000
www.mccafferty.com
THANK YOU!

POSTED
JAN 18 ENT D

Make your next service appointment on-line at www.mccafferty.com

Reynolds and Reynolds - EPANTINVE C0857228 0 (06/06)

Thank You, We Appreciate Your Business!

BUCKS COUNTY TRANSPORT, INC.

Payee McCAFFERTY FORD
 Vendor ID MCCAFF

Account #:

50980
 50980
 3/14/2012

Invoice	Description	Discount	Amount
14983 -	SWITCH, HARNESS, CONNECTORS	\$0.00	\$121.74
15001 -	OIL COOLER	\$0.00	\$83.12
15071 -	BOLT ASSEMBLY; NUTS	\$0.00	\$22.08
15113 -	SWITCHES	\$0.00	\$38.32
15161 -	RESONATOR; TUBE; ELEMENT	\$0.00	\$143.91
15240 -	SWITCHES	\$0.00	\$36.22
15247 -	HARNESS	\$0.00	\$48.96
15266 -	SENSOR	\$0.00	\$59.13
15317 -	TUBE; PLUNGER; BUSHINGS; CLAMPS AND SCREWS	\$0.00	\$79.60
15357 -	CABLE ASSEMBLY	\$0.00	\$45.73
FOCS352454 -	REPAIRED OIL LEAK BY REPLACING ENGINE COOLER O...	\$0.00	\$1,681.91
FOCS354560 ✓	REPAIRED NO POWER ON BUS #128	\$0.00	\$142.25
Total :		\$0.00	\$2,502.97





McElhaney Service Center

1100 Old Route 309
Sellersville, PA 18960
Phone: (215) 257-2511

INVOICE

Page 1 of 1



Complete Car Care: Cars, Trucks, Trailers

Bucks County Transport, Inc. Buckingham Green II, Suite 2 26 North 4th St., Quakertown Holicong, PA 18928-	Vehicle: 06 Ford E-450 Super Duty VIN: 1FDXE45P56DB18555 License: BA59535 Fleet ID: 130 Mileage: 137,852	Inv #: A014738 Date: 04/27/12 PO #: Tech: 003 Writer: 004
---	---	---

Office: (215) 529-5729	Business: (215) 794-5554 Ext: 512	Ed: (215) 946-9357
------------------------	-----------------------------------	--------------------

Description	Ref/Num	Qty	Unit Price	Parts	Service
Check A/C System For Problem. Found Vaccum Pump Not Functioning And Replaced.	401				128.84
Vaccum Pump	4C2Z2A451AA	1.0		287.89	
Also Found Compressor Not Functioning. Evacuated A/C System. R&R Fan, Both Shrouds, Fresh Air Intake System For Turbo, And Other Peripherals. Replace A/C Compressor. Evacuate System Again, Then Recharge System With R-134 and Oil.	40414				455.22
A/C Compressor	98564	1.0		375.95	
Page Oil 46	COP46-8D	5.0	3.36	16.80	
Serpentine Belt	K060960	1.0		57.62	
Fan Shroud	5C3Z8B614DA	1.0		314.97	
R 134 Freon	007	2.0	17.90	35.80	

Handwritten: Veh #130

Handwritten: 59200 0000040

Stamp: MAY 8 ENTN

Stamp: POSTED MAY 9 ENTN

Stamp: RECEIVED MAY 8 2012

<p>Because we take pride in the quality of the work we perform, your satisfaction is important to us. We encourage any questions, comments or concerns you may have, be made known to us. All work is warranted for a period of 12,000 miles or one (1) year, whichever occurs first, unless otherwise specified, on parts and labor supplied by us. All warranty work must be performed by us. Liability shall not extend beyond the cost of the original repair, nor shall it include incidental damages i.e., towing, lost wages etc. By receiving your vehicle, you understand and acknowledge acceptance of the terms and charges contained herein. An express mechanic's lien is hereby acknowledged on the above vehicle to secure the amount of the repairs thereto.</p>	Date: _____	Service 584.06
	Rec'd by: _____	Parts 1,089.03
Pay type: _____	Supply Fees 2.00	Non-taxable 1,675.09
Amt Paid: _____	Taxable 0.00	Sub-Total 1,675.09
Balance: 1,675.09	Thank You	Sales Tax 0.00
<p>VEH #130 Please sign here: <i>Clayton D. [Signature]</i> <i>May 12</i> Date: <i>7 May 12</i></p>		Inv Total 1,675.09

BUCKS COUNTY TRANSPORT, INC.
Payee McELHANEY SERVICE CENTER
Vendor ID MCELHA

Account #:

51977
51977
5/30/2012

Invoice	Description	Discount	Amount
A014738	Veh 130	\$0.00	\$1,675.09
A014781	Veh 137	\$0.00	\$421.09
Total :		\$0.00	\$2,096.18

PRODUCT DLM102 USE WITH 91500 ENVELOPE

Deluxe For Business 1-800-257-8354

PRINTED IN U.S.A



Handwritten: # 710



Jasper Engines & Transmissions Exchange, Inc.
PO Box 650 - 815 Warrasing Rd.
Jasper, IN 47547 800-827-7455

TERMS: Net 30 Days from Invoice Date
PAST DUE BALANCES are subject to a
FINANCE CHARGE of 1-1/2% per month periodic rate,
which is an ANNUAL PERCENTAGE RATE OF 18%

BILL TO:
BUCKS COUNTY TRANSPORT INC
PO BOX 510
HOLICONG, PA 189280510

SHIP TO:
BUCKS COUNTY TRANSPORT INC
2444 DURHAM RD
BRISTOL, PA 190076902

Inv#: 4895665.4
Acct#: 14334019 \$
Date: 06/01/2011
Terms: NET 30
Tax#: 23-237-1722
PO#: ED

PH#: 215 946 9357

QUAN	STOCK# / PROD#	DESCRIPTION	UNIT PRICE	CORE	SKIDS	TOTAL
1.00	5529960 017094	4T65E 2005 3.4L	1,636.00	0.00	0.00	1,636.00

POSTED
6/10/11

ENTERED
6/7/11

Handwritten: 59200-000-000-20

Jerharri Aprvd

Shipped By: JET TRANSIT

Inq#: 6638884

MERCHANDISE	CORES	SKIDS	TAX	TOTAL	INVOICE
1,636.00	0.00	0.00	0.00	1,636.00	

IMPORTANT: TERMS OF SELLER'S LIMITED WARRANTY
ARE AVAILABLE AT: <http://www.jasperengines.com/warranty.pdf>

PLEASE REMIT TO: P.O. BOX 650, JASPER, IN 47547-0650

Handwritten signature: Edward... Van # (710)



JASPER ENGINE & TRANSMISSION EXCHANGE, INC
PO BOX 650
JASPER IN 47547-0650
ADDRESS SERVICE REQUESTED

BUCKS COUNTY TRANSPORT INC
PO BOX 510
HOLICONG, PA 189280510

BUCKS COUNTY TRANSPORT, INC.

47392

Payee JASPER ENGINE & TRANSMISSION
Vendor ID JASPER

Account #: 14334019

47392
7/12/2011

Invoice	Description	Discount	Amount
4895665	TRANSMISSION FOR VAN #710	\$0.00	\$1,636.00
4910143	TRANSMISSION FOR VANN #708	\$0.00	\$1,638.00

Total : \$0.00 \$3,274.00

PRODUCT DLM102 USE WITH 91500 ENVELOPE

Deluxe For Business 1-800-257-8354

PRINTED IN U.S.A.

A



708



Jasper Engines & Transmissions Exchange, Inc.
PO Box 650 - 815 Wharfedale Rd.
Jasper, IN 47547 800.827.7455

TERMS: Net 30 Days from Invoice Date
PAST DUE BALANCES are subject to a
FINANCE CHARGE of 1-1/2% per month periodic rate,
which is an ANNUAL PERCENTAGE RATE OF 18%

BILL TO:
BUCKS COUNTY TRANSPORT INC
PO BOX 510
HOLICONG, PA 189280510

SHIP TO:
BUCKS COUNTY TRANSPORT INC
2444 DURHAM RD
BRISTOL, PA 190076902

Inv#: 4910143
Acct#: 14334019
Date: 06/14/2011
Terms: NET 30
Tax#: 23-237-1722
PO#: ED

PH#: 215 946 9357

QUAN	STOCK# / PROD#	DESCRIPTION	UNIT PRICE	CORE	SKIDS	TOTAL
1.00	5262300 996068	41TE 03 3.3 2WD	1,638.00	0.00	0.00	1,638.00

POSTED
6-23-11

ENTERED
6/20/11

59200-000-000-94

Jerhami Apprvd

Shipped By: JET TRANSIT

Inq#: 6659905

MERCHANDISE	CORES	SKIDS	TAX	TOTAL	INVOICE
1,638.00	0.00	0.00	0.00	1,638.00	

IMPORTANT: TERMS OF SELLER'S LIMITED WARRANTY
ARE AVAILABLE AT: <http://www.jasperengines.com/warranty.pdf>

PLEASE REMIT TO: P.O. BOX 650, JASPER, IN 47547-0650

Eduard Hachell / Van #708



JASPER ENGINE & TRANSMISSION EXCHANGE, INC
PO BOX 650
JASPER IN 47547-0650
ADDRESS SERVICE REQUESTED

BUCKS COUNTY TRANSPORT INC
PO BOX 510
HOLICONG, PA 189280510

BUCKS COUNTY TRANSPORT, INC.

47392

Payee JASPER ENGINE & TRANSMISSION

47392

Vendor ID JASPER

Account #: 14334019

7/12/2011

Invoice	Description	Discount	Amount
4895665	TRANSMISSION FOR VAN #710	\$0.00	\$1,636.00
4910143	TRANSMISSION FOR VANN #708	\$0.00	\$1,638.00

Total : \$0.00 \$3,274.00

PRODUCT DLM102 USE WITH 91500 ENVELOPE

Deluxe For Business 1-800-257-8354

PRINTED IN U.S.A.

A





REEDMAN TOLL

AUTO WORLD

1700 E. Lincoln Highway, Langhorne, PA 19047
215-757-4961 www.reedmantoll.com



#706

CELL: 267-446-7430

CUSTOMER NO. 161225	ADVISOR MATTHEW JOHN SNYDE 4790	TAG NO. 2431	INVOICE DATE 09/29/11	INVOICE NO. CHCS103629
BUCKS COUNTY TRANSPORT PO BOX 510 HOLICONG, PA 18928-0510	LABOR RATE	LICENSE NO.	MILEAGE 160,321	COLOR
	YEAR / MAKE / MODEL 05/DODGE/CARAVAN/VAN FWD SE		DELIVERY DATE	DELIVERY MILES
	VEHICLE I.D. NO. 1 D 4 G P 2 4 R 9 5 B 2 1 4 1 2 6		SELLING DEALER NO.	PRODUCTION DATE
	F.T.E. NO. 23-2371722	P.O. NO.	09/28/11	
RESIDENCE PHONE 215-946-9357	BUSINESS PHONE 215-946-9357	COMMENTS	DATE COMPLETED	MILEAGE OUT MO: 160323

JOB# 3 TOTALS-----
LABOR 44.95
MISC 5.00
JOB# 3 JOURNAL PREFIX CHCS JOB# 3 TOTAL 49.95

JOB# 4 CHARGES-----
LABOR-----
JOB# 4 00CHZ23PT 23 POINT CHECK TECH(S):4456 INTERNAL
PERFORM COURTESY 23 POINT VEHICLE INSPECTION
PERFORMED COURTESY 23 POINT CHECK

JOB# 4 TOTALS-----
JOB# 4 JOURNAL PREFIX CHCS JOB# 4 TOTAL 0.00

TOTALS-----

EXPRESS CENTER
HOURS AVAILABLE
M-F 7:30 AM to 9:00 PM
S 7:30 AM to 4:30 PM
and
NOW OPEN SUNDAY
9 AM to 4:30 PM

- 20 MINUTE OIL CHANGE
- EASY ON-LINE SCHEDULING
- CONVENIENT HOURS
- 7 DAY SERVICE

* NEXT RECOMMENDED SERVICE: *
* 09/26/2012 / 191564 MI 00CHZ004 STATE/EMISSION *

*****	TOTAL LABOR....	614.95
* [] CASH [] CHECK CK NO. [] *	TOTAL PARTS....	1006.35
* [] VISA [] MASTERCARD [] DISCOVER *	TOTAL SUBLET...	0.00
* [] AMER XPRESS [] OTHER [] CHARGE *	TOTAL G.O.G....	0.00
*****	TOTAL MISC CHG.	5.00
	TOTAL MISC DISC	0.00
	TOTAL TAX.....	0.00
	TOTAL INVOICE \$	1626.30

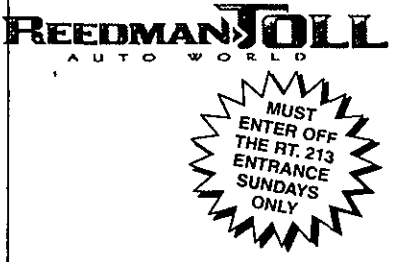

CUSTOMER SATISFACTION IS OUR GOAL!!!

ALL REPAIRS AND CHARGES HAVE BEEN EXPLAINED TO THE CUSTOMER

CUSTOMER INITIALS _____ DATE _____ TIME _____

ASM INITIALS _____ DATE _____ TIME _____

CUSTOMER EMAIL ADDRESS _____

REEDMAN TOLL BODY SHOP
OPEN
M-F 7:30 AM to 6:00 PM
Sat 7:30 AM to 1:00 PM
Estimators available 6 days a week for free estimates
No appointment necessary
(215) 757-4961

CUSTOMER SIGNATURE _____
Edward H. Van (706)

PAID
SEP 29 2011

ENTERED
10/5/11

59200-000-000-94

REEDMAN TOLL DISAPPEARING DEDUCTIBLE
Reedman Toll would like to pay for your deductible - up to \$500**

*Coupon must be presented at time of write up. Not valid with any other offer or advertised specials. Disappearing deductible amount based on 10% of estimate, up to \$500.

The Reynolds and Reynolds Company ERANTS/SLI/SE CC260196 G (09/11)



REEDMAN TOLL

AUTO WORLD

1700 E. Lincoln Highway, Langhorne, PA 19047
215-757-4961 www.reedmantoll.com



CELL: 267-446-7430

CUSTOMER NO. 161225	ADVISOR MATTHEW JOHN SNYDE	4790	TAG NO. 2431	INVOICE DATE 09/29/11	INVOICE NO. CHCS103629	
BUCKS COUNTY TRANSPORT PO BOX 510 HOLICONG, PA 18928-0510		LABOR RATE	LICENSE NO.	MILEAGE 160,321	COLOR	
		YEAR / MAKE / MODEL 05/DODGE/CARAVAN/VAN FWD SE			DELIVERY DATE	DELIVERY MILES
		VEHICLE I.D. NO. 1 D 4 G P 2 4 R 9 5 B 2 1 4 1 2 6			SELLING DEALER NO.	PRODUCTION DATE
		F.T.E. NO. 23-2371722	P.O. NO.		09/28/11	
RESIDENCE PHONE 215-946-9357	BUSINESS PHONE 215-946-9357	COMMENTS			DATE COMPLETED	MILEAGE OUT MO: 160323

JOB# 1 CHARGES

LABOR
1 51CHZ BODY ELECTRICAL TECH(S):4456 190.00
CUST ST AIRBAG LIGHT IS ON
DIAG.TIME AND REPAIR BROKEN LEFT FRONT IMPACT SENSOR
CONNECTOR 2.0 HRS.

PARTS	QTY	FP-NUMBER	DESCRIPTION	UNIT PRICE	PRICE
	2	CBX26092	WIRING NO 8015002	8.52	17.04
				TOTAL - PARTS	17.04

JOB# 1 TOTALS
LABOR 190.00
PARTS 17.04

JOB# 1 JOURNAL PREFIX CHCS JOB# 1 TOTAL 207.04

JOB# 2 CHARGES

LABOR
2 10CHZ06 CHECK ENGINE LIGHT TECH(S):4456 380.00
CUSTOMER STATES CHECK ENGINE LIGHT ON
REPLACE CAT.CONVERTER AND BOTH O2 SENSORS. 4.0 HRS.

PARTS	QTY	FP-NUMBER	DESCRIPTION	UNIT PRICE	PRICE
	1	4881034-AB	CONVERTER 14070004	1025.00	1025.00
	-1	4881034-AB	CORE RETURN	200.00	-200.00
	1	4881012-AC	GASKET EX 14062002	9.15	9.15
	1	4695220-AB	CLAMP EXH 14029007	16.95	16.95
	1	56029052-AA	SENSOR OX 8037155	72.61	72.61
	1	56029050-AA	SENSOR OX 8037155	50.12	50.12
	4	4682810-AB	NUT HEX F 14074004	2.59	10.36
	4	6101614	BOLT HEX 9004005	1.28	5.12
				TOTAL - PARTS	989.31

JOB# 2 TOTALS
LABOR 380.00
PARTS 989.31

JOB# 2 JOURNAL PREFIX CHCS JOB# 2 TOTAL 1369.31

JOB# 3 CHARGES

LABOR
3 00CHZ004 STATE/EMISSION TECH(S):4456 44.95
EMISSIONS ONLY
EMISSIONS ONLY
COMPLETED STATE INSPECTION - NO CHARGE
COMPLETED EMISSIONS INSPECTION - 44.95 PLUS STICKER FEES

ISC	CODE	DESCRIPTION	CONTROL NO	PRICE
	PAI	PA INSPECTION STICKERS		5.00
			TOTAL - MISC	5.00

EXPRESS CENTER
HOURS AVAILABLE
M-F 7:30 AM to 9:00 PM
S 7:30 AM to 4:30 PM
and
NOW OPEN SUNDAY
9 AM to 4:30 PM

- 20 MINUTE OIL CHANGE
- EASY ON-LINE SCHEDULING
- CONVENIENT HOURS
- 7 DAY SERVICE

REEDMAN TOLL
AUTO WORLD



REEDMAN TOLL
BODY SHOP
OPEN

M-F 7:30 AM to 6:00 PM
Sat 7:30 AM to 1:00 PM

Estimators available 6 days
a week for free estimates
No appointment necessary
(215) 757-4961

REEDMAN TOLL
DISAPPEARING DEDUCTIBLE

Reedman Toll would like
to pay for your
deductible - up to \$500**

*Coupon must be presented at time of write up. Not valid with any other offer or advertised specials. Disappearing deductible amount based on 10% of estimate, up to \$500.

The Reynolds and Reynolds Company EMMANTSIDE CO. (09/11)

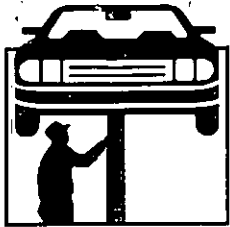

McElhaney Service Center

1100 Old Route 309
Sellersville, PA 18960
Phone: (215) 257-2511

Complete Car Care: Cars, Trucks, Trailers

INVOICE

Page 1 of 1



Bucks County Transport, Inc. Buckingham Green II, Suite 2 26 North 4th St., Quakertown, Holicong PA 18928-	Vehicle: 06 Ford E-450 Super Duty VIN: 1FDXE45P46DB43785 License: BA60678 Fleet ID: 136 Mileage: 133,362	Inv#: A013940 Date: 10/19/11 PO#: Tech: 003 Writer: 004
---	---	---

Office: (215) 529-5729	Business: (215) 794-5554 Ext: 512	Ed: (215) 946-9357
------------------------	-----------------------------------	--------------------

Description	Ref/Num	Qty	Unit Price	Parts	Service
Semi-Annual State Inspection	00020				60.59
Brakes: 8/B/LF 12/B/RR	Customer Note				
Tires: 9/32/LF 9/32/RF 7/7/32/LR 7/7/32/RR	Customer Note				
Sticker Semi-Annual	PA3	1.0		1.00	
Relpace Rear Brakes. (Dual Rear Wheels)	10110				171.78
Rear Brakes	MKD411	1.0		199.50	
Check For Coolant Leak. Pressurized System And	00038				515.34
Found Leak at Water Pump. Replaced Waterpump	"				
Belt, And Idler Pulley.	"				
Water Pump	4C3Z8501AC	1.0		223.89	
Idler Pulley	3C3Z8678EB	1.0		51.23	
R&R Dog Box And Repaired Coolant Hose For Front	40415				151.78
And Rear Heating System.	"				
Misc. Hardware	001	1.0		25.50	
Premium Gold Antifreeze	GOLD	1.5	19.98	29.97	
Resecured Transit Door Gasket And Trim	80001				68.71
Repair W/C Chair Lift, Adjusted Cables.	80823				42.95

59200-000-000-40

#136

NOV 1

RECT

NOV 1 ENTD

NOV 1

<p>Because we take pride in the quality of the work we perform, your satisfaction is important to us. We encourage any questions, comments or concerns you may have, be made known to us. All work is warranted for a period of 12,000 miles or one (1) year, whichever occurs first, unless otherwise specified, on parts and labor supplied by us. All warranty work must be performed by us. Liability shall not extend beyond the cost of the original repair, nor shall it include incidental damages i.e., towing, lost wages etc. By receiving your vehicle, you understand and acknowledge acceptance of the terms and charges contained herein. An express mechanic's lien is hereby acknowledged on the above vehicle to secure the amount of the repairs thereto.</p>	Date: _____	Service 1,011.15
	Rec'd by: _____	Parts 531.09
Pay type: _____	Supply Fees 2.00	Non-taxable 1,544.24
Amt Paid: _____	Taxable 0.00	Sub-Total 1,544.24
Balance: 1,544.24	Thank You	Sales Tax 0.00
		Inv Total 1,544.24

VEN #136

Please sign here: *Clayton R. Donawick* Nov 30 2011

BUCKS COUNTY TRANSPORT, INC.

49289

Payee McELHANEY SERVICE CENTER
Vendor ID MCELHA

Account #:

49289
11/21/2011

Invoice	Description	Discount	Amount
A013886	Veh 806	\$0.00	\$1,037.93
A013900	Veh #804	\$0.00	\$235.66
A013917	Veh #108	\$0.00	\$417.15
A013918	Veh 130	\$0.00	\$244.87
A013927	Veh #806	\$0.00	\$725.85
A013935	Veh 398	\$0.00	\$634.85
A013940	Veh #136	\$0.00	\$1,544.24
A013962	Veh #398	\$0.00	\$604.82
A013966	Veh #110	\$0.00	\$216.73
Total :		\$0.00	\$5,662.10

PRODUCT DLM102 USE WITH 91500 ENVELOPE

Deluxe For Business 1-800-257-8354

PRINTED IN U.S.A.



Executive Officers Job Descriptions

Vincent J. Volpe – Executive Director

Annual Salary \$49,575 (PUC portion)

Job Description -

- Directs and coordinates the operations of a non-for profit para-transit agency.
- Establishes and maintains cooperative relationship with county agencies to ensure coordinated transportation services.
- Prepares and updates short and long term strategic plan to ensure organization contributions to the overall plan and strategies of county agencies.
- Prepares budget in consultation with departmental directors to control cost and maintain operations and at a level consistent with company guild lines.
- Liaison with board of directors updating them on financial conditions, marketing, new business and policy and procedure changes to the organization.

James A. Raymond – Chief Financial Officer

Annual Salary \$44,726 (PUC Portion)

Job Description –

- Directs financial activities of organization.
- Prepares financial reports that summarize and forecast the company business activities and financial position in areas of revenue and expenses by program.
- Manages the accounting, human resources and administrative departments.
- Prepares and reports required information to regulator agencies.
- Advices management on desirable operation adjustments due to revision in transportation programs.
- Directs financial planning, procurements and investment of funds for the organization

BUCKS COUNTY TRANSPORT, INC.
P.O. BOX 510
HOLICONG, PA. 18928

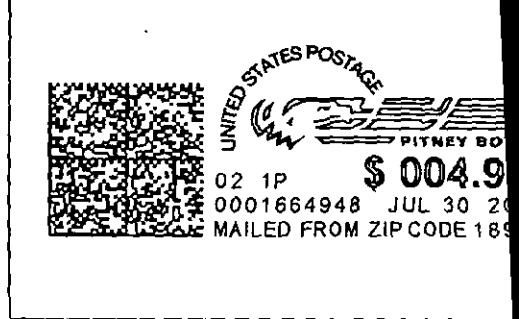
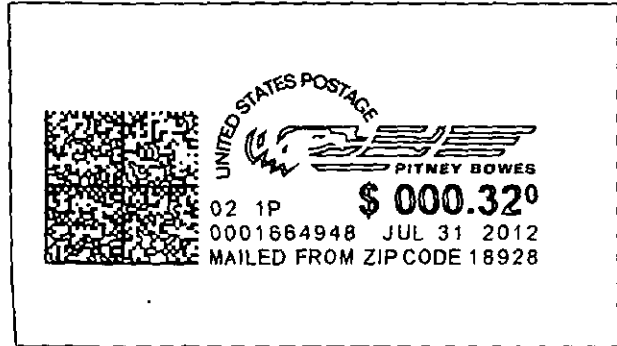

Sec Bur
Commonwealth of Pennsylvania
PA Public Utility Commission
Tariff Section
Attn: David Thompson
P.O. Box 3265
Harrisburg, PA 17105-3265