

March 2, 2015

VIA OVERNIGHT DELIVERY

Rosemary Chiavetta, Secretary
Pennsylvania Public Utility Commission
Commonwealth Keystone Building
400 North Street, Second Floor
Harrisburg, Pennsylvania 17120

RECEIVED

MAR 2 2015

PA PUBLIC UTILITY COMMISSION
SECRETARY'S BUREAU

**Re: Letter of Notification Filing of West Penn Power Company for the Yukon-Smithton-Shepler Hill Junction 138 kV Transmission Line Structure Installation Project in South Huntingdon Township, Westmoreland County, Pennsylvania;
Docket No. _____**

Dear Secretary Chiavetta:

Enclosed for filing is a Letter of Notification requesting approval for the installation of a new structure on the Yukon-Smithton-Shepler Hill Junction 138 kV Transmission Line. This Letter of Notification is filed pursuant to the Commission's regulations at 52 Pa. Code §57.72(d)(1)(v). Copies of this Letter of Notification or a Notice of Filing have been served upon the parties as required by 52 Pa. Code § 57.74 and noted on the attached Certificate of Service.

West Penn Power Company requests that the Commission approve the Company's LON by the April 23, 2015 public meeting. The Company experienced a delay in obtaining the sole necessary right of way agreement. West Penn Power Company has work scheduled for May 2015 for the transmission project, which is relatively minor in terms of work scope but important for transmission purposes.

Please date stamp the additional copy, identify the assigned docket number, and return it to me in the enclosed, postage-prepaid envelope. If you have questions pertaining to this matter do not hesitate to contact me.

Rosemary Chiavetta, Secretary
Page 2
March 2, 2015

If you have any questions pertaining to this matter, please do not hesitate to contact me.

Very truly yours,

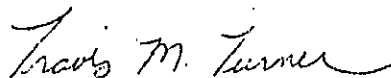

Travis M. Turner, Engineer III
FirstEnergy Service Company
5001 NASA Blvd.
Fairmont, WV 26554
(304) 534-7456
tturner@firstenergycorp.com

Enclosures

cc: Paul Diskin - Bureau of Technical Utility Services (via UPS)
Yasmin Snowberger – Bureau of Technical Utility Services (via UPS)

**BEFORE THE
PENNSYLVANIA PUBLIC UTILITY COMMISSION**

RECEIVED

MAR 2 2015

PA PUBLIC UTILITY COMMISSION
SECRETARY'S BUREAU

**LETTER OF NOTIFICATION OF WEST
PENN POWER COMPANY FOR THE
YUKON-SMITHTON-SHEPLER HILL
JUNCTION 138 KV TRANSMISSION LINE
STRUCTURE INSTALLATION PROJECT
IN SOUTH HUNTINGDON TOWNSHIP,
WESTMORELAND COUNTY,
PENNSYLVANIA**

:
:
:
:
:
:
:
:
:
:
:

Docket No. _____

**LETTER OF NOTIFICATION FILING FOR THE
YUKON-SMITHTON-SHEPLER HILL JUNCTION
138 KV TRANSMISSION LINE STRUCTURE
INSTALLATION PROJECT**

To The Pennsylvania Public Utility Commission:

West Penn Power Company ("West Penn"), a FirstEnergy company, submits a Letter of Notification for the installation of a new structure within an existing transmission line right-of-way. In support thereof West Penn submits as follows:

1. Pursuant to 52 Pa. Code §57.72(d) West Penn submits this Letter of Notification ("LON") requesting that the Pennsylvania Public Utility Commission ("Commission") approve the Yukon-Smithton-Shepler Hill Junction 138 kV Transmission Line Structure Installation Project ("Project") as described herein. The Project falls within Commission regulations at 52 Pa. Code §57.72(d)(1)(v), pertaining to a line that is to be reconstructed so as not to substantially alter the right of way, thus allowing the utility to file a LON in lieu of a full siting application.

2. West Penn is a public utility subject to the jurisdiction of the Commission over the siting and construction of transmission lines pursuant to Chapter 57, Subchapter G, of the Commission's regulations. 52 Pa. Code §57.71 et seq.

The address of West Penn's principal business office is:

West Penn Power Company
800 Cabin Hill Drive
Greensburg, PA 15601

3. This Letter of Notification filing consists of the following:

- Letter of Notification
- **Exhibit No. 1** – General Location of Project
- **Exhibit No. 2** – General Layout of the Project
- **Exhibit No. 3** – Structure
- Certificate of Service

4. The attorney representing West Penn in this matter authorized to receive notices and communications on its behalf is:

John L. Munsch
FirstEnergy Service Company
800 Cabin Hill Drive
Greensburg, PA 15601
(724) 838-6210
Pa. Attorney ID #31489

5. West Penn also requests that a copy of all notices and communications regarding this matter be sent to:

Travis M. Turner, Engineer
Energy Delivery, Transmission and Substation Engineering
FirstEnergy Service Company
5001 NASA Blvd.
Fairmont, WV 26554
(304) 534-7456

6. The proposed Project is located in South Huntingdon Township, Westmoreland County, approximately 0.17 miles southwest of the intersection of Fitz Henry Road and Wilkinson Road.

General Description of the Proposed Project:

7. West Penn proposes to install one (1) wood H-frame dead-end tangent structure with an approximate pole height of 70 feet, as shown in **Exhibit 3**, within the existing right-of-way of the Yukon-Smithton-Shepler Hill Junction 138 kV Transmission Line between two existing structures. The existing conductor and shield wire will remain. A topographic map of the area showing the location of the Project is attached hereto and incorporated herein as **Exhibit 1**. The general layout of the Project is provided in **Exhibit 2**.

8. The Project will be constructed on an existing West Penn right-of-way with a minor alteration of an individual right of way agreement. All necessary rights of way have been obtained by West Penn.

9. Attached hereto as **Exhibits 1** through **3**, and made part hereof, are:

- **Exhibit 1** shows the general location of the Project on a map which is a partial copy of the United States Geologic Survey, Westmoreland and Fayette County, Quadrangle; 40079-B6.
- **Exhibit 2** shows the general layout of the Project.
- **Exhibit 3** shows the configuration for the 138 kV wood H-frame dead-end tangent structure.

Statement of Need:

10. This Project is needed to increase the rating of the Yukon-Smithton-Shepler Hill Junction 138 kV Transmission Line. Installing the new structure increases clearance at the location to allow the transmission line to operate up to temperature of 212°F. Presently, the conductor is limited to 167°F due to clearance. Increasing the conductor operating temperature from 167°F to 212°F increases the conductor rating from 234/297 MVA (summer normal/summer emergency) to 308/376 MVA (summer normal/summer emergency). The line rating increase is necessary to mitigate Planning Criteria violations identified by FirstEnergy and PJM.

The Project is needed to ensure the West Penn transmission system can be operated reliably under NERC Category C5 multiple circuit tower line (i.e. “common structure”) outage conditions. Specifically, loss of the Yukon-Charleroi #1 and Yukon-Charleroi #2 138 kV lines results in an overload (approximately 108%) of the Smithton-Shepler Hill Junction section of the Yukon-Smithton-Shepler Hill Junction 138 kV line. The Project mitigates the potential Planning Criteria violation and ensures compliance with FirstEnergy and PJM Transmission Planning Criteria.

PJM is the Regional Transmission Operator responsible for the reliable operation of the interconnected transmission system for the bulk electric system portion of the West Penn system. PJM is also the registered Transmission Planner for the West Penn system, and is responsible for demonstrating compliance with the NERC standards. Generator deliverability, load deliverability, and common mode tests have been developed by PJM to successfully demonstrate compliance with NERC standards.

Results of the PJM analysis have been shared with PJM stakeholders and the general public. The Project, assigned PJM baseline RTEP ID b2170, was presented to the PJM Transmission Expansion Advisory Committee (“TEAC”) on November 5, 2012, and can be found on the PJM website.¹ The TEAC Recommendations to the PJM Board, PJM Staff Whitepaper, dated December 13, 2012, can be found on the PJM website² which contains additional information regarding the need for this project.

Safety Considerations:

14. Design, construction and operation of the Project will meet or exceed the requirements specified in the latest revision of the National Electric Safety Code (“NESC”) and all applicable safety standards established by the Occupational Safety and Health Administration (“OSHA”). All work shall be done in accordance with NESC, OSHA, and any applicable local, state or federal requirements.

Construction Schedule and Cost:

15. Construction of the Project is expected to commence on or about May 1, 2015, and the proposed in-service date for the Project is June 1, 2015.

16. The cost of the Project is expected to be approximately \$ 132,000 to be assumed by West Penn.

¹ <http://www.pjm.com/committees-and-groups/committees/teac.aspx>

² <http://www.pjm.com/~media/committees-groups/committees/teac/20121213/20121213-december-2012-pjm-board-approval-of-rtep-whitepaper.ashx>

Filing Date:

17. This Letter of Notification Filing is being sent to the Commission on March 2, 2015 via overnight delivery. The filing date shall be deemed to be March 2, 2015. As required by 52 Pa. Code §§ 57.72(d)(4), West Penn states:

The Commission will review and, by order, approve or disapprove a letter of notification. If the Commission approves a letter of notification, the HV line shall be located and constructed without the application process set forth in this subletter. If the Commission does not approve the letter of notification, its order shall direct the applicant to comply with the application process set forth in this subchapter.

Certificate of Service:

18. A copy of this Letter of Notification filing will be served by certified mail upon those who are entitled to receive a copy of an application or notice of filing an application as set forth in 52 Pa. Code §§ 57.74, in accordance with the provisions of 52 Pa. Code §§ 57.72(d)(3), and as shown on the attached Certificate of Service.

WHEREFORE, West Penn Power Company respectfully requests that the Commission review and approve this Letter of Notification.

Dated: February 26, 2015

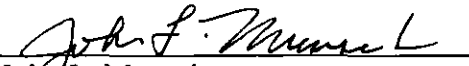
By: 
John L. Munsch
Attorney for
WEST PENN POWER COMPANY
PA Attorney No. 31489
800 Cabin Hill Drive
Greensburg, PA 15601
(724) 838-6210

MAR 2 2015

EXHIBIT 1

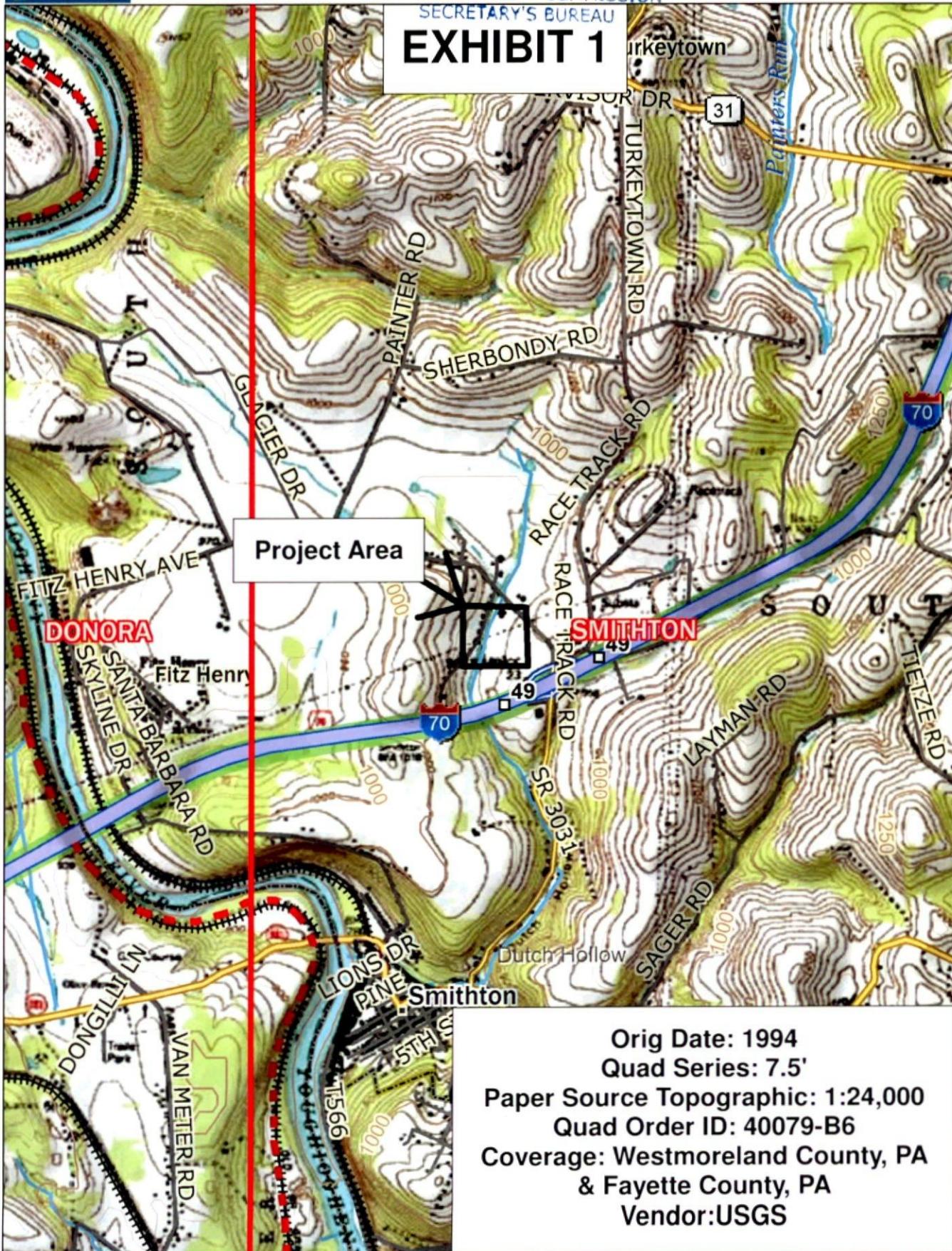

Project Area

DONORA

SMITHTON

Orig Date: 1994
 Quad Series: 7.5'
 Paper Source Topographic: 1:24,000
 Quad Order ID: 40079-B6
 Coverage: Westmoreland County, PA
 & Fayette County, PA
 Vendor: USGS

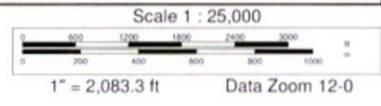
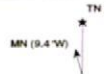



TOWNSHIP OF SOUTH HUNTINGDON
COUNTY OF WESTMORELAND
COMMONWEALTH OF PENNSYLVANIA

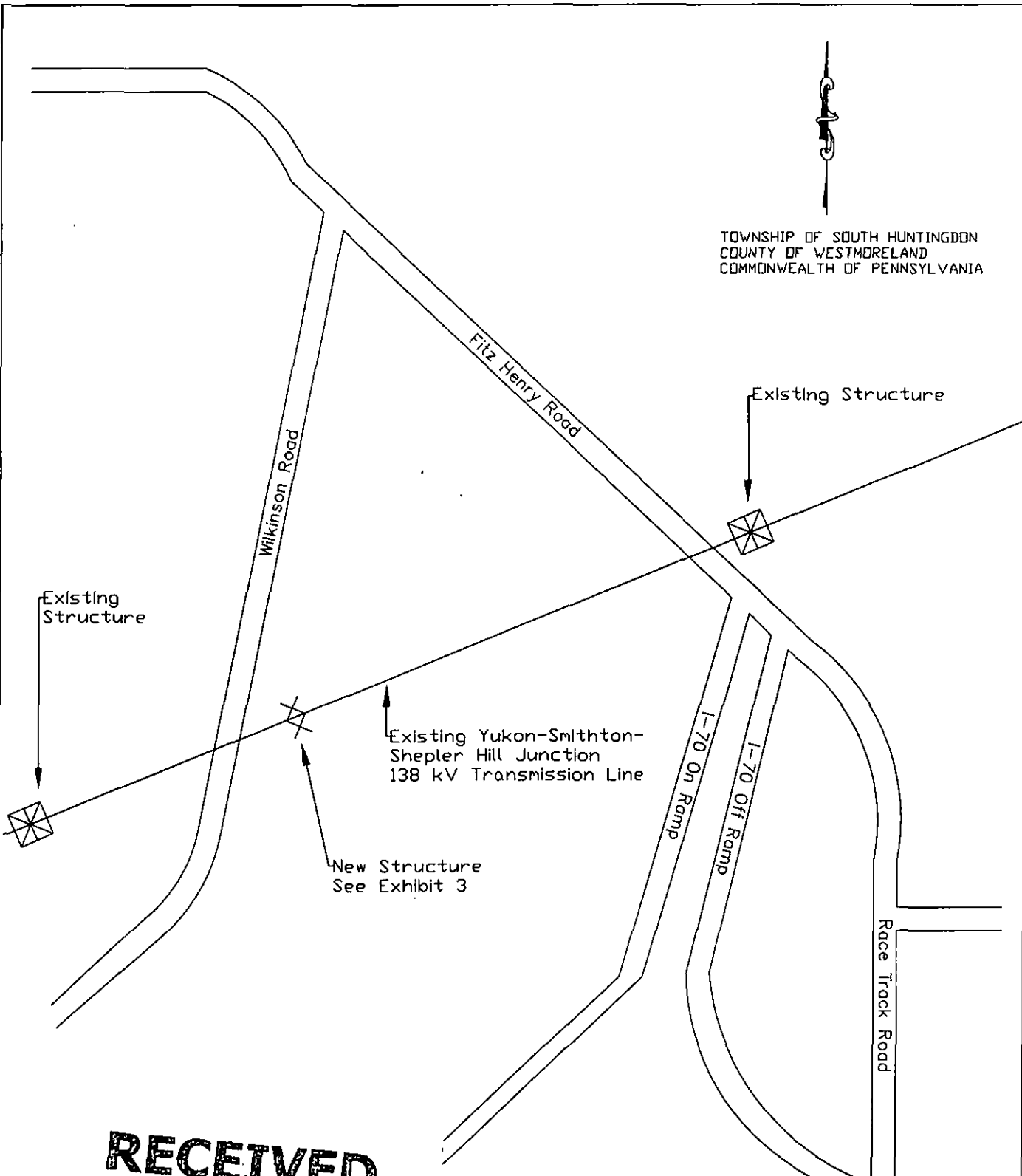

YUKON-SMITHTON-SHEPLER HILL JCT. 138 kV EX. 2

RECEIVED

MAR 2 2015

PA PUBLIC UTILITY COMMISSION
SECRETARY'S BUREAU



YUKON-SMITHTON-SHEPLER HILL JUNCTION 138 kV HV
TRANSMISSION LINE STRUCTURE INSTALLATION PROJECT

GENERAL LAYOUT

EXHIBIT 2

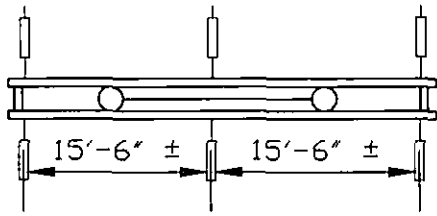

SECTION A-A

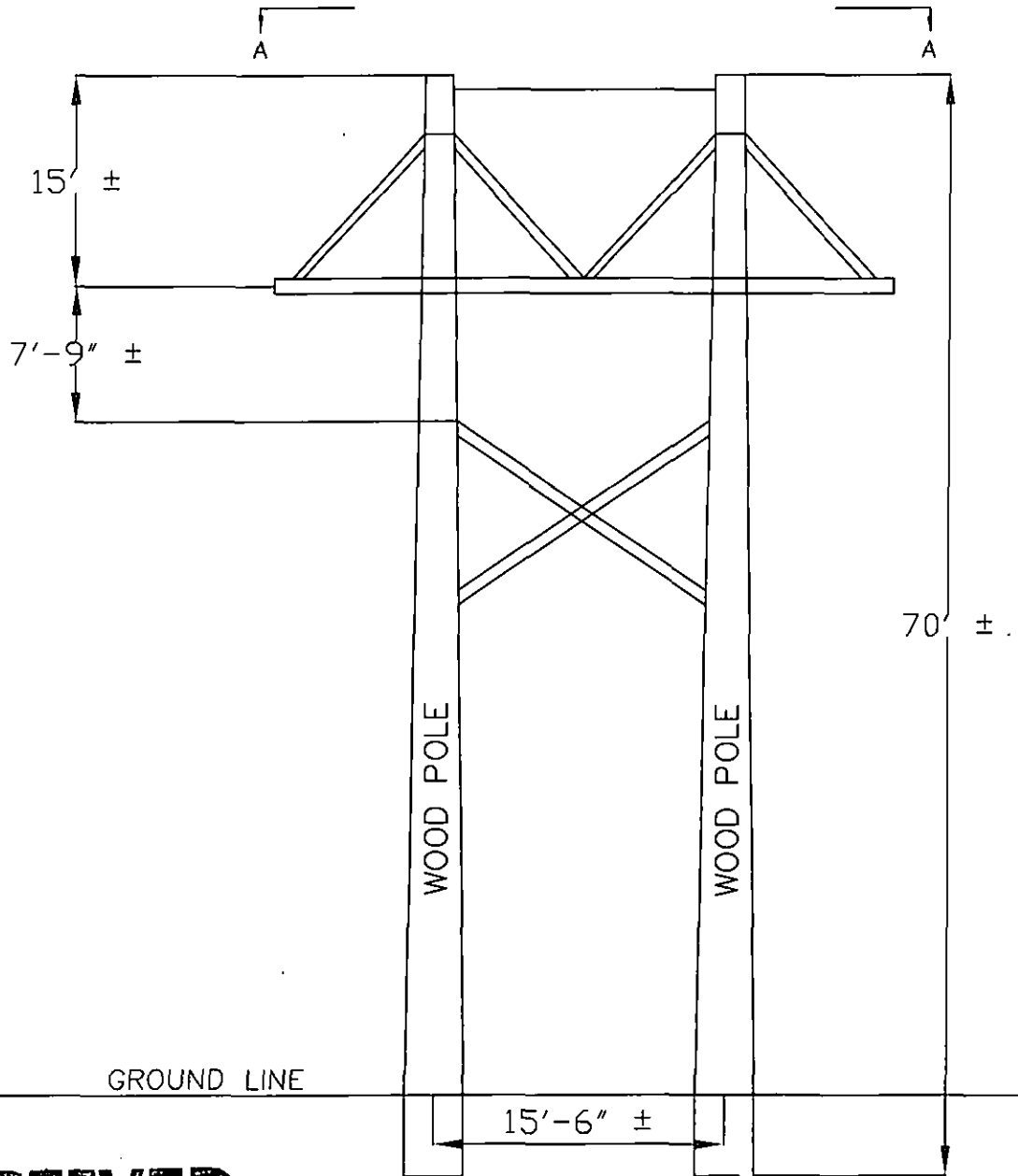

GROUND LINE

RECEIVED

MAR 2 2015

PA PUBLIC UTILITY COMMISSION
SECRETARY'S BUREAU

WestPenn™
Power
A FirstEnergy Company

YUKON-SMITHTON-SHEPLER HILL JUNCTION 138 KV
TRANSMISSION LINE STRUCTURE INSTALLATION
PROJECT

138 kv WOOD H-FRAME
DEADEND TANGENT STRUCTURE

EXHIBIT 3

YUKON-SMITHTON-SHEPLER HILL JUNCTION 138 KV EX. 3

RECEIVED

MAR 2 2015

**BEFORE THE
PENNSYLVANIA PUBLIC UTILITY COMMISSION** PA PUBLIC UTILITY COMMISSION
SECRETARY'S BUREAU

**LETTER OF NOTIFICATION OF WEST :
PENN POWER COMPANY FOR THE :
YUKON-SMITHTON-SHEPLER HILL :
JUNCTION 138 KV TRANSMISSION :
LINE STRUCTURE INSTALLATION :
PROJECT IN SOUTH HUNTINGDON :
TOWNSHIP, WESTMORELAND :
COUNTY, PENNSYLVANIA :**

Docket No.: _____

VERIFICATION

Travis M. Turner states that he is an Engineer, Transmission Siting, ROW Engineering and Surveying, for FirstEnergy Service Company; that he is authorized to make this Verification on behalf of West Penn Power Company; and that the facts set forth in the Letter of Notification are true and correct to the best of his knowledge, information and belief. He understands that the statements herein are subject to the penalties of 18 Pa.C.S. §4904 (relating to unsworn falsification to authorities).

Date: March 2, 2015

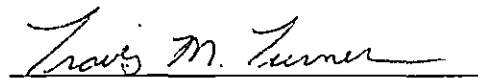
Travis M. Turner

RECEIVED

MAR 2 2015

PA PUBLIC UTILITY COMMISSION
SECRETARY'S BUREAU

**BEFORE THE
PENNSYLVANIA PUBLIC UTILITY COMMISSION**

**LETTER OF NOTIFICATION OF WEST
PENN POWER COMPANY FOR THE
YUKON-SMITHTON-SHEPLER HILL
JUNCTION 138 KV TRANSMISSION LINE
STRUCTURE INSTALLATION PROJECT
IN SOUTH HUNTINGDON TOWNSHIP,
WESTMORELAND COUNTY,
PENNSYLVANIA**

:
:
:
:
: Docket No. _____
:
:
:
:
:
:

CERTIFICATE OF SERVICE

I hereby certify that on this date, the parties listed below that are entitled to receive a Letter of Notification pursuant to 52 Pa. Code §57.72 (d) (3) were served by certified mail, return receipt requested, a copy of the above-captioned Letter of Notification Filing, and the parties listed below that are entitled to receive a Notice of Filing pursuant to 52 Pa. Code §57.72 (d) (3) were served by certified mail, return receipt requested, a copy of the Notice of Filing and a courtesy copy of the Letter of Notification.

Service by certified mail, return receipt requested, addressed as follows:

Those entitled to receive a Letter of Notification:

Pursuant to 52 Pa. Code §57.74(b)(1) - The chief executive officer, the governing body and the body charged with the duty of planning land use in each city, borough, town, township, and county in which any portion of the HV line is proposed to be located:

Mr. Eddie Troup
Chairman, South Huntingdon Township
75 Supervisor Drive
West Newton, PA 15089

Mr. Melvin Cornell
Supervisor, South Huntingdon Township
75 Supervisor Drive
West Newton, PA 15089

Mr. Richard Gates
Supervisor, South Huntingdon Township
75 Supervisor Drive
West Newton, PA 15089

Ms. Cindy Thome
Secretary, South Huntingdon
Township
75 Supervisor Drive
West Newton, PA 15089

Mr. Charles W. Anderson
Chairman, Westmoreland County
Commissioner
2 North Main Street, Suite 101
Greensburg, PA 15601

Mr. Tyler Courtney
Vice Chairman, Westmoreland County
Commissioner
2 North Main Street, Suite 101
Greensburg, PA 15601

Mr. Ted Kopas
Westmoreland County Commissioner
2 North Main Street, Suite 101
Greensburg, PA 15601

Mr. Jason Rigone
Director
Westmoreland County Planning
Commission
Fifth Floor, Suite 520
40 North Pennsylvania Ave.
Greensburg, PA 15601

Pursuant to 57.74(b)(2) - The president of the public utility, other than the applicant, in whose service territory any portion of the HV line is proposed to be located:

NOT APPLICABLE

Pursuant to 57.74(b)(3) – The Department of Environmental Resources:

Department of Environmental Protection
Attn: Bureau of Environmental Planning
Rachel Carson State Office Building
P.O. Box 2063
Harrisburg, PA 17105-2063
Attn: Office of Field Operations

Those entitled to receive a Notice of Filing:

Pursuant to 57.74(c)(1)(i) – The Secretary of the Department of Transportation:

Honorable Barry J. Schoch, P.E., Secretary
c/o Office of Chief Counsel
Pennsylvania Department of Transportation
Commonwealth Keystone Building
400 North Street, 9th Floor
Harrisburg, PA 17120
Attn: William J. Cressler

Pursuant to 52 Pa. Code §57.74(c)(1)(ii) – The Chairman of the Historical and Museum Commission:

Pennsylvania Historical & Museum Commission
Bureau for Historic Preservation
Commonwealth Keystone Building, Second Floor
400 North Street
Harrisburg, PA 17120-0053
Attn: Mr. Douglass C. McLearen, Chief

Pursuant to 52 Pa. Code §57.74(c)(1)(iii) – Other local, State or Federal agencies designated in §57.72(c)(11):

Mr. Ronald Rohall, Chairman
Westmoreland County Conservation District
Donohoe Center
218 Donohoe Road
Greensburg, PA 15601

Pursuant to 52 Pa. Code §57.74(c)(1)(iv) – Known persons, corporations and other entities of record owning property within the proposed right-of-way:

R&W Oil Products
700 Atlantic Avenue
McKeesport, PA 15132

Dated: March 2, 2015

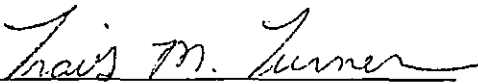
By: 
Travis M. Turner, Engineer III
FirstEnergy Service Company
5001 NASA Blvd.
Fairmont, WV 26554
(304) 534-7456
tturner@firstenergycorp.com

March 2, 2015

R&W Oil Products
700 Atlantic Avenue
McKeesport, PA 15132**LETTER OF NOTIFICATION FILING FOR THE
YUKON-SMITHTON-SHEPLER HILL JUNCTION 138 KV
TRANSMISSION LINE STRUCTURE INSTALLATION PROJECT**

Dear Sir or Madam,

Enclosed for your information, is a copy of West Penn Power Company's ("West Penn"), a FirstEnergy Corp. company, Letter of Notification for the Yukon-Smithton-Shepler Hill Junction 138 kV Transmission Line Structure Installation Project ("Project"). West Penn is a public utility providing electric distribution and transmission service subject to the jurisdiction of the Commission over the siting and construction of transmission lines pursuant to Chapter 57, Subchapter G, of the Commission's regulations. 52 Pa. Code §57.71 *et seq.*, and as such, this Project is subject to Pennsylvania Public Utility Commission jurisdiction. The Letter of Notification has been developed in the format described in Commission regulations at 52 Pa. Code §57.72(d).

As explained in the Letter of Notification, West Penn is proposing to install a new transmission line structure within the existing Yukon-Smithton-Shepler Hill Junction 138 kV Transmission Line. The proposed project is located in South Huntingdon Township, Westmoreland County Pennsylvania. The new transmission line structure will be located on existing right-of-way on your property. Exhibit 1 of the Letter of Notification is a map depicting the general location of the project.

I'll be glad to answer any questions concerning this matter. You can contact me at 304-534-7456.

Sincerely,

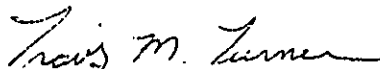
Travis M. Turner, Engineer III
FirstEnergy Service Company
5001 NASA Blvd.
Fairmont, WV 26554
(304) 534-7456
tturner@firstenergycorp.com

Attachment

March 2, 2015

Mr. Eddie Troup
Chairman, South Huntingdon Township
75 Supervisor Drive
West Newton, PA 15089

**LETTER OF NOTIFICATION FILING FOR THE
YUKON-SMITHTON-SHEPLER HILL JUNCTION 138 KV
TRANSMISSION LINE STRUCTURE INSTALLATION PROJECT**

Dear Mr. Troup,

Enclosed for your information, is a copy of West Penn Power Company's ("West Penn"), a FirstEnergy Corp. company, Letter of Notification for the Yukon-Smithton-Shepler Hill Junction 138 kV Transmission Line Structure Installation Project ("Project"). West Penn is a public utility providing electric distribution and transmission service subject to the jurisdiction of the Commission over the siting and construction of transmission lines pursuant to Chapter 57, Subchapter G, of the Commission's regulations. 52 Pa. Code §57.71 *et seq.*, and as such, this Project is subject to Pennsylvania Public Utility Commission jurisdiction. The Letter of Notification has been developed in the format described in Commission regulations at 52 Pa. Code §57.72(d).

As explained in the Letter of Notification, West Penn is proposing to install a new transmission line structure within the existing Yukon-Smithton-Shepler Hill Junction 138 kV Transmission Line. The proposed project is located in South Huntingdon Township, Westmoreland County Pennsylvania. The new transmission line structure will be located on existing right-of-way. Exhibit 1 of the Letter of Notification is a map depicting the general location of the project.

I'll be glad to answer any questions concerning this matter. You can contact me at (304) 534-7456.

Sincerely,

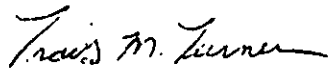

Travis M. Turner, Engineer III
FirstEnergy Service Company
5001 NASA Blvd.
Fairmont, WV 26554
(304) 534-7456

Attachment

March 2, 2015

Mr. Melvin Cornell
Supervisor, South Huntingdon Township
75 Supervisor Drive
West Newton, PA 15089

**LETTER OF NOTIFICATION FILING FOR THE
YUKON-SMITHTON-SHEPLER HILL JUNCTION 138 KV
TRANSMISSION LINE STRUCTURE INSTALLATION PROJECT**

Dear Mr. Cornell,

Enclosed for your information, is a copy of West Penn Power Company's ("West Penn"), a FirstEnergy Corp. company, Letter of Notification for the Yukon-Smithton-Shepler Hill Junction 138 kV Transmission Line Structure Installation Project ("Project"). West Penn is a public utility providing electric distribution and transmission service subject to the jurisdiction of the Commission over the siting and construction of transmission lines pursuant to Chapter 57, Subchapter G, of the Commission's regulations. 52 Pa. Code §57.71 *et seq.*, and as such, this Project is subject to Pennsylvania Public Utility Commission jurisdiction. The Letter of Notification has been developed in the format described in Commission regulations at 52 Pa. Code §57.72(d).

As explained in the Letter of Notification, West Penn is proposing to install a new transmission line structure within the existing Yukon-Smithton-Shepler Hill Junction 138 kV Transmission Line. The proposed project is located in South Huntingdon Township, Westmoreland County Pennsylvania. The new transmission line structure will be located on existing right-of-way. Exhibit 1 of the Letter of Notification is a map depicting the general location of the project.

I'll be glad to answer any questions concerning this matter. You can contact me at (304) 534-7456.

Sincerely,

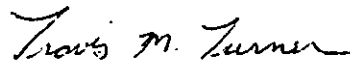

Travis M. Turner, Engineer III
FirstEnergy Service Company
5001 NASA Blvd.
Fairmont, WV 26554
(304) 534-7456

Attachment

March 2, 2015

Mr. Richard Gates
Supervisor, South Huntingdon Township
75 Supervisor Drive
West Newton, PA 15089

**LETTER OF NOTIFICATION FILING FOR THE
YUKON-SMITHTON-SHEPLER HILL JUNCTION 138 KV
TRANSMISSION LINE STRUCTURE INSTALLATION PROJECT**

Dear Mr. Gates,

Enclosed for your information, is a copy of West Penn Power Company's ("West Penn"), a FirstEnergy Corp. company, Letter of Notification for the Yukon-Smithton-Shepler Hill Junction 138 kV Transmission Line Structure Installation Project ("Project"). West Penn is a public utility providing electric distribution and transmission service subject to the jurisdiction of the Commission over the siting and construction of transmission lines pursuant to Chapter 57, Subchapter G, of the Commission's regulations. 52 Pa. Code §57.71 *et seq.*, and as such, this Project is subject to Pennsylvania Public Utility Commission jurisdiction. The Letter of Notification has been developed in the format described in Commission regulations at 52 Pa. Code §57.72(d).

As explained in the Letter of Notification, West Penn is proposing to install a new transmission line structure within the existing Yukon-Smithton-Shepler Hill Junction 138 kV Transmission Line. The proposed project is located in South Huntingdon Township, Westmoreland County Pennsylvania. The new transmission line structure will be located on existing right-of-way. Exhibit 1 of the Letter of Notification is a map depicting the general location of the project.

I'll be glad to answer any questions concerning this matter. You can contact me at (304) 534-7456.

Sincerely,

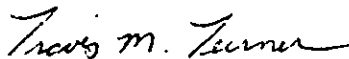

Travis M. Turner, Engineer III
FirstEnergy Service Company
5001 NASA Blvd.
Fairmont, WV 26554
(304) 534-7456

Attachment

March 2, 2015

Ms. Cindy Thome
Secretary, South Huntingdon Township
75 Supervisor Drive
West Newton, PA 15089

**LETTER OF NOTIFICATION FILING FOR THE
YUKON-SMITHTON-SHEPLER HILL JUNCTION 138 KV
TRANSMISSION LINE STRUCTURE INSTALLATION PROJECT**

Dear Ms. Thome,

Enclosed for your information, is a copy of West Penn Power Company's ("West Penn"), a FirstEnergy Corp. company, Letter of Notification for the Yukon-Smithton-Shepler Hill Junction 138 kV Transmission Line Structure Installation Project ("Project"). West Penn is a public utility providing electric distribution and transmission service subject to the jurisdiction of the Commission over the siting and construction of transmission lines pursuant to Chapter 57, Subchapter G, of the Commission's regulations. 52 Pa. Code §57.71 *et seq.*, and as such, this Project is subject to Pennsylvania Public Utility Commission jurisdiction. The Letter of Notification has been developed in the format described in Commission regulations at 52 Pa. Code §57.72(d).

As explained in the Letter of Notification, West Penn is proposing to install a new transmission line structure within the existing Yukon-Smithton-Shepler Hill Junction 138 kV Transmission Line. The proposed project is located in South Huntingdon Township, Westmoreland County Pennsylvania. The new transmission line structure will be located on existing right-of-way. Exhibit 1 of the Letter of Notification is a map depicting the general location of the project.

I'll be glad to answer any questions concerning this matter. You can contact me at (304) 534-7456.

Sincerely,

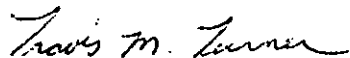

Travis M. Turner, Engineer III
FirstEnergy Service Company
5001 NASA Blvd.
Fairmont, WV 26554
(304) 534-7456

Attachment

March 2, 2015

Mr. Charles W. Anderson
Chairman, Westmoreland County Commissioner
2 North Main Street, Suite 101
Greensburg, PA 15601

**LETTER OF NOTIFICATION FILING FOR THE
YUKON-SMITHTON-SHEPLER HILL JUNCTION 138 KV
TRANSMISSION LINE STRUCTURE INSTALLATION PROJECT**

Dear Mr. Anderson,

Enclosed for your information, is a copy of West Penn Power Company's ("West Penn"), a FirstEnergy Corp. company, Letter of Notification for the Yukon-Smithton-Shepler Hill Junction 138 kV Transmission Line Structure Installation Project ("Project"). West Penn is a public utility providing electric distribution and transmission service subject to the jurisdiction of the Commission over the siting and construction of transmission lines pursuant to Chapter 57, Subchapter G, of the Commission's regulations. 52 Pa. Code §57.71 *et seq.*, and as such, this Project is subject to Pennsylvania Public Utility Commission jurisdiction. The Letter of Notification has been developed in the format described in Commission regulations at 52 Pa. Code §57.72(d).

As explained in the Letter of Notification, West Penn is proposing to install a new transmission line structure within the existing Yukon-Smithton-Shepler Hill Junction 138 kV Transmission Line. The proposed project is located in South Huntingdon Township, Westmoreland County Pennsylvania. The new transmission line structure will be located on existing right-of-way. Exhibit 1 of the Letter of Notification is a map depicting the general location of the project.

I'll be glad to answer any questions concerning this matter. You can contact me at (304) 534-7456.

Sincerely,

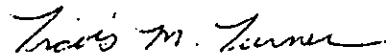

Travis M. Turner, Engineer III
FirstEnergy Service Company
5001 NASA Blvd.
Fairmont, WV 26554
(304) 534-7456

Attachment

March 2, 2015

Mr. Tyler Courtney
Vice Chairman, Westmoreland County Commissioner
2 North Main Street, Suite 101
Greensburg, PA 15601

**LETTER OF NOTIFICATION FILING FOR THE
YUKON-SMITHTON-SHEPLER HILL JUNCTION 138 KV
TRANSMISSION LINE STRUCTURE INSTALLATION PROJECT**

Dear Mr. Courtney,

Enclosed for your information, is a copy of West Penn Power Company's ("West Penn"), a FirstEnergy Corp. company, Letter of Notification for the Yukon-Smithton-Shepler Hill Junction 138 kV Transmission Line Structure Installation Project ("Project"). West Penn is a public utility providing electric distribution and transmission service subject to the jurisdiction of the Commission over the siting and construction of transmission lines pursuant to Chapter 57, Subchapter G, of the Commission's regulations. 52 Pa. Code §57.71 *et seq.*, and as such, this Project is subject to Pennsylvania Public Utility Commission jurisdiction. The Letter of Notification has been developed in the format described in Commission regulations at 52 Pa. Code §57.72(d).

As explained in the Letter of Notification, West Penn is proposing to install a new transmission line structure within the existing Yukon-Smithton-Shepler Hill Junction 138 kV Transmission Line. The proposed project is located in South Huntingdon Township, Westmoreland County Pennsylvania. The new transmission line structure will be located on existing right-of-way. Exhibit 1 of the Letter of Notification is a map depicting the general location of the project.

I'll be glad to answer any questions concerning this matter. You can contact me at (304) 534-7456.

Sincerely,

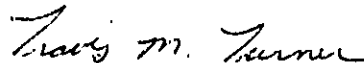

Travis M. Turner, Engineer III
FirstEnergy Service Company
5001 NASA Blvd.
Fairmont, WV 26554
(304) 534-7456

Attachment

March 2, 2015

Mr. Ted Kopas
Westmoreland County Commissioner
2 North Main Street, Suite 101
Greensburg, PA 15601

**LETTER OF NOTIFICATION FILING FOR THE
YUKON-SMITHTON-SHEPLER HILL JUNCTION 138 KV
TRANSMISSION LINE STRUCTURE INSTALLATION PROJECT**

Dear Mr. Kopas,

Enclosed for your information, is a copy of West Penn Power Company's ("West Penn"), a FirstEnergy Corp. company, Letter of Notification for the Yukon-Smithton-Shepler Hill Junction 138 kV *Transmission Line Structure Installation Project* ("Project"). *West Penn is a public utility providing electric distribution and transmission service subject to the jurisdiction of the Commission over the siting and construction of transmission lines pursuant to Chapter 57, Subchapter G, of the Commission's regulations. 52 Pa. Code §57.71 et seq., and as such, this Project is subject to Pennsylvania Public Utility Commission jurisdiction. The Letter of Notification has been developed in the format described in Commission regulations at 52 Pa. Code §57.72(d).*

As explained in the Letter of Notification, West Penn is proposing to install a new transmission line structure within the existing Yukon-Smithton-Shepler Hill Junction 138 kV Transmission Line. The proposed project is located in South Huntingdon Township, Westmoreland County Pennsylvania. The new transmission line structure will be located on existing right-of-way. Exhibit 1 of the Letter of Notification is a map depicting the general location of the project.

I'll be glad to answer any questions concerning this matter. You can contact me at (304) 534-7456.

Sincerely,

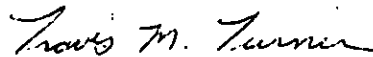

Travis M. Turner, Engineer III
FirstEnergy Service Company
5001 NASA Blvd.
Fairmont, WV 26554
(304) 534-7456

Attachment

March 2, 2015

Mr. Jason Rigone
Director
Westmoreland County Planning Commission
Fifth Floor, Suite 520
40 North Pennsylvania Ave.
Greensburg, PA 15601

**LETTER OF NOTIFICATION FILING FOR THE
YUKON-SMITHTON-SHEPLER HILL JUNCTION 138 KV
TRANSMISSION LINE STRUCTURE INSTALLATION PROJECT**

Dear Mr. Rigone,

Enclosed for your information, is a copy of West Penn Power Company's ("West Penn"), a FirstEnergy Corp. company, Letter of Notification for the Yukon-Smithton-Shepler Hill Junction 138 kV Transmission Line Structure Installation Project ("Project"). West Penn is a public utility providing electric distribution and transmission service subject to the jurisdiction of the Commission over the siting and construction of transmission lines pursuant to Chapter 57, Subchapter G, of the Commission's regulations. 52 Pa. Code §57.71 *et seq.*, and as such, this Project is subject to Pennsylvania Public Utility Commission jurisdiction. The Letter of Notification has been developed in the format described in Commission regulations at 52 Pa. Code §57.72(d):

As explained in the Letter of Notification, West Penn is proposing to install a new transmission line structure within the existing Yukon-Smithton-Shepler Hill Junction 138 kV Transmission Line. The proposed project is located in South Huntingdon Township, Westmoreland County Pennsylvania. The new transmission line structure will be located on existing right-of-way. Exhibit 1 of the Letter of Notification is a map depicting the general location of the project.

I'll be glad to answer any questions concerning this matter. You can contact me at (304) 534-7456.

Sincerely,

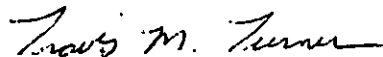

Travis M. Turner, Engineer III
FirstEnergy Service Company
5001 NASA Blvd.
Fairmont, WV 26554
(304) 534-7456

Attachment

March 2, 2015

Department of Environmental Protection
Attn: Bureau of Environmental Planning
Rachel Carson State Office Building
P.O. Box 2063
Harrisburg, PA 17105-2063
Attn: Office of Field Operations

**LETTER OF NOTIFICATION FILING FOR THE
YUKON-SMITHTON-SHEPLER HILL JUNCTION 138 KV
TRANSMISSION LINE STRUCTURE INSTALLATION PROJECT**

Dear Sir or Madam,

Enclosed for your information, is a copy of West Penn Power Company's ("West Penn"), a FirstEnergy Corp. company, Letter of Notification for the Yukon-Smithton-Shepler Hill Junction 138 kV Transmission Line Structure Installation Project ("Project"). West Penn is a public utility providing electric distribution and transmission service subject to the jurisdiction of the Commission over the siting and construction of transmission lines pursuant to Chapter 57, Subchapter G, of the Commission's regulations. 52 Pa. Code §57.71 *et seq.*, and as such, this Project is subject to Pennsylvania Public Utility Commission jurisdiction. The Letter of Notification has been developed in the format described in Commission regulations at 52 Pa. Code §57.72(d).

As explained in the Letter of Notification, West Penn is proposing to install a new transmission line structure within the existing Yukon-Smithton-Shepler Hill Junction 138 kV Transmission Line. The proposed project is located in South Huntingdon Township, Westmoreland County Pennsylvania. The new transmission line structure will be located on-existing right-of-way. Exhibit I of the Letter of Notification is a map depicting the general location of the project.

I'll be glad to answer any questions concerning this matter. You can contact me at (304) 534-7456.

Sincerely,

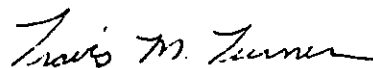

Travis M. Turner, Engineer III
FirstEnergy Service Company
5001 NASA Blvd.
Fairmont, WV 26554
(304) 534-7456

Attachment

March 2, 2015

Honorable Barry J. Schoch, P.E., Secretary
c/o Office of Chief Counsel
Pennsylvania Department of Transportation
Commonwealth Keystone Building
400 North Street, 9th Floor
Harrisburg, PA 17120
Attn: William J. Cressler

**LETTER OF NOTIFICATION FILING FOR THE
YUKON-SMITHTON-SHEPLER HILL JUNCTION 138 KV
TRANSMISSION LINE STRUCTURE INSTALLATION PROJECT**

Dear Mr. Cressler,

Enclosed for your information, is a copy of West Penn Power Company's ("West Penn"), a FirstEnergy Corp. company, Letter of Notification for the Yukon-Smithton-Shepler Hill Junction 138 kV Transmission Line Structure Installation Project ("Project"). West Penn is a public utility providing electric distribution and transmission service subject to the jurisdiction of the Commission over the siting and construction of transmission lines pursuant to Chapter 57, Subchapter G, of the Commission's regulations. 52 Pa. Code §57.71 *et seq.*, and as such, this Project is subject to Pennsylvania Public Utility Commission jurisdiction. The Letter of Notification has been developed in the format described in Commission regulations at 52 Pa. Code §57.72(d).

As explained in the Letter of Notification, West Penn is proposing to install a new transmission line structure within the existing Yukon-Smithton-Shepler Hill Junction 138 kV Transmission Line. The proposed project is located in South Huntingdon Township, Westmoreland County Pennsylvania. The new transmission line structure will be located on existing right-of-way. Exhibit 1 of the Letter of Notification is a map depicting the general location of the project.

I'll be glad to answer any questions concerning this matter. You can contact me at (304) 534-7456.

Sincerely,

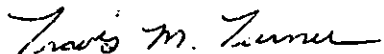

Travis M. Turner, Engineer III
FirstEnergy Service Company
5001 NASA Blvd.
Fairmont, WV 26554
(304) 534-7456

Attachment

March 2, 2015

Pennsylvania Historical & Museum Commission
Bureau for Historic Preservation
Commonwealth Keystone Building, Second Floor
400 North Street
Harrisburg, PA 17120-0053
Attn: Mr. Douglass C. McLearen, Chief

**LETTER OF NOTIFICATION FILING FOR THE
YUKON-SMITHTON-SHEPLER HILL JUNCTION 138 KV
TRANSMISSION LINE STRUCTURE INSTALLATION PROJECT**

Dear Mr. McLearen,

Enclosed for your information, is a copy of West Penn Power Company's ("West Penn"), a FirstEnergy Corp. company, Letter of Notification for the Yukon-Smithton-Shepler Hill Junction 138 kV Transmission Line Structure Installation Project ("Project"). West Penn is a public utility providing electric distribution and transmission service subject to the jurisdiction of the Commission over the siting and construction of transmission lines pursuant to Chapter 57, Subchapter G, of the Commission's regulations. 52 Pa. Code §57.71 *et seq.*, and as such, this Project is subject to Pennsylvania Public Utility Commission jurisdiction. The Letter of Notification has been developed in the format described in Commission regulations at 52 Pa. Code §57.72(d).

As explained in the Letter of Notification, West Penn is proposing to install a new transmission line structure within the existing Yukon-Smithton-Shepler Hill Junction 138 kV Transmission Line. The proposed project is located in South Huntingdon Township, Westmoreland County Pennsylvania. The new transmission line structure will be located on existing right-of-way. Exhibit 1 of the Letter of Notification is a map depicting the general location of the project.

I'll be glad to answer any questions concerning this matter. You can contact me at (304) 534-7456.

Sincerely,

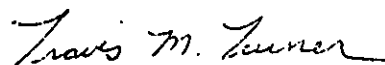

Travis M. Turner, Engineer III
FirstEnergy Service Company
5001 NASA Blvd.
Fairmont, WV 26554
(304) 534-7456

Attachment

March 2, 2015

Mr. Ronald Rohall, Chairman
Westmoreland County Conservation District
Donohoe Center
218 Donohoe Road
Greensburg, PA 15601

**LETTER OF NOTIFICATION FILING FOR THE
YUKON-SMITHTON-SHEPLER HILL JUNCTION 138 KV
TRANSMISSION LINE STRUCTURE INSTALLATION PROJECT**

Dear Mr. Rohall,

Enclosed for your information, is a copy of West Penn Power Company's ("West Penn"), a FirstEnergy Corp. company, Letter of Notification for the Yukon-Smithton-Shepler Hill Junction 138 kV Transmission Line Structure Installation Project ("Project"). West Penn is a public utility providing electric distribution and transmission service subject to the jurisdiction of the Commission over the siting and construction of transmission lines pursuant to Chapter 57, Subchapter G, of the Commission's regulations. 52 Pa. Code §57.71 *et seq.*, and as such, this Project is subject to Pennsylvania Public Utility Commission jurisdiction. The Letter of Notification has been developed in the format described in Commission regulations at 52 Pa. Code §57.72(d).

As explained in the Letter of Notification, West Penn is proposing to install a new transmission line structure within the existing Yukon-Smithton-Shepler Hill Junction 138 kV Transmission Line. The proposed project is located in South Huntingdon Township, Westmoreland County Pennsylvania. The new transmission line structure will be located on existing right-of-way. Exhibit 1 of the Letter of Notification is a map depicting the general location of the project.

I'll be glad to answer any questions concerning this matter. You can contact me at (304) 534-7456.

Sincerely,

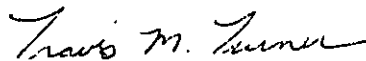

Travis M. Turner, Engineer III
FirstEnergy Service Company
5001 NASA Blvd.
Fairmont, WV 26554
(304) 534-7456

Attachment



5001 NASA Blvd Fairmont, WV 26554

Rosemary Chiavetta, Secretary
Pennsylvania Public Utility Commission
Commonwealth Keystone Building
400 North Street, Second Floor
Harrisburg, Pennsylvania 17120

Call 1-800-PICK-UPS® (1-800-742-5877) or visit UPS.com®

Domestic Shipments

- To qualify for the letter rate, UPS Express Envelopes may only contain correspondence, urgent documents, and/or electronic media, and must weigh 8 oz. or less. UPS Express Envelopes containing items other than those listed or weighing more than 8 oz. will be billed by weight.

International Shipments

- The UPS Express Envelope may be used only for documents of no commercial value. Certain countries consider electronic media as documents. Visit ups.com/intportexport to verify if your shipment is classified as a document.

© 2015 United States Postal Service. All rights reserved. Envelope must weigh 8 oz. or less.

TRAVIS TURNER
304-534-7331
MON POWER REGIONAL HQ
5001 NASA BLVD
FAIRMONT WV 265548218

0.8 LBS LTR 1 OF 1

SHIP TO:

ATTN: ROSEMARY CHIAVETTA, SECRETARY
PA PUBLIC UTILITY COMMISSION
400 NORTH STREET, SECOND FLOOR
COMMONWEALTH KEYSTONE BUILDING
HARRISBURG PA 17120-0093

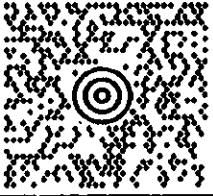

PA 171 9-20



UPS NEXT DAY AIR

1

TRACKING #: 1Z X30 79V 01 9236 7003

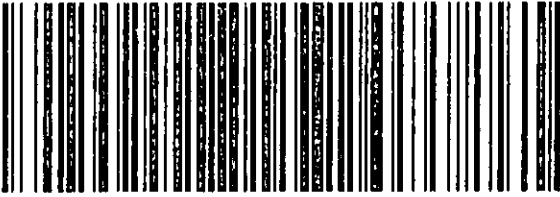

BILLING: P/P

Accounting: 509132

CS 12.1.04 WWP100 60 0A 01/2015



CMPC

To: CHIAVETA, R. PUC

Agency: PUC
Floor:
External Carrier: UPS 1 DAY AIR

3/3/2015 10:21:10 AM



1Z X3079V0192367003

This envelope is for use

UPS Next Day Air®
UPS Worldwide Express®
UPS 2nd Day Air®

Do not use this envelope for:

UPS Ground
UPS Standard
UPS 3 Day Select®

s side.