

G.

**BEFORE
PENNSYLVANIA PUBLIC UTILITY COMMISSION**

In re: Application of the Gettysburg & Northern Railroad approval of the signaling restoration of the crossing #593409R where Hanover Street crosses at grade the tracks of Gettysburg & Northern Railroad, located in the Biglerville Borough of Adams County, Pennsylvania.

Application
Docket No.

To Pennsylvania Public Utility Commission:

1. The name and address of applicant are
Gettysburg & Northern Railroad

750 Mummasburg Road, Gettysburg, PA 17325
2. The name and address of applicant's attorney are
Bradley Gordon

10752 Deerwood Park Blvd Suite 300, Jacksonville, FL 32256
3. The proposed crossing falls under the Gettysburg State and Private Investments Driving Economic Recovery (SPIDER) Project, which is publicly funded under the Consolidated Rail Infrastructure and Safety Improvement Program (CRISI) and privately funded under Patriot Rail Company. This project aims to rehabilitate general road crossing signaling. The crossing located at Hanover Street, is primarily traffic signaling and restoration of crossing appurtenances. No utility work is planned for this crossing location.
4. The intent for the crossing located at Hanover Street, is to be rehabilitated with new cross-buck signs, (2) new 2-way assemblies, new mounting arms, new backgrounds, new electronic bells, and new LED flashers with hoods. No utility work is planned for this crossing location.
5. Local businesses, such as the Dr. Pepper distribution center may be minimally impacted due to flagging for approaching train traffic. However, the business shall not anticipate a crossing outage to restore crossing signal appurtenances. Traffic may be required to detour by using York Street or Old Carlisle Road, but is not likely required.
6. The annual average daily traffic (AADT) was considered by using 2020 U.S. DOT Crossing Inventory data provided by the Federal Railroad Administration. County. Daily traffic volume accounts for 2,385.
7. Expenses associated with the Hanover Street grade crossing include traffic control, traffic control appurtenances, removal/replacement of cross-bucks, remove/replacement of new (2) 2-way assemblies, remove/replacement of new

electronic bells and removal/replacement of new LED flashers. The CRISI Grant Program and the Patriot Rail Company are to provide funding for this project.

8. The (construction, alteration, relocation, abolition or suspension) is necessary or proper for the following reasons

To promote safer traffic flow along with enhancing railroad operations and safety.

Wherefore, applicant prays your Honorable Commission to approve the application:

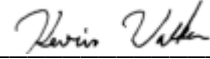

(Signature of Applicant)

G.

§ 1.36. Verification.

(a) Applications, petitions, formal complaints, motions and answers thereto containing an averment of fact not appearing of record in the action or containing a denial of fact shall be personally verified by a party thereto or by an authorized officer of the party if a corporation or association. Verification means a signed written statement of fact supported by oath or affirmation or made subject to the penalties of 18 Pa. C.S. §4904 (relating to unsworn falsification to authorities). If verification is required, notarization is not necessary.

(b) The Verification form should comply substantially with the following:

VERIFICATION

I, Kevin Walker, hereby state that the facts above set forth are true and correct (or are true and correct to the best of my knowledge, information and belief) and that I expect to be able to prove the same at a hearing held in this matter. I understand that the statements herein are made subject to the penalties of 18 Pa. C.S. § 4904 (relating to unsworn falsification to authorities).

Date: 6/22/2023

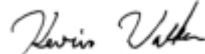

(Signature)

CERTIFICATE OF SERVICE

I hereby certify that I have this day served a true copy of the foregoing document upon the participants, listed below, in accordance with the requirements of § 1.54

- **Pennsylvania Department of Transportation**

Daniel D. Leonard, P.E. | Grade Crossing Engineer
PA Department of Transportation | Bureau of Project Delivery
Highway Delivery Division | Utilities and Right-of-Way Section
400 North Street, 7th Floor | Harrisburg, PA 17120
danleonard@pa.gov

- **PennDOT Office of Chief Counsel**

Karen L. Cummings | Senior Assistant Counsel
Governor's Office of General Counsel
Department of Transportation
Office of Chief Counsel | Real Property Division
P.O. Box 8212 | Harrisburg, PA 17105-8212
kcummings@pa.gov

Donald Smith | Acting Chief Counsel
Department of Transportation
Office of Chief Counsel | Real Property Division
P.O. Box 8212 | Harrisburg, PA 17105-8212
dojsmith@pa.gov

- **PennDOT District Office 8-0**

Ahmed Lasloudji | District Grade Crossing Engineer
2140 Herr St
Harrisburg, PA 17103-1699
alasloudji@pa.gov

- **Gettysburg & Northern Railway**

Derek Metts | Public Projects Engineer
Patriot Rail Company
10752 Deerwood Park Blvd., Suite 300
Jacksonville, FL 32256
derek.metts@patriotrail.com

Kevin Walker | Principal Engineer
CSR Engineering
2010 Highway 49E
Pleasant View, TN 37146
Kevin.walker@csrengineers.com

- **Federal Railroad Administration**

Frank Frey
1200 New Jersey Avenue, SE
RRS-23, new W33-447
Washington, DC 20590
frank.frey@dot.gov

- **Adams County**

Randy Phiel | President / Chairperson
Commissioners Office
117 Baltimore St, Room 201
Gettysburg, PA 17325
rphiel@adamscountypa.gov

- **Adams Electric Cooperative, Inc.**

Chad Thoman | Engineering
1338 Biglerville Road P.O. Box 1055
Gettysburg, PA 17325-1055
chadt@adamsec.ccop

Dated this 24th day of July, 2023



(Signature)

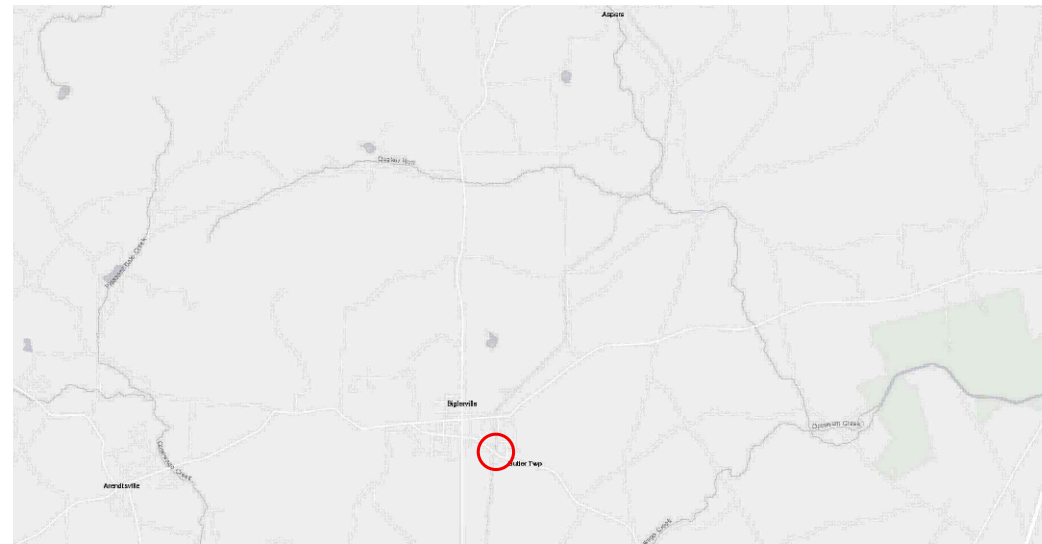

CROSSING LOCATION MAP

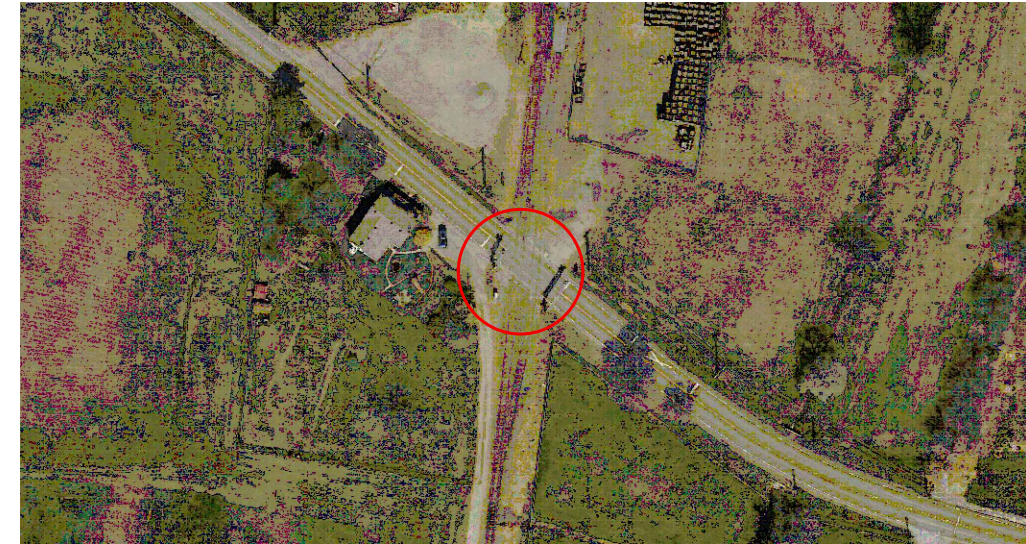

AERIAL VIEW OF CROSSING

PROJECT:
GETTYSBURG STATE AND PRIVATE INVESTMENTS DRIVING ECONOMIC RECOVERY (SPIDER) PROJECT

ROAD NAME: **HANOVER STREET**

ROUTE #:

FRA CROSS. #: **593409R**

AGENCY:

RAILROAD: **GETTYSBURG AND NORTHERN**

MILEPOST: **23.67**

AADT: **2020-02385**

COORDINATES: **LONG. -77.2434
LAT. 39.9266**

NEAREST TOWN: **BILGERSVILLE, PA**

EXISTING CROSSING

SURFACE:

RAIL SIZE:

WIDTH:

PROPOSED CROSSING

SURFACE:

RAIL SIZE:

WIDTH:

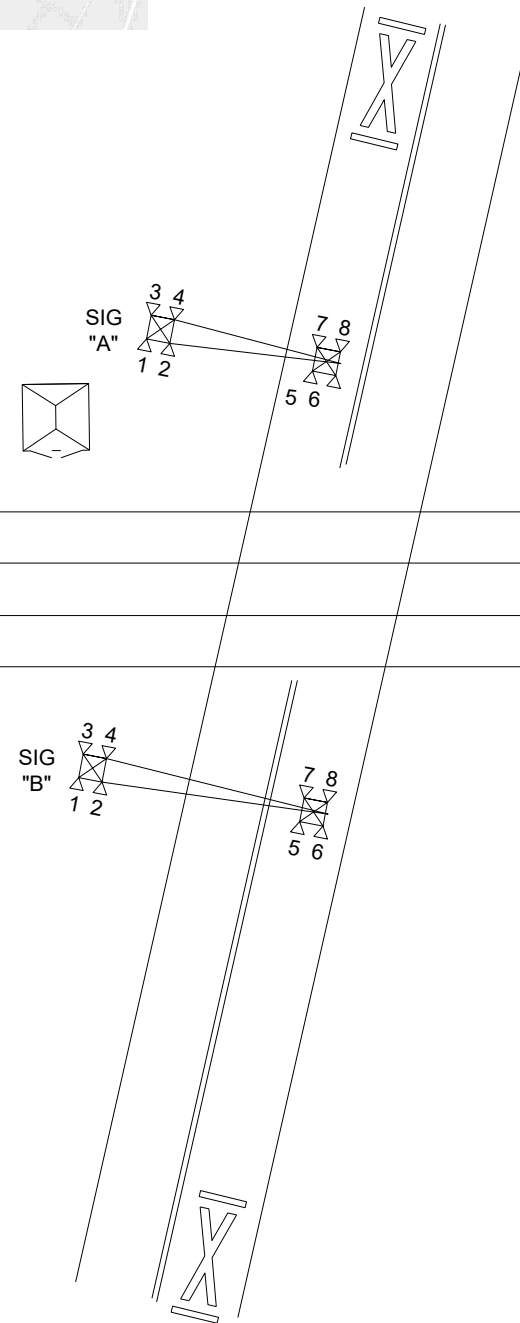
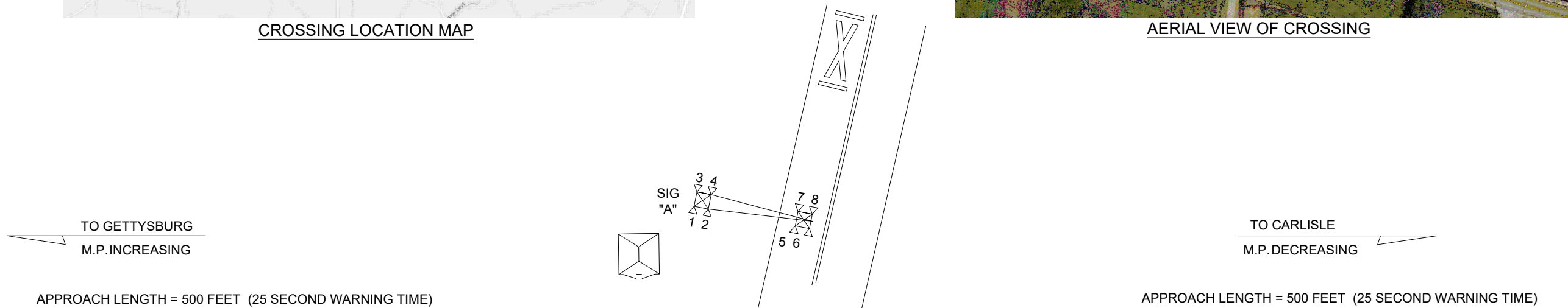
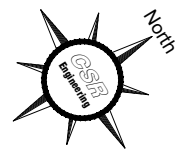

SCOPE OF WORK:

- 1) REMOVE EXISTING CROSS-BUCKS AND INSTALL NEW CROSS-BUCKS
- 2) REMOVE EXISTING BELLS AND INSTALL NEW ELECTRONIC BELLS
- 3) REMOVE EXISTING FLASHERS (2) 2-WAY ASSEMBLIES AND INSTALL ON THE EXISTING MAST: NEW (4) 2-WAY ASSEMBLIES
NEW LED FLASHERS WITH HOODS, 24 INCH BACKGROUNDS AND MOUNTING ARMS



LOOKING SOUTHEAST

REVISIONS:	△
	△
	△

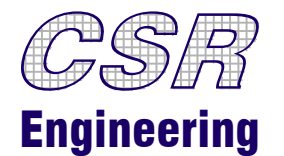

JOB #:	20-255	DRAWN BY:	DKH
DATE:	6-23	CHECKED BY:	KCW
SCALE:	NONE	SHEET #:	11 OF 16

U. S. DOT CROSSING INVENTORY FORM

DEPARTMENT OF TRANSPORTATION
FEDERAL RAILROAD ADMINISTRATION

OMB No. 2130-0017

Instructions for the initial reporting of the following types of new or previously unreported crossings: For public highway-rail grade crossings, complete the entire inventory Form. For private highway-rail grade crossings, complete the Header, Parts I and II, and the Submission Information section. For public pathway grade crossings (including pedestrian station grade crossings), complete the Header, Parts I and II, and the Submission Information section. For Private pathway grade crossings, complete the Header, Parts I and II, and the Submission Information section. For grade-separated highway-rail or pathway crossings (including pedestrian station crossings), complete the Header, Part I, and the Submission Information section. For changes to existing data, complete the Header, Part I Items 1-3, and the Submission Information section, in addition to the updated data fields. Note: For private crossings only, Part I Item 20 and Part III Item 2.K. are required unless otherwise noted. An asterisk * denotes an optional field.

A. Revision Date (MM/DD/YYYY) 11 / 11 / 2022	B. Reporting Agency <input checked="" type="checkbox"/> Railroad <input type="checkbox"/> Transit <input type="checkbox"/> State <input type="checkbox"/> Other	C. Reason for Update (Select only one) <input checked="" type="checkbox"/> Change in Data <input type="checkbox"/> New Crossing <input type="checkbox"/> Closed <input type="checkbox"/> Re-Open <input type="checkbox"/> Date Change Only <input type="checkbox"/> Change in Primary Operating RR	D. DOT Crossing Inventory Number 593409R
---	--	---	--

Part I: Location and Classification Information

1. Primary Operating Railroad Gettysburg and Northern Railroad [GET]		2. State PENNSYLVANIA		3. County ADAMS	
4. City / Municipality <input checked="" type="checkbox"/> In <input type="checkbox"/> Near BIGLERVILLE		5. Street/Road Name & Block Number Hanover Street (Street/Road Name) * (Block Number)		6. Highway Type & No. SR0394	
7. Do Other Railroads Operate a Separate Track at Crossing? <input type="checkbox"/> Yes <input checked="" type="checkbox"/> No If Yes, Specify RR			8. Do Other Railroads Operate Over Your Track at Crossing? <input type="checkbox"/> Yes <input checked="" type="checkbox"/> No If Yes, Specify RR		
9. Railroad Division or Region <input checked="" type="checkbox"/> None		10. Railroad Subdivision or District <input checked="" type="checkbox"/> None		11. Branch or Line Name <input checked="" type="checkbox"/> None	
12. RR Milepost 0023.670 (prefix) (nnnn.nnn) (suffix)		13. Line Segment * system		14. Nearest RR Timetable Station * BIGLERVILLE	
15. Parent RR (if applicable) <input checked="" type="checkbox"/> N/A		16. Crossing Owner (if applicable) <input checked="" type="checkbox"/> N/A		17. Crossing Type <input checked="" type="checkbox"/> Public <input type="checkbox"/> Private	
18. Crossing Purpose <input checked="" type="checkbox"/> Highway <input type="checkbox"/> Pathway, Ped. <input type="checkbox"/> Station, Ped.		19. Crossing Position <input checked="" type="checkbox"/> At Grade <input type="checkbox"/> RR Under <input type="checkbox"/> RR Over		20. Public Access (if Private Crossing) <input type="checkbox"/> Yes <input checked="" type="checkbox"/> No	
21. Type of Train <input checked="" type="checkbox"/> Freight <input type="checkbox"/> Intercity Passenger <input type="checkbox"/> Commuter		<input type="checkbox"/> Transit <input type="checkbox"/> Shared Use Transit <input type="checkbox"/> Tourist/Other		22. Average Passenger Train Count Per Day <input type="checkbox"/> Less Than One Per Day <input type="checkbox"/> Number Per Day 0	
23. Type of Land Use <input type="checkbox"/> Open Space <input type="checkbox"/> Farm <input checked="" type="checkbox"/> Residential <input type="checkbox"/> Commercial <input type="checkbox"/> Industrial <input type="checkbox"/> Institutional <input type="checkbox"/> Recreational <input type="checkbox"/> RR Yard					
24. Is there an Adjacent Crossing with a Separate Number? <input type="checkbox"/> Yes <input checked="" type="checkbox"/> No If Yes, Provide Crossing Number			25. Quiet Zone (FRA provided) <input checked="" type="checkbox"/> No <input type="checkbox"/> 24 Hr <input type="checkbox"/> Partial <input type="checkbox"/> Chicago Excused Date Established		
26. HSR Corridor ID <input checked="" type="checkbox"/> N/A		27. Latitude in decimal degrees (WGS84 std: nn.nnnnnnn) 39.9266000		28. Longitude in decimal degrees (WGS84 std: -nnn.nnnnnnn) -77.2434000	
29. Lat/Long Source <input checked="" type="checkbox"/> Actual <input type="checkbox"/> Estimated		30.A. Railroad Use *			
30.B. Railroad Use *		31.A. State Use *			
30.C. Railroad Use *		31.B. State Use *			
30.D. Railroad Use *		31.C. State Use *			
30.E. Railroad Use *		31.D. State Use *			
32.A. Narrative (Railroad Use) *			32.B. Narrative (State Use) *		
33. Emergency Notification Telephone No. (posted) 800-914-3808		34. Railroad Contact (Telephone No.) 800-914-3808		35. State Contact (Telephone No.) 717-772-3079	

Part II: Railroad Information

1. Estimated Number of Daily Train Movements				
1.A. Total Day Thru Trains (6 AM to 6 PM) 2	1.B. Total Night Thru Trains (6 PM to 6 AM) 0	1.C. Total Switching Trains 0	1.D. Total Transit Trains 0	1.E. Check if Less Than One Movement Per Day <input type="checkbox"/> How many trains per week? _____
2. Year of Train Count Data (YYYY) 2022		3. Speed of Train at Crossing 3.A. Maximum Timetable Speed (mph) 10 3.B. Typical Speed Range Over Crossing (mph) From 1 to 10		
4. Type and Count of Tracks Main 1 Siding 1 Yard 0 Transit 0 Industry 0				
5. Train Detection (Main Track only) <input type="checkbox"/> Constant Warning Time <input type="checkbox"/> Motion Detection <input type="checkbox"/> AFO <input type="checkbox"/> PTC <input checked="" type="checkbox"/> DC <input type="checkbox"/> Other <input type="checkbox"/> None				
6. Is Track Signaled? <input type="checkbox"/> Yes <input checked="" type="checkbox"/> No		7.A. Event Recorder <input type="checkbox"/> Yes <input checked="" type="checkbox"/> No		7.B. Remote Health Monitoring <input type="checkbox"/> Yes <input checked="" type="checkbox"/> No

U. S. DOT CROSSING INVENTORY FORM

A. Revision Date (MM/DD/YYYY) 11/11/2022		PAGE 2			D. Crossing Inventory Number (7 char.) 593409R	
Part III: Highway or Pathway Traffic Control Device Information						
1. Are there Signs or Signals? <input type="checkbox"/> Yes <input checked="" type="checkbox"/> No		2. Types of Passive Traffic Control Devices associated with the Crossing				
2.A. Crossbuck Assemblies (count) 2		2.B. STOP Signs (R1-1) (count) 0	2.C. YIELD Signs (R1-2) (count) 0	2.D. Advance Warning Signs (Check all that apply; include count) <input type="checkbox"/> None <input checked="" type="checkbox"/> W10-1 2 <input type="checkbox"/> W10-3 _____ <input type="checkbox"/> W10-11 _____ <input type="checkbox"/> W10-2 _____ <input type="checkbox"/> W10-4 _____ <input type="checkbox"/> W10-12 _____		
2.E. Low Ground Clearance Sign (W10-5) <input type="checkbox"/> Yes (count _____) <input checked="" type="checkbox"/> No		2.F. Pavement Markings <input checked="" type="checkbox"/> Stop Lines <input type="checkbox"/> Dynamic Envelope <input checked="" type="checkbox"/> RR Xing Symbols <input type="checkbox"/> None		2.G. Channelization Devices/Medians <input type="checkbox"/> All Approaches <input type="checkbox"/> Median <input type="checkbox"/> One Approach <input type="checkbox"/> None		2.H. EXEMPT Sign (R15-3) <input type="checkbox"/> Yes <input type="checkbox"/> No
2.I. ENS Sign (I-13) Displayed <input checked="" type="checkbox"/> Yes <input type="checkbox"/> No		2.J. Other MUTCD Signs <input type="checkbox"/> Yes <input type="checkbox"/> No Specify Type _____ Count 1 Specify Type _____ Count 1 Specify Type _____ Count _____		2.K. Private Crossing Signs (if private) <input type="checkbox"/> Yes <input type="checkbox"/> No	2.L. LED Enhanced Signs (List types)	
3. Types of Train Activated Warning Devices at the Grade Crossing (specify count of each device for all that apply)						
3.A. Gate Arms (count) Roadway 0 Pedestrian _____		3.B. Gate Configuration <input type="checkbox"/> 2 Quad <input type="checkbox"/> Full (Barrier) Resistance <input type="checkbox"/> 3 Quad <input type="checkbox"/> Median Gates <input type="checkbox"/> 4 Quad		3.C. Cantilevered (or Bridged) Flashing Light Structures (count) Over Traffic Lane 2 <input type="checkbox"/> Incandescent Not Over Traffic Lane 0 <input type="checkbox"/> LED		3.D. Mast Mounted Flashing Lights (count of masts) 4 <input checked="" type="checkbox"/> Incandescent <input type="checkbox"/> LED <input type="checkbox"/> Back Lights Included <input type="checkbox"/> Side Lights Included
3.E. Total Count of Flashing Light Pairs 8		3.F. Installation Date of Current Active Warning Devices: (MM/YYYY) _____/_____/_____ <input type="checkbox"/> Not Required		3.G. Wayside Horn <input type="checkbox"/> Yes Installed on (MM/YYYY) ____/____/_____ <input checked="" type="checkbox"/> No		3.H. Highway Traffic Signals Controlling Crossing <input type="checkbox"/> Yes <input checked="" type="checkbox"/> No
3.I. Bells (count) 1		3.J. Non-Train Active Warning <input type="checkbox"/> Flagging/Flagman <input type="checkbox"/> Manually Operated Signals <input type="checkbox"/> Watchman <input type="checkbox"/> Floodlighting <input type="checkbox"/> None			3.K. Other Flashing Lights or Warning Devices Count 0 Specify type _____	
4.A. Does nearby Hwy Intersection have Traffic Signals? <input type="checkbox"/> Yes <input checked="" type="checkbox"/> No		4.B. Hwy Traffic Signal Interconnection <input checked="" type="checkbox"/> Not Interconnected <input type="checkbox"/> For Traffic Signals <input type="checkbox"/> For Warning Signs	4.C. Hwy Traffic Signal Preemption <input type="checkbox"/> Simultaneous <input type="checkbox"/> Advance	5. Highway Traffic Pre-Signals <input type="checkbox"/> Yes <input type="checkbox"/> No Storage Distance * _____ Stop Line Distance * _____		6. Highway Monitoring Devices (Check all that apply) <input type="checkbox"/> Yes - Photo/Video Recording <input type="checkbox"/> Yes - Vehicle Presence Detection <input type="checkbox"/> None
Part IV: Physical Characteristics						
1. Traffic Lanes Crossing Railroad Number of Lanes 2		<input type="checkbox"/> One-way Traffic <input type="checkbox"/> Two-way Traffic <input type="checkbox"/> Divided Traffic	2. Is Roadway/Pathway Paved? <input checked="" type="checkbox"/> Yes <input type="checkbox"/> No		3. Does Track Run Down a Street? <input type="checkbox"/> Yes <input checked="" type="checkbox"/> No	4. Is Crossing Illuminated? (Street lights within approx. 50 feet from nearest rail) <input checked="" type="checkbox"/> Yes <input type="checkbox"/> No
5. Crossing Surface (on Main Track, multiple types allowed) Installation Date * (MM/YYYY) ____/____/_____ <input type="checkbox"/> 1 Timber <input checked="" type="checkbox"/> 2 Asphalt <input type="checkbox"/> 3 Asphalt and Timber <input type="checkbox"/> 4 Concrete <input type="checkbox"/> 5 Concrete and Rubber <input type="checkbox"/> 6 Rubber <input type="checkbox"/> 7 Metal <input type="checkbox"/> 8 Unconsolidated <input type="checkbox"/> 9 Composite <input type="checkbox"/> 10 Other (specify) _____						
6. Intersecting Roadway within 500 feet? <input type="checkbox"/> Yes <input type="checkbox"/> No If Yes, Approximate Distance (feet) _____			7. Smallest Crossing Angle <input type="checkbox"/> 0° - 29° <input type="checkbox"/> 30° - 59° <input type="checkbox"/> 60° - 90°		8. Is Commercial Power Available? * <input checked="" type="checkbox"/> Yes <input type="checkbox"/> No	
Part V: Public Highway Information						
1. Highway System <input type="checkbox"/> (01) Interstate Highway System <input type="checkbox"/> (02) Other Nat Hwy System (NHS) <input type="checkbox"/> (03) Federal AID, Not NHS <input checked="" type="checkbox"/> (08) Non-Federal AID		2. Functional Classification of Road at Crossing <input checked="" type="checkbox"/> (0) Rural <input type="checkbox"/> (1) Urban <input type="checkbox"/> (1) Interstate <input type="checkbox"/> (5) Major Collector <input type="checkbox"/> (2) Other Freeways and Expressways <input type="checkbox"/> (3) Other Principal Arterial <input checked="" type="checkbox"/> (6) Minor Collector <input type="checkbox"/> (4) Minor Arterial <input type="checkbox"/> (7) Local			3. Is Crossing on State Highway System? <input checked="" type="checkbox"/> Yes <input type="checkbox"/> No	
4. Highway Speed Limit 35 _____ MPH <input type="checkbox"/> Posted <input type="checkbox"/> Statutory		5. Linear Referencing System (LRS Route ID) *				
6. LRS Milepost *						
7. Annual Average Daily Traffic (AADT) Year 2020 _____ AADT 2385		8. Estimated Percent Trucks 5 _____ %		9. Regularly Used by School Buses? <input type="checkbox"/> Yes <input type="checkbox"/> No Average Number per Day 0 _____		10. Emergency Services Route <input type="checkbox"/> Yes <input type="checkbox"/> No
Submission Information - This information is used for administrative purposes and is not available on the public website.						
Submitted by _____ Organization _____ Phone _____ Date _____						
Public reporting burden for this information collection is estimated to average 30 minutes per response, including the time for reviewing instructions, searching existing data sources, gathering and maintaining the data needed and completing and reviewing the collection of information. According to the Paperwork Reduction Act of 1995, a federal agency may not conduct or sponsor, and a person is not required to, nor shall a person be subject to a penalty for failure to comply with, a collection of information unless it displays a currently valid OMB control number. The valid OMB control number for information collection is 2130-0017. Send comments regarding this burden estimate or any other aspect of this collection, including for reducing this burden to: Information Collection Officer, Federal Railroad Administration, 1200 New Jersey Ave. SE, MS-25 Washington, DC 20590.						